



HV10 Series Frequency Inverter User Manual

HNC Electric Limited

Content

I. Technical indicators and specifications of products.....	2
1.2 Model description	4
1.3 Rated data	4
1.4 Peripherals	5
II. Inverter Installation and Wiring.....	6
2.1 Matters needing attention for Installation.....	6
2.2 Outline drawing	7
2.3 Basic operation wiring	9
2.4 Terminal for controlling loop	9
2.5 Matters needing attention for Wiring.....	11
III. Operation and Display	12
3.1 Operation panel description	12
3.1.1 Operation panel illustration	12
3.1.2 Key Description	12
3.1.3 Function indicator description	12
3.2 Operating procedures	13
3.2.1 Parameter settings	13
3.2.2 Fault reset	13
1.RTU mode and format	14
2.Description of reading and writing function code:	14
3.Register address.....	14
4.Description of parameter address of communication protocol:	14
5. 03H Reading function mode:	16
6. 06H write function mode	17
V. Exceptions and Handling	19
VI. Parameters instructions	20
VII. Parameter description	35
00 group-basic operating parameters	35
01 group-auxiliary operating parameters	40
02 group-analog and digital input and output parameters	46
03 group -PID parameters	53
04 group -advanced functions parameters	57
05 Group- Protective Function parameters	60
06 group: communication parameters	63
07 Group- supplementary Function parameters	65
Warranty agreement	70

I. Technical indicators and specifications of products

Input	Rated voltage Frequency	Three-phase (G3/G4 series) 380V-480V, 50/60HZ Single&Three-phase (G1-2/G2 series) 220 V: 50/60 Hz Single -phase (G1-1 series) 120 V: 50/60 Hz		
	Allowable range of voltage variation	Three-phase (G3 series) : AC 380~440 (-15%~+10%) Three-phase (G4 series) : AC 460~480 (-15%~+10%) Single&Three-phase (G11-2/G2 series) : AC220V±15% Single -phase (G1-1 series) :AC120 V±15%		
Output	Voltage	G1-1 series :0~220V; G1-2/G2 series; 0~220V, G3 series; 0~440 V, G4 series; 0~480 V		
	Frequency	0~999.9HZ		
	Overload capacity	110% long-term; 150% 1 minute; 180% 5 seconds		
Control mode		V/F control, Vector control		
Control characteristic	Frequency setting resolution	Analog input	0.1% of the maximum output frequency	
		Digital settings	0.1HZ	
	Frequency accuracy	Analog input	Within 0.2% of the maximum output frequency	
		Digital input	Within 0.01% of the set output frequency	
	V/F control	V/F curve (voltage frequency characteristic)	Three ways: the first is linear torque characteristic curve, the second is square torque characteristic curve, and the third is user-set V/F curve	
		Torque boost	Manual setting: 0.0 ~ 30.0% of rated output Automatic lifting: automatically determine the boost torque according to the output current and motor parameters	
		Automatic current and voltage limiting	Whether in acceleration, deceleration or stable operation, the motor stator current and voltage can be automatically detected, which can be suppressed within the allowable range according to the unique algorithm to minimize the possibility of system fault tripping	
	Sensorless vector control	voltage frequency characteristic	Automatically adjust output voltage-frequency ratio according to motor parameters and unique algorithm	
		Torque characteristic	Starting torque: 100% rated torque at 0.5Hz (V/F control) 150% rated torque at 0.5Hz (Vector control)	
		Current and voltage suppression	Full-range current closed-loop control, completely avoiding current impact, with perfect overcurrent and overvoltage suppression function	
Undervoltage suppression during operation	Especially for users with low grid voltage and frequent fluctuation of grid voltage, the system can maintain the longest possible operation time according to the unique algorithm and residual energy allocation strategy even in the range below the allowable voltage			
Typical function	Multi-stage speed operation	7-stage programmable multi-stage speed control and multiple operation modes are optional.		
	PID control RS485 communication	Built-in PID controller (preset frequency). Standard configuration RS485 communication function, multiple communication protocols can be selected, with linkage synchronous control function		
	Frequency setting	Analog input	DC voltage 0 ~ 10 V, DC current 0 ~ 20 mA (upper and lower limits are optional)	
		Digital input	Operation panel setting, RS485 interface setting, UP/DW terminal setting, and various combination settings with analog input can also be made.	
	Output signal	Digital output	1 OC output and 1 relay output (TA,TC), with up to 17 functions	
		Analog output	1 AO, the output range can be flexibly set between 0 ~ 20mA or 0 ~ 10V, which can realize the output such as set frequency and output frequency.etc	
	Automatic voltage stabilizing operation	According to the needs, three modes can be selected: dynamic voltage stabilization, static voltage stabilization and non-voltage stabilization, so as to obtain the most stable operation effect		
Acceleration / deceleration time setting	0.1S~999.9min can be set continuously			
Brake	Energy consumption	Energy consumption braking starting voltage, return difference voltage and energy consumption braking rate can be continuously adjusted		

	braking	
	DC brake	Starting frequency of DC braking during stop: 0.00 ~ [00.05] upper limit frequency Braking time: 0.0 ~ 30.0s; Braking current: 0.0% ~ 50.0% of rated voltage of motor
	Low noise operation	The carrier frequency is continuously adjustable from 2.0 kHz to 20.0 kHz to minimize the noise of the motor
	Counter	One internal counter is convenient for system integration
Display	Operating function	Upper and lower limit frequency setting, frequency jump operation, reverse operation limit, slip frequency compensation, RS485 communication, frequency increment and decrement control, fault self-recovery operation, etc
	Running status	Output frequency, output current, output voltage, motor speed, set frequency, module temperature, PID setting, PID feedback , analog input and output, etc
	Alarm content	Record a number of operating parameters such as output frequency, set frequency, output current, output voltage, DC voltage and module temperature during the latest fault
Protection function		Overcurrent, overvoltage, undervoltage, module failure, electronic thermal relay, overheating, short circuit, internal memory failure, etc.
Environment	Ambient temperature	-10°C ~ +40°C (when the ambient temperature is 40°C ~ 50°C, please use it at a reduced level)
	Ambient humidity	5% ~ 95% RH, no water condensation
	Surrounding environment	Indoor (no direct sunlight, corrosion, flammable gas, oil mist, dust, etc.)
	Altitude	Derating for use above 1000 meters, every 1000 meters up derating 10%
Structure	Protection grade	IP20
	Cooling mode	Air-cooled with fan control

1.2 Model description

1.2.1 Naming rule

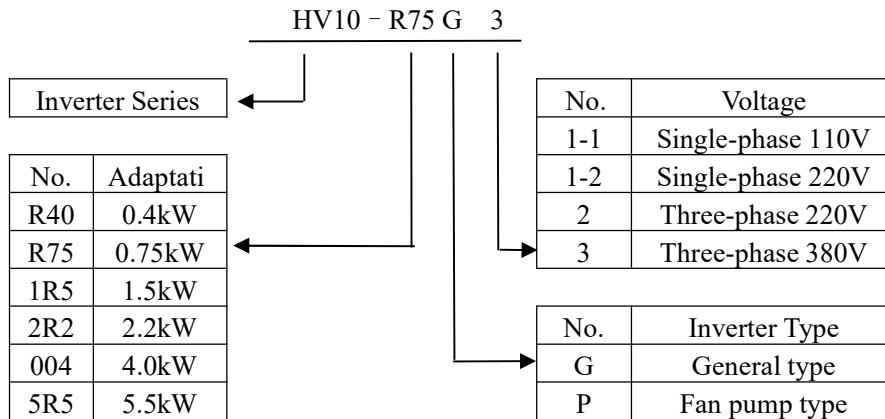

1.2.2 Nameplate

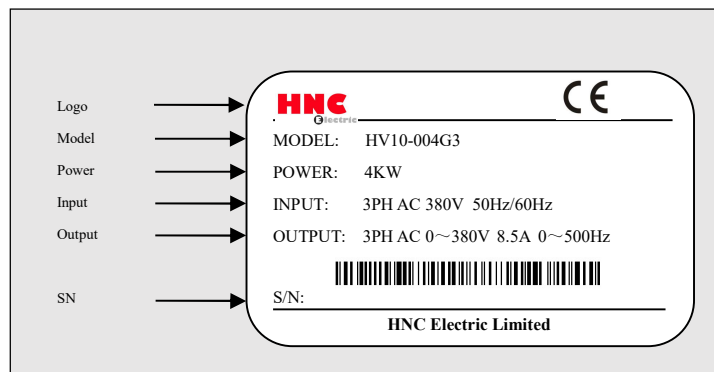

1.3 Rated data

Model	Power supply capacity (KVA)	Input current (A)	Output current (A)	Adaptive motor (kW HP)	
Single phase: AC220V(-15%)~230V(+10%), 50/60Hz					
HV10-R40G1-2	1.7	6.5	2.5	0.4	0.5
HV10-R75G1-2	3.0	11.0	4.2	0.75	1
HV10-1R5G1-2	4.8	18.0	8.0	1.5	2
HV10-2R2G1-2	7.1	27.0	10.0	2.2	3
Three phase: AC220V(-15%)~230V(+10%), 50/60Hz					
HV10-R40G2	1	2.7	2.5	0.4	0.5
HV10-R75G2	1.5	4.9	4.2	0.75	1
HV10-1R5G2	3.0	9.0	8.0	1.5	2
HV10-2R2G2	4.0	15.0	10.0	2.2	3
HV10-004G2	6.0	20.0	16.0	4.0	5
Three phase: AC380V(-15%)~440V(+10%), 50/60Hz					
HV10-R75G3	1.5	4.5	2.5	0.75	1
HV10-1R5G3	3.0	5.5	4.2	1.5	2
HV10-2R2G3	4.0	6.5	5.0	2.2	3
HV10-004G3	5.9	11.0	8.5	4.0	5
HV10-5R5G3	7.0	16.0	13.0	5.5	7

1.4 Peripherals

Model	MCCB (A)	Contactora (A)	Recommended input side main circuit wire (mm ²)	Torque wrench (N·m)	Recommended output side main circuit wire (mm ²)	Recommended control circuit wire (mm ²) mm ²
HV10-R40G1-2	10	9	0.75	0.87	0.75	0.5
HV10-R75G1-2	16	12	1.5	0.87	0.75	0.5
HV10-1R5G1-2	32	25	2.5	0.87	1.5	0.5
HV10-2R2G1-2	40	32	4.0	0.87	2.5	0.5
HV10-R40G2	10	9	0.75	0.87	0.75	0.5
HV10-R75G2	10	12	1.5	0.87	1.5	0.5
HV10-1R5G2	25	16	2.5	0.87	2.5	0.5
HV10-2R2G2	32	25	2.5	0.87	2.5	0.5
HV10-004G2	32	32	4.0	0.87	4.0	0.5
HV10-R75G3	10	9	0.75	0.87	0.75	0.5
HV10-1R5G3	10	9	1.5	0.87	0.75	0.5
HV10-2R2G3	10	9	2.5	0.87	1.5	0.5
HV10-004G3	16	12	4.0	0.87	2.5	0.5
HV10-5R5G3	25	16	4.0	0.87	4.0	0.5

II. Inverter Installation and Wiring

2.1 Matters needing attention for Installation

 Danger	
1. Before wiring, please confirm that the input power supply has been cut off.	Danger of electric shock and fire.
2. Ask electrical engineering professionals for wiring operations.	Danger of electric shock and fire.
3. The grounding terminal must be grounded reliably.	Danger of electric shock and fire.
4. After the emergency stop terminal is connected, check whether its action is effective.	There is a danger of injury. (the wiring responsibility shall be borne by the user)
5. Do not touch the output terminal directly. The output terminal of the frequency inverter is directly connected with the motor. Do not short circuit between output terminals.	Danger of electric shock and short circuit.
6. Before power-on, be sure to install the terminal cover. When removing the cover, always disconnect the power supply first.	There is danger of electric shock!
7. Cut off the power supply, and wait for 5 to 8 minutes for the remaining power in the machine to be basically discharged before carrying out inspection and maintenance.	Danger of residual voltage on electrolytic capacitor.
8. Do not carry out inspection and maintenance for non-professional technicians.	There is danger of electric shock!

 Attention	
1. Please confirm whether the power supply voltage of incoming line is consistent with the rated input voltage of frequency inverter.	There is danger of injury and fire.
2. Please connect the braking resistor or braking unit according to the wiring diagram.	Danger of fire.
3. It is best to use a screwdriver and wrench with specified torque to fasten the terminals.	Danger of fire.
4. Do not connect the input power cord to the output U, V and W terminals.	Voltage applied to the output terminal will cause internal damage of the frequency inverter
5. Do not remove the front panel cover, only the terminal cover needs to be removed when wiring.	May cause internal damage to the inverter.

2.2 Outline drawing

A. Overall dimensions of keypad

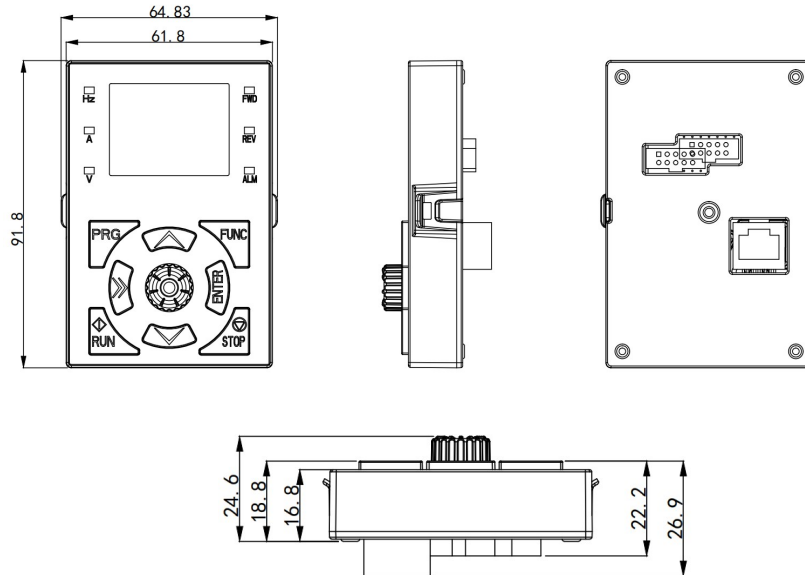

Keyboard housing dimensions:

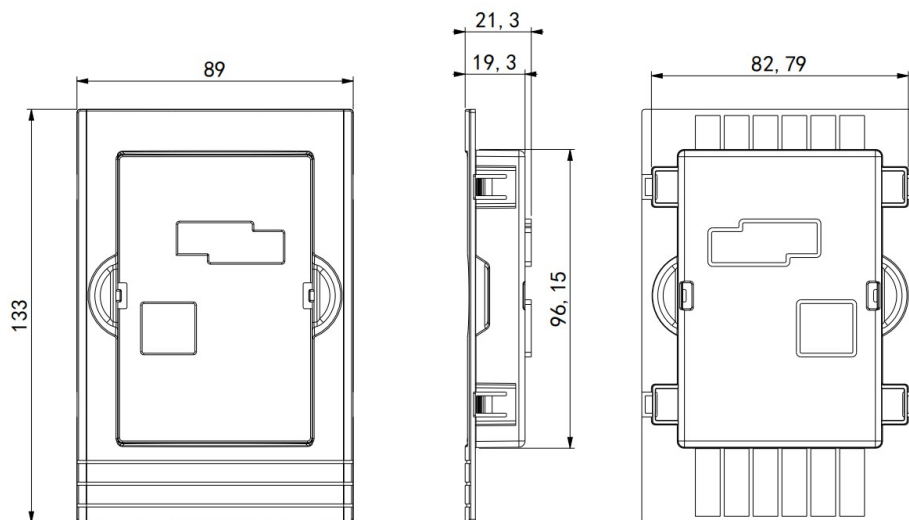

b. Overall dimensions of the whole machine

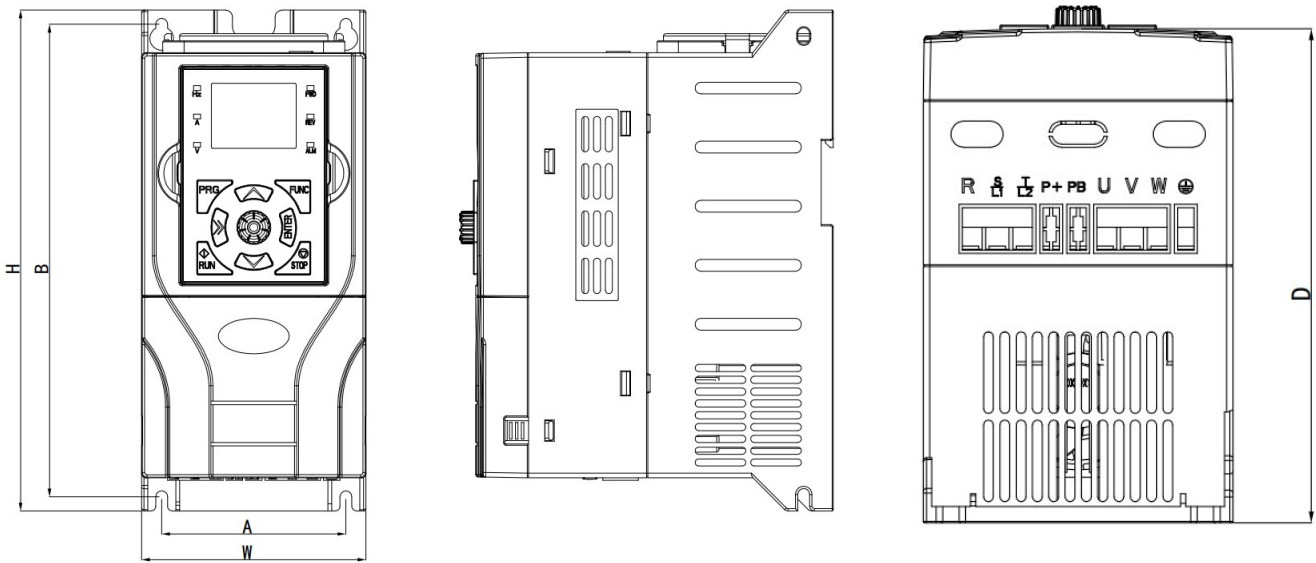

Voltage level	Model	Outline construction and installation dimension (mm)						Weight (kg)
		W	H1	D	W1	H2	Mounting hole(d)	
1PH 120V	HV10-R40G1-1	60	160	134	78	170	4	0.9
	HV10-R75G1-1							
	HV10-1R5G1-1							
	HV10-2R2G1-1							
1PH 220V	HV10-R40G1-2							
	HV10-R75G1-2							
	HV10-1R5G1-2							
	HV10-2R2G1-2							
3PH 220V	HV10-R40G2							
	HV10-R75G2							
	HV10-1R5G2							
	HV10-2G2G2							
	HV10-R75G3							
	HV10-1R5G3							
	HV10-2R2G3							
	HV10-004G3	78	200	152	95	212	4	1.3
HV10-5R5G3								

2.3 Basic operation wiring

The wiring part of the frequency inverter is divided into the main circuit and the control circuit. The user can open the cover of the output/input terminal, and the main circuit terminal and the control circuit terminal can be seen at this time. The user must connect correctly according to the wiring circuit shown below.

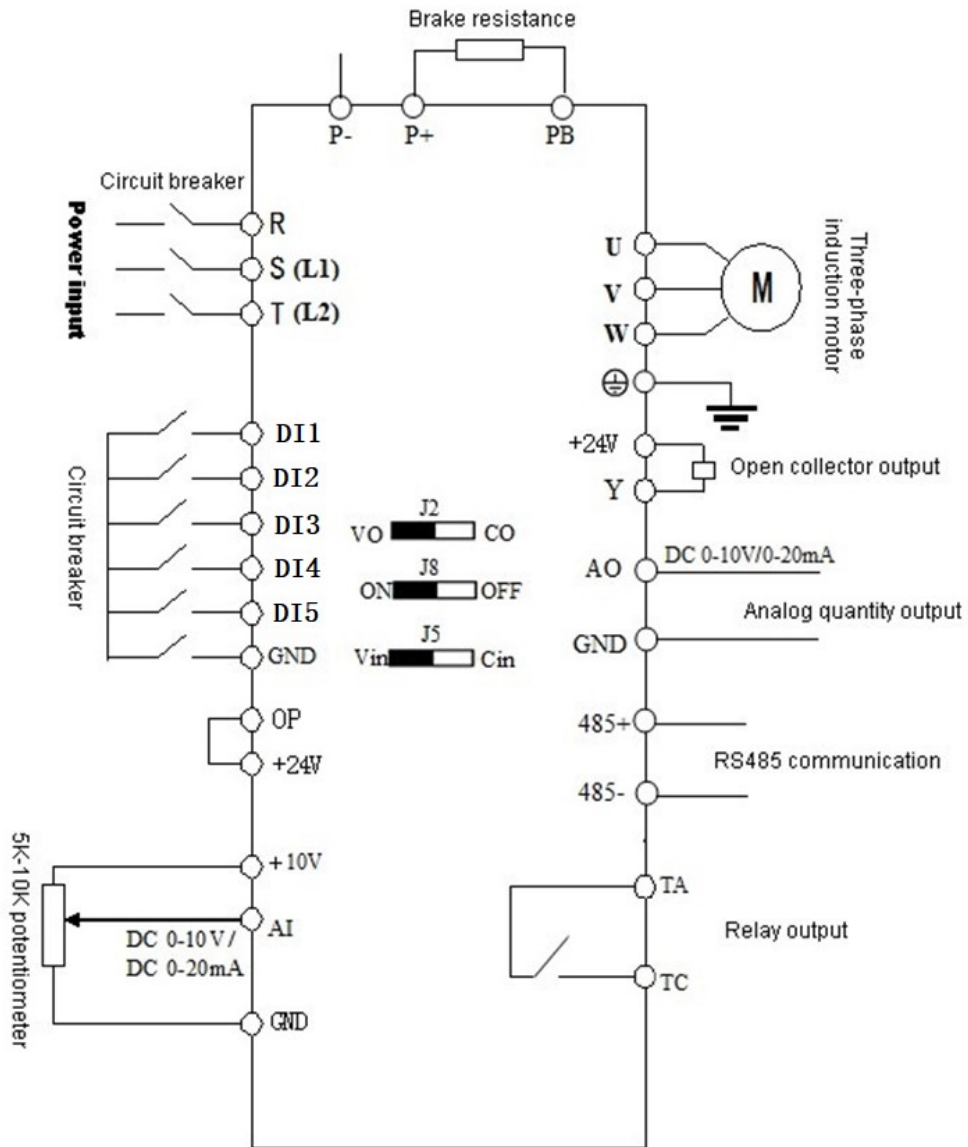

2.4 terminal for controlling loop

+10v	AI	AO	DI1	DI2	DI3	DI4	DI5	TC
GND	485+	485-	Y	+24V	GND	OP	+24V	TA

	Terminal	Function Description	Specification
Multifunctional DI	DI1	The factory default is valid when DI (DI1, DI2, DI3, DI4, DI5) and GND are short-circuited when OP and 24V are short-circuited.	INPUT, 24V level signal, high level active, 5mA.
	DI2		
	DI3		
	DI4		
	DI5		
Multifunctional AI/AO	AI	AI voltage/current input, voltage and current are selected by jumper J5, the factory default is voltage, if you want current, just adjust the jumper cap to the C2 position. (Reference ground: GND)	Input voltage range: 0 ~ 10V (input impedance: 100KΩ), input current range: 0 ~ 20mA (input impedance: 500Ω).
	AO	AO provides analog voltage/current output, the current is selected by jumper J2, the factory default output voltage, if you want to output current, just jump the jumper cap to the C position. (Reference ground: GND)	0 ~ 10V DC voltage/0 ~ 20mA current.
Relay output	TA	It can be defined as a multi-function relay output terminal.	TA-TC is NO. Contact rating: 250VAC/2A(COSΦ=1),30VDC/1A.
	TC		
OC output	Y	It can be defined as a multifunctional collector output terminal, which can be used as a high-speed pulse output.	1. Switching capacity: 50mA/30V 2. Output frequency range: 0~50kHz
Power supply	+24V	The common power supply for the circuit of the digital signal input terminal	Maximum output current 200mA
	+10V	The circuit common power supply for analog input and output terminals	Maximum output current 20mA
	OP	The factory default is connected to +24V. When using external signals to drive DI1 ~ DI5, OP needs to be connected to the external power supply and disconnected from the +24V power supply terminal	External power supply input terminal
	GND	Analog signal and +10V power reference ground	Digital GND
Communication	485+	RS485+	Standard RS485 communication interface, not isolated from GND, please use twisted pair or shielded wire. Jumper J8 is for RS485 terminal resistor.
	485-	RS485-	

2.5 Matters needing attention for Wiring

- 1 When replacing the motor, you must cut off the input power of the inverter.
- 2 When the frequency inverter stops outputting, the motor can be switched or the power frequency can be switched.
- 3 In order to minimize the influence of electromagnetic interference, when the electromagnetic contactors and relays used are close to the frequency inverter, the surge absorption device should be considered.
- 4 Do not connect the AC input power to the output terminals U, V and W of the frequency inverter.
- 5 The external control line of the frequency inverter needs to be isolated or shielded.
- 6 In addition to shielding, the input command signal connection should be routed separately, preferably away from the main circuit connection.
- 7 When the carrier frequency is less than 4KHz, the maximum distance between the inverter and the motor should be within 50 meters. When the carrier frequency is greater than 4KHz, this distance should be appropriately reduced. This connection is best laid in a metal pipe.
- 8 When the inverter is equipped with peripheral equipment (filter, reactor, etc.), the insulation resistance to the ground should be measured with a 1000 volt megohmmeter to ensure that it is not lower than 4 megohms.
- 9 Phase-in capacitors or resistance-capacitance absorption devices cannot be installed at the U, V and W output terminals of the frequency inverter.
- 10 If the frequency inverter needs to be started frequently, don't turn off the power supply. You must use the GND/RUN of the control terminal to start and stop, so as not to damage the rectifier bridge.
- 11 In order to prevent accidents, the grounding terminal G must be grounded reliably (the grounding impedance should be below 100Ω), otherwise there will be leakage.
- 12 When wiring the main circuit, please choose the wire diameter specification according to the relevant provisions of the national electrical regulations.

III. Operation and Display

3.1 Operation panel description

3.1.1 Operation panel illustration

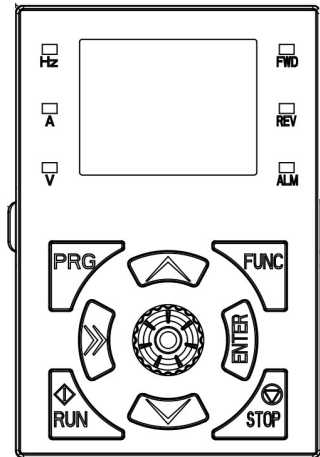

3.1.2 Key Description

Key	Name	Function
PRG	Program key	Enter the menu or exit, parameter modification
ENTER	Confirm key	Enter the menu and confirm the parameter setting
▲	Increment key	Increment of data or function code
▼	Decrement key	Decrement of data or function code
▶▶	Shift key	Select parameter modification bit and display content
RUN	RUN	RUN in keyboard operation mode
STOP/RESET	STOP/RESET	STOP/RESET
FUNC	Multifunctional keys	Switch selection according to function

3.1.3 Function indicator description

Indicator	Function
REV	When the light is on, it indicates reverse operation.
FWD	When the light is on, it indicates forward operation.
ALM	A fast flashing light indicates a fault condition.
Hz	Frequency
A	Current
V	Voltage

3.1.4 Function indicator combination description:

combination	Function	Unit
Hz+A	Motor speed	r/min
A+V	time (s)	s
Hz+V	percentage of actual value	%
Hz+A+V	temperature	°C

3.2 Operating procedures

3.2.1 Parameter settings

The three-level menus are:

1. Function code group number (first-level menu);
2. Function code label (secondary menu);
3. Function code setting value (three-level menu).

Note: When operating in the third-level menu, press PRG or ENTER to return to the second-level menu. The difference between the two is: press ENTER to save the set parameters into the control panel, then return to the secondary menu, and automatically transfer to the next function code; press PRG to directly return to the secondary menu without saving the parameters, and keep at the Current function code.

In the third-level menu state, if the parameter has no blinking bit, it means that the function code cannot be modified. The possible reasons are:

- 1) This function code is an unmodified parameter. Such as actual detection parameters, running record parameters, etc.
- 2) This function code cannot be modified in the running state, and can only be modified after shutdown.

3.2.2 Fault reset

After the inverter fails, the inverter will prompt relevant fault information. The user can reset the fault through the STOP/RESET key on the keyboard or the terminal function. After the fault reset of the inverter, it is in a standby state. If the inverter is in a fault state and the user does not reset the fault, the inverter is in a running protection state and the inverter cannot run.

IV Communication protocol

1. RTU mode and format

When the controller communicates on Modbus in RTU mode, every 8-bit byte in the information is divided into two 4-bit hexadecimal characters. The main advantage of this mode is that the density of characters transmitted by it is higher than that of ASCII mode at the same baud rate, and each information must be continuously transmitted.

(1) The format of each byte in 1)RTU mode

Coding system: 8-bit binary, hexadecimal 0-9, A-F.

Data bit: 1-bit start bit, 8-bit data (lower bit first sent), 1-bit stop bit, and optional parity bit. (Refer to RTU data frame as sequence diagram)

Error check area: cyclic redundancy check (CRC).

(2) RTU data frame bit sequence diagram

With parity check

Start	1	2	3	4	5	6	7	8	Par	Stop
-------	---	---	---	---	---	---	---	---	-----	------

No parity check

Start	1	2	3	4	5	6	7	8	Stop
-------	---	---	---	---	---	---	---	---	------

2. Description of reading and writing function code:

Function code	Functional Description
03	Read register
06	Write register

3. Register address

(2) Register Map	Address
Control command input	2000H
Monitoring parameter reading (D-00 ~ D-30)	1000H~001EH
Communication Frequency setting	2001H
User parameter setting (00.00 ~ 08.06)	0000H~0806H
Factory parameter setting (09.00 ~ 09.10)	0900H~090AH

4. Description of parameter address of communication protocol:

Functional Description	address definition	Explanation of data meaning	R/W
Communication control command	2000H	0001H: Stop	W
		0012H: Forward running	
		0013H: Forward jog operation	
		0022H: Reverse operation	
		0023H: Reverse jog operation	
Communication setting frequency address	2001H	The set frequency range of communication is-10000 ~ 10000. Note: the communication set frequency is a percentage of	W

		the maximum frequency. Its range is-100.00% ~ 100.00%.	
Communication control command	2002H	0001H: external fault input	W
		0002H: fault reset	
Read the stop parameter description of running /	2102H	Set the frequency (two decimal places)	R
	2103H	Output frequency (two decimal places)	R
	2104H	Output current (one decimal place)	R
	2105H	Bus voltage (one decimal place)	R
	2106H	Output voltage (one decimal place)	R
	2107H	Analog input AI (two decimal places)	R
	2108H	Reserved	R
	2109H	Current count value	R
	210AH	Revolving speed of motor	R
	210BH	Analog output AO (two decimal places)	R
	210CH	Reserved	R
	210DH	Inverter temperature (one decimal place)	R
	210EH	PID feedback value (two decimal places)	R
	210FH	PID set value (two decimal places)	R
	2110H	Reserved	R
	2111H	Pulse frequency input	R
	2112H	Current fault	R
	2113H	Current timing value	R
	2114H	Input terminal status	R
	2115H	Output terminal status	R
2116H	BIT0: Run/Stop BIT1: Forward/reverse rotation BIT2: JOG BIT3: DC braking BIT4: Reserved BIT5: Overvoltage limit BIT6: Constant speed frequency reduction BIT7: Overcurrent limit Bit8~9: 00-Zero speed /01- Acceleration /10- Deceleration /11- Uniform speed BIT10: Overload Pre-alarm Bit12~13 Run command channel: 00- Panel /01- Terminal /10- Communication Bit14~15 bus voltage status: 00- normal /01- low voltage protection /10- overvoltage protection	R	

	2101H	Bit0: Operation Bit1: Stop Bit2: JOG Bit3: Forward Bit4: Invert Bit5~ Bit7: Reserved Bit8: Communication given Bit9: Analog signal input Bit10: Communication operation command channel Bit11: Parameter lock Bit12: Running Bit13: With JOG command Bit14~Bit15: Reserved	R
Read the fault code description	2100H	00: No abnormality 01: Module failure 02: Overvoltage 03: Temperature fault 04: Inverter overload 05: Motor overload 06: External fault 07~09: Reserved 10: Overcurrent during acceleration 11: Overcurrent during deceleration 12: Overcurrent in constant speed 13: Reserved 14. Undervoltage 15: Reserved 16: RS485 communication failure 17: Tube burst fault 18: Reserved 19: Dual CPU communication failure 20: Reserved 21: Reserved 22: Current detection fault 23: Reserved 24: Reserved 25: Output out of phase	R

5. 03H Reading function mode:

Inquiry information frame format:

Address	01H
Function	03H
Starting data address	21H
	02H
Data(2Byte)	00H
	02H
CRC CHK Low	6FH
CRC CHK High	07H

Analysis of this data:

- 01H is the inverter address
- 03H is the read function code
- 2102H is the starting address
- 0002H is the number of read addresses, and 2102H and 2103H
- 076FH is a 16-bit CRC validation code

The Response information frame format (return frame)

Address	01H
Function	03H
DataNum*2	04H
Data1[2Byte]	17H
	70H
Data2[2Byte]	00H
	00H
CRC CHK Low	FEH
CRC CHK High	5CH

Analysis of this data:

- 01H is the inverter address
- 03H is the read function code
- 04H is the product of reading item *2
- 1770H reads the data of 2102H (set frequency)
- 0000H is the data of reading 2103H (output frequency)
- 5CFEH is a 16-bit CRC check code

6. 06H write function mode

Inquiry information frame format:

Address	01H
Function	06H
Starting data address	20H
	00H
Data(2Byte)	00H
	01H
CRC CHK Low	43H
CRC CHK High	CAH

Analysis of this data:

- 01H is the inverter address
- 06H is the write function code
- 2000H is the control command address
- 0001H is the stop command
- 43CAH is a 16-bit CRC validation code

The Response information frame format (return frame)

Address	01H
Function	06H
Starting data address	20H
	00H
Number of Data(Byte)	00H
	01H
CRC CHK Low	43H
CRC CHK High	CAH

Analysis of this data: If the settings are correct, return the same input data

V. Exceptions and Handling

See table 4-2 for the common abnormal phenomena and countermeasures of frequency inverter in operation:

Abnormal phenomena		Possible causes and countermeasures
The motor does not rotate	keypad does not display	Check whether there is a power outage, whether the input power supply is out of phase, and whether the input power cable is connected incorrectly
	The keypad is not displayed, but the internal charging indicator is on	Check whether there are problems with the wiring and sockets related to the keypad, and measure the voltage of each control power supply in order to confirm whether the switching power supply works normally. If the switching power supply does not work normally, check whether the inlet (+,-) sockets of the switching power supply are connected well, whether the starting vibration is damaged or whether the voltage stabilizing tube is normal.
	The motor is buzzing	The motor load is too heavy, try to reduce the load
	No abnormalities were found	Check whether it is in tripping state or not reset after tripping, whether it is in power-off restart state, whether the keypad has been reset, whether it has entered program running state, multi-speed running state, specific running state or non-running state, and try to restore the factory value. Confirm whether the operation instruction is given Check whether the operating frequency is set to 0
The motor cannot accelerate and decelerate smoothly		Inappropriate setting of acceleration and deceleration time, increase acceleration and deceleration time
		If the current limiting value is set too small, increase the limiting value
		Over-voltage protection acts during deceleration to increase deceleration time
		Improper setting of carrier frequency, overload or oscillation
		Overload and insufficient torque. Increase torque boost value in V/F mode. If it still cant meet the requirements, you can switch to vector control mode. At this time, pay attention to the fact that the motor parameters should be consistent with the actual values. If it still cant meet the requirements, it is recommended to switch to advanced vector control mode. At this time, you should still pay attention to whether the motor parameters are consistent with the actual values, and it is best to tune the motor parameters.
		The motor power does not match the inverter power. Please set the motor parameters to actual values
		One with more than one motor. Please change the torque lifting mode to manual lifting mode
Although the motor can rotate, it can not adjust the speed		Inappropriate setting of upper and lower frequency limits
		The frequency setting is too low, or the frequency gain setting is too small
		Check whether the speed regulation mode used is consistent with the set frequency
		Check whether the load is too heavy, over-voltage stall or over-current limit
The speed of the motor changes during operation		Load fluctuates frequently, so minimize its variation
		Inverter is seriously inconsistent with motor rating. Please set the motor parameters to actual values
		Poor contact of frequency setting potentiometer or fluctuation of frequency given signal. Change to digital frequency giving mode or increase the filtering time constant of analog input signal
The rotation direction of the motor is opposite		Adjust the phase sequence of output terminals u, v and W.
		Set the running direction (00.12=1) to reverse
		Direction uncertainty caused by output phase failure, please check the motor wiring immediately

Table 4-2 Common Abnormal Phenomena and Countermeasures

VI. Parameters instructions

○- Parameters that can be modified in any state × -Parameters that cannot be modified in the running state ◆-Actual detection parameters, which cannot be modified ◇-Manufacturer parameters, which are only modified by the manufacturer, and users are forbidden to modify them.					
00 groups-basic operating parameters					
Function code	Name	Content	Setting range	Factory setting	Change
00.00	Function macro definition (temporarily reserved)	0: General model 1: Single pump constant pressure water supply mode 2: Reserved 3: Reserved 4: Engraving machine mode 5: Reserved 6: Reserved 7: Reserved 8: Reserved 9: Reserved 10: Reserved	0~10	0	×
00.01	Motor control mode	0: VF control 1: Advanced V/F control 2: Vector control	0~2	0	×
00.02	Run command channel selection	0: Keypad 1: Terminals 2: Communication	0~2	0	○
00.03	Frequency given selection	0: Keypad potentiometer 1: Digital given 1, adjust with ▲ and ▼ keys on the operation panel 2: Digital setting 2, adjust with terminal UP/DOWN 3: AI analog setting (0 ~ 10V/0 ~ 20mA) 4: Combination setting 5: Reserved 6: Communication 7: Reserved Note: When combination given time is selected, the combination given mode is selected in 01.15.	0~7	0	○
00.04	Max output frequency	The maximum output frequency is the highest frequency allowed by the inverter, and it is the benchmark for setting the acceleration and deceleration time.	MAX{50.0,【00.05】}~999.9Hz	50.0Hz	×
00.05	Upper limit frequency	Operating frequency cannot exceed this frequency	MAX{0.1, 【00.06】}~【00.04】	50.0Hz	×
00.06	Lower limit frequency	Operating frequency cannot be lower than this frequency	0.0 ~ upper limit frequency	0.0Hz	×
00.07	Lower limit frequency arrival processing	0: Zero speed operation 1: Running at the lower limit frequency 2: Stop	0~2	0	×
00.08	Digital setting of operating frequency	This set value is the initial value of frequency digital given	0.0 ~ upper limit frequency	10.0Hz	○

00.09	Digital frequency control	LED bits: power-down storage 0: store 1: do not store LED ten-bit: stop hold 0: hold 1: do not keep LED 100-digit: UP/DOWN negative frequency adjustment 0: invalid 1: valid LED thousand bits: frequency superposition selection of PID and PLC 0: invalid 1: 00.03+PID 2: 00.03+PLC	0000~2111	0000	○
00.10	Acceleration time	Time required for inverter to accelerate from 0Hz to maximum output frequency	0.1~999.9S Default: 0.4~4.0KW - 7.5S 5.5~7.5KW - 15.0S	Model setting	○
00.11	Deceleration time	Time required for inverter to decelerate from maximum output frequency to 0Hz			
00.12	Running direction setting	0: forward rotation 1: reverse rotation 2: reverse rotation prohibited	0~2	0	○
00.13	V/F curve setting	0: linear curve 1: Square curve 2: Multi-point VF curve	0~2	0	×
00.14	Torque boost	Manual torque lift. This setting is a percentage relative to the rated voltage of the motor.	0.0~30.0%	Model setting	○
00.15	Torque boost cutoff frequency	This setting is the lifting cut-off frequency point when manual torque is lifted.	0.0~50.0Hz	15.0Hz	×
00.16	Carrier frequency setting	When silent operation is needed, the carrier frequency can be appropriately increased to meet the requirements, but increasing the carrier frequency will increase the calorific value of the inverter.	2.0~16.0KHz 0.4~3.0KW 4.0KHz 4.0~5.5KW 3.0KHz	Model setting	×
00.17	V/F frequency F1		0.1 ~ Frequency value 02	12.5Hz	×
00.18	V/F Voltage V1		0.0 ~ voltage value V2	25.0%	×
00.19	V/F frequency F2		Frequency value 01 ~ frequency value 03	25.0Hz	×
00.20	V/F Voltage V2		Voltage value v1 ~ voltage value V3	50.0%	×
00.21	V/F frequency F3		Frequency value 02 ~ rated frequency of motor 【 04.03】	37.5Hz	×
00.22	V/F Voltage V3		Voltage value v2 ~ 100.0% * uoute (rated voltage of motor [04.00])	75.0%	×
00.23	User password		Set any non-zero number, and wait for 3 minutes or RESTART before it takes effect.	0~9999	0

00.24	Selection of frequency display resolution	0: 0.1Hz 1: 1Hz Note: When setting this parameter, be sure to check the frequency-related parameters such as maximum output frequency (00.04), upper frequency limit (00.05), rated frequency of motor (04.03), etc.	0~1	0	○
01 groups- Auxiliary operating parameters					
Function code	Name	Setting range	Minimum unit	Factory setting	Change
01.00	Starting mode	LED unit: starting mode 0: starting from starting frequency 1: DC braking first and then starting from starting frequency 2: Reserved Ten LED bits: power failure or abnormal restart mode 0: invalid 1: starting from starting frequency LED hundred bits: Reserved LED thousand bits: Reserved	0000~0012	00	×
01.01	Starting frequency		0.0~50.0Hz	1.0Hz	○
01.02	Starting DC braking Voltage		0.0 ~ 50.0% rated Voltage of motor	0.0%	○
01.03	Starting DC braking time		0.0~30.0s	0.0s	○
01.04	Stop mode	0: Deceleration stop 1: Free stop	0~1	0	×
01.05	Start frequency of DC braking during stop		0.0 ~ upper limit frequency	0.0Hz	○
01.06	Stop DC braking Voltage		0.0 ~ 50.0% rated Voltage of motor	0.0%	○
01.07	Time for DC braking during stop		0.0~30.0s	0.0s	×
01.08	Waiting time for DC braking during stop		0.00~99.99s	0.00s	×
01.09	Forward jog frequency		Set the jog FWD and REV rotation frequency	0.0~50.0Hz	10.0Hz
01.10	Reverse jog frequency				
01.11	Jog acceleration time	Setting acceleration and deceleration time of JOG	0.1~999.9S 0.4~4.0KW 10.0S	Model setting	○
01.12	Jog deceleration time		5.5~7.5KW 15.0S		

01.13	Jump frequency	By setting the jumping frequency and range, the frequency inverter can avoid the mechanical resonance point of the load.	0.0 ~ upper limit frequency	0.0Hz	○
01.14	Jump range		0.0~10.0Hz	0.0Hz	○
01.15	Frequency combination given mode	0: Potentiometer+digital frequency 1 1: Potentiometer+digital frequency 2 2: Potentiometer +AI 3: Digital frequency 1+AI 4: Digital frequency 2+AI 5: Digital frequency 1+ multi-speed 6: Digital frequency 2+ multi-speed 7: Potentiometer+Multistage Speed 8: AI+PLC (superposition in the same direction) 9: Reserved	0~9	0	×
01.16	Programmable operation control (simple PLC operation)	LED bit: PLC enable control 0: invalid 1: valid LED ten bits: Operation mode selection 0: single cycle 1: Continuous circulation 2: The final value is maintained after a single loop LED hundred bits: starting mode 0: Restart from the first segment 1: Start from the stage of stop (failure) time 2: Start from the stage and frequency of stop (failure) time LED thousand bits: power-off storage option 0: do not store 1: store	0000~1221	0000	×
01.17	Multi speed frequency 1	Set the segment speed 1 frequency	-upper limit frequency ~ upper limit frequency	5.0Hz	○
01.18	Multi speed frequency 2	Set the segment speed 2 frequency	-upper limit frequency ~ upper limit frequency	10.0Hz	○
01.19	Multi speed frequency 3	Set the segment speed 3 frequency	-upper limit frequency ~ upper limit frequency	15.0Hz	○
01.20	Multi speed frequency 4	Set the segment speed 4 frequency	-upper limit frequency ~ upper limit frequency	20.0Hz	○
01.21	Multi speed frequency 5	Set the segment speed 5 frequency	-upper limit frequency ~ upper limit frequency	25.0Hz	○
01.22	Multi speed frequency 6	Set the segment speed 6 frequency	-upper limit frequency ~ upper limit frequency	37.5Hz	○
01.23	Multi speed frequency 7	Set the segment speed 7 frequency	-upper limit frequency ~ upper limit frequency	50.0Hz	○
01.24	Stage 1 running time	Set the running time of segment speed 1 (the unit is selected by [01.35], and the default is seconds)	0.0~999.9s	10.0s	○
01.25	Stage 2 running time	Set the running time of segment speed 2 (the unit is selected by [01.35], and the default is seconds)	0.0~999.9s	10.0s	○
01.26	Stage 3 running time	Set the running time of segment speed 3 (the unit is selected by [01.35], and the default is seconds)	0.0~999.9s	10.0s	○
01.27	Stage 4 running time	Set the running time of segment speed 4 (the unit is selected by [01.35], and the default is seconds)	0.0~999.9s	10.0s	○
01.28	Stage 5 running time	Set the running time of segment speed 5 (the unit is selected by [01.35], and the default is seconds)	0.0~999.9s	10.0s	○
01.29	Stage 6 running time	Set the running time of segment speed 6 (the unit is selected by [01.35], and the default is seconds)	0.0~999.9s	10.0s	○
01.30	Stage 7 running time	Set the running time of segment speed 7 (the unit is selected by [01.35], and the default is seconds)	0.0~999.9s	10.0s	○

01.31	Stage Select 1 for acceleration and deceleration time	LED bit: Phase 1 acceleration and deceleration time 0~1 LED ten bits: Stage 2 Acceleration and deceleration time 0~1 LED hundred bits: Stage 3 Acceleration and deceleration time 0~1 LED thousand bits: Stage 4 Acceleration and deceleration time 0~1	0000~1111	0000	○
01.32	Stage Select 2 for acceleration and deceleration time	LED bit: Phase 5 acceleration and deceleration time 0~1 LED ten bits: Stage 6 Acceleration and deceleration time 0~1 LED hundred bits: Stage 7 Acceleration and deceleration time 0~1 LED thousand bits: Reserved	000~111	000	○
01.33	Acceleration time 2	Set the acceleration and deceleration time 2	0.1~999.9s 0.4~4.0KW 10.0s 5.5~7.5KW 15.0s	10.0s	○
01.34	Deceleration time 2				
01.35	Time unit selection	LED bit: process PID time unit LED ten bits: simple PLC time unit LED hundred bits: regular acceleration and deceleration time unit LED thousand bits: reserved 0: 1 second 1: 1 minute 2: 0.1 second	000~211	000	×
01.36	Forward and reverse dead zone time	The transition time for the inverter to wait at the 0Hz during the transition from the forward to the reverse operation, or from the reverse operation to the forward.	0.0~999.9s	0.0	○
Group 02-analog and digital input and output parameters					
Function code	Name	Setting range	Minimum unit	Factory setting	Change
02.00	AI input lower limit Voltage	Set AI upper and lower limit voltage	0.00 ~ 【02.01】	0.00V	○
02.01	AI input upper limit Voltage		【02.01】 ~10.00V	10.00V	○
02.02	AI lower limit corresponding setting	Set AI upper and lower limits corresponding to the percentage of the upper limit frequency [00.05].	-100.0% ~ 100.0%	0.0%	○
02.03	AI upper limit corresponding setting			100.0%	○
02.04~02.07	Reserved	Reserved	Reserved	Reserved	○
02.08	The analog input Signal filtering time constant.	This parameter is used to filter the input signals of AI and panel potentiometer to eliminate the influence of interference.	0.1~5.0s	0.1s	○
02.09	Analog input anti-shake deviation limit	When the analog input signal fluctuates frequently near a given value, the frequency fluctuation caused by this fluctuation can be suppressed by setting 02.09.	0.00~0.10V	0.00V	○
02.10	Function Selection of AO terminal	0: Output frequency 1: output current 2: revolving speed of motor 3: Output voltage 4: AI 5: Reserved	0~5	0	○
02.11	AO output lower limit	Set AO output upper and lower limit	0.00~10.00V 0.00~20.00mA	0.00V	○
02.12	AO output upper limit			10.00V	○
02.13	Input terminal DI1 function	0: idle control terminal 1: Forward JOG 2: Reverse JOG 3: Forward (FWD) 4: Reverse (REV) 5: Three-wire operation control	0~30	3	×

02.14	Input terminal DI2 function	6: Free stop control 7: External STOP signal input (STOP) 8: External reset signal input (RST) 9: External fault normally open (NO) input 10: Frequency increment command (UP) 11: frequency decrement command (DOWN)	0~30	4	×
02.15	Input terminal DI3 function	13: Multi-speed selection S1 14: Multistage speed selection S2 15: Multistage speed selection S3 16: Run command channel is forced to terminal 17: Run command channel is forced to communication 18: DC braking Command when stop 19: The frequency command is switched to AI 20: The frequency command is switched to digital frequency 1 21: The frequency command is switched to digital frequency 2	0~30	0	×
02.16	Input terminal DI4 function	22: Reserved 23: Counter clear signal 24: Counter trigger signal 25: Timer reset signal 26: Timing trigger Signal	0~30	0	×
02.17	Input terminal DI5 function	27: Select the acceleration and deceleration time group 28: Pendulum frequency pause (stop at current frequency) 29: Pendulum frequency reset (return to center frequency) 30: external stop/reset signal input (STOP/RST)	0~30	0	×
02.18	FWD/REV terminal control mode	0: Two-wire control mode 1 1: Two-wire control mode 2 2: Three-wire control mode 1 3: Three-wire control mode 2 4: Three-wire control mode 3 5: Reserved	0~5	0	×
02.19	Selection of terminal function detection when power on	0: invalid terminal operation command at power-on 1: valid terminal operation command at power-on.	0~1	0	×
02.20	R output setting	0: Reserved 1: Inverter is ready to run 2: Inverter in running 3: Inverter in zero speed running 4: External fault stop 5: Frequency inverter fault 6: Frequency/speed arrival signal (FAR) 7: Frequency/Speed Level Detection Signal (FDT) 8: The output frequency reaches the upper limit 9: Output frequency reaches lower limit 10: Inverter overload pre-alarm 11: Timer overflow signal	0~17	5	○
02.21	Y Open collector output	12: counter detection signal 13: counter reset signal 14: Auxiliary motor 15: Forward 16: Reverse 17: Output when the frequency arrival to the speed detection level	0~17	0	○
02.22	R close delay	Delay from state change of relay	0.0~255.0s	0.0s	×
02.23	R open delay				
02.24	Frequency reaches FAR detection amplitude	When the output frequency is within the positive and negative detection width of the set frequency, the terminal outputs an effective signal (low level).	0.0Hz~15.0Hz	5.0Hz	○
02.25	FDT1 level setting value		0.0Hz ~ ~ upper limit frequency	10.0Hz	○
02.26	FDT lag value		0.0~30.0Hz	1.0Hz	○

02.27	UP/DOWN terminal modification rate	The function code is the frequency modification rate when setting the UP/DOWN terminal as frequency set , that is, the UP/DOWN terminal is short-circuited with the GND terminal for 1s, and the frequency changes.	0.1Hz~99.9Hz/s	1.0Hz/s	○
02.28	Input terminal pulse trigger mode setting (DI1~DI5)	0: indicates the electrical level trigger mode 1: indicates the pulse trigger mode Note: DI1~DI5 correspond to 1H, 2H, 4H, 8H and 10H in hexadecimal.	0~1FH	0	○
02.29	Input terminal valid logic setting (DI1~DI5)	0: indicates positive logic, that is, the DI terminal is connected to GND and GND is valid, and the disconnection is invalid 1: It means anti-logic, that is, DI terminal is not connected to the GND terminal and GND is invalid, and the disconnection is valid Note: DI1~DI5 correspond to 1H, 2H, 4H, 8H and 10H in hexadecimal.	0~1FH	0	○
02.30	DI1 filter coefficient	Used to set the sensitivity of the input terminal. If the digital input terminal is susceptible to interference and causes misoperation, this parameter can be increased to enhance the anti-interference ability, but the sensitivity of the input terminal will be reduced if the setting is too large. 1: represents 2ms scanning time unit	0~9999	5	○
02.31	DI2 filter coefficient		0~9999	5	○
02.32	DI3 filter coefficient		0~9999	5	○
02.33	DI4 filter coefficient		0~9999	5	○
02.34	DI5 filter coefficient		0~9999	5	○
03 group -PID parameters					
Function code	Name	Setting range	Minimum unit	Factory setting	Change
03.00	PID function setting	LED bit: PID regulation characteristics 0:invalid 1: positive effect When the feedback signal is greater than the given quantity of PID, the output frequency of the inverter is required to decrease (that is, reduce the feedback signal). 2: negative effect When the feedback signal is greater than the given quantity of PID, the output frequency of the inverter is required to rise (that is, reduce the feedback signal). LED ten bits: PID given input channel 0: keypad potentiometer PID given quantity is given by potentiometer on the keypad. 1 Number given PID given quantity is given by numbers and set by function code 03.01. 2 Given pressure (MPa, Kg) Set the given pressure on 03.01 and 03.18. LED hundred digits: PID feedback input channel 0: AI 1: Reserved LED thousand bits: PID sleep selection 0: invalid 1: normal sleep Specific parameters such as 03.10 ~ 03.13 should be set in this method. 2. Disturbed sleeping The parameter setting is the same as when the sleep mode is selected as 0. If the PID feedback value is within the range of the set value of 03.14, the sleep delay time will be maintained and then the disturbance sleep will be entered. When the feedback value is less than the wake-up threshold (PID polarity is positive), wake up immediately.	0000~2122	1010	×
03.01	Given a numerical setting	Use the operation keypad to set the given quantity of PID control. This function is effective only when the PID given channel selects digital given (03.00 ten digits are 1 or 2). If 03.00 digit is 2, it is used as pressure reference, and this parameter is consistent with the unit of 03.18.	0.0~100.0%	0.0%	○
03.02	Feedback channel gain	When the feedback channel is inconsistent with the set channel level, this function can be used to adjust the gain of the feedback channel signal.	0.01~10.00	1.00	○

03.03	Proportional gain P	The speed of PID adjustment is set by two parameters: proportional gain and integration time. For fast adjustment, it is necessary to increase proportional gain and reduce integration time; for slow adjustment, it is necessary to reduce proportional gain and increase integration time. Generally, differential time is no necessary to set	0.01~5.00	2.00	○
03.04	Integration time Ti		0.1~50.0s	1.0s	○
03.05	Derivative time Td		0.1~10.0s	0.0s	○
03.06	Sampling period T	The larger the sampling period, the slower the response, but the better the interference signal suppression effect, so it is generally unnecessary to set it.	0.1~10.0s	0.0s	○
03.07	Deviation limit	The deviation limit is the ratio of the absolute value of the deviation between the feedback amount and the given amount of the system. When the feedback amount is within the deviation limit, the PID adjustment will not act.	0.0~20.0%	0.0%	○
03.08	Closed loop preset frequency	Frequency and running time of inverter before PID is put into operation	0.0 ~ upper limit frequency	0.0Hz	○
03.09	Preset frequency holding time		0.0~999.9s	0.0s	×
03.10	Sleep threshold coefficient	If the actual feedback value is greater than the set value, and the frequency output by the frequency inverter reaches the lower limit frequency, the frequency inverter will enter the sleep state after the delay waiting time defined in 03.12 (i.e., running at zero speed); The value is a percentage of the PID set value.	0.0~150.0%	100.0%	○
03.11	Awakening threshold coefficient	If the actual feedback value is less than the set value, the frequency inverter will get out of sleep and start working after the delay waiting time defined in 03.13; The value is a percentage of the PID set value.	0.0~150.0%	90.0%	○
03.12	Sleep delay time	Set up Sleep delay time	0.0~999.9s	100.0s	○
03.13	Wake delay time	Set up Wake delay time	0.0~999.9s	1.0s	○
03.14	Deviation between feedback and set pressure when entering sleep	This function parameter is only valid for disturbance sleep mode	0.0~10.0%	0.5%	○
03.15	Delay time of burst detection	Set the burst tube detection delay time	0.0~130.0s	0.0S	○
03.16	High pressure detection threshold	When the feedback pressure is greater than or equal to this set value, the explosion failure "EPA0" will be reported after the explosion delay at 03.15, and when the feedback pressure is less than this set value, the explosion failure "EPA0" will automatically reset; The threshold is a percentage of the given pressure.	0.0~200.0%	150.0%	○
03.17	Low pressure detection threshold	When the feedback pressure is less than this set value, the explosion failure "EPA0" will be reported after the explosion delay at 03.15, and when the feedback pressure is greater than or equal to this set value, the explosion failure "EPA0" will automatically reset; The threshold is a percentage of the given pressure.	0.0~200.0%	50.0%	○
03.18	Measurement range of sensors	Set the maximum range of the sensor	0.00~99.99 (MPa、Kg)	10.00MPa	○
04 group -advanced functions parameters					
Function code	Name	Setting range	Minimum unit	Factory setting	Change
04.00	Motor rated voltage	Setting of motor parameters	0~500V: 380V 0~250V: 220V	Model setting	×
04.01	Motor rated current		0.1~999.9A	Model setting	×
04.02	Motor rated speed		0~9999RPM	Model setting	×
04.03	Motor rated frequency		1.0~999.9Hz	50.0Hz	×
04.04	Motor stator resistance	Set the motor stator resistance	0.001~20.000Ω	Model setting	○
04.05	Motor no-load current	Set the motor no-load current	0.1~ 【04.01】	Model setting	×

04.06	AVR function	0: invalid 1: the whole process is effective 2: invalid only when decelerating	0~2	0	×
04.07	Cooling fan control	0: Automatic control mode 1: runs all the time during power on	0~1	0	○
04.08	Automatic fault reset times	When the number of fault resets is set to 0, there is no automatic reset function, and it can only be reset manually. When it is set to 10, the number of times is unlimited, that is, countless times.	0~10	0	×
04.09	Automatic fault reset interval	Set the automatic fault reset interval	0.5~25.0s	3.0s	×
04.10	Energy consumption braking starting voltage	If the internal DC bus voltage of the frequency inverter is higher than the starting voltage of energy consumption braking, the built-in braking unit will act. If a braking resistor is connected at this time, the voltage energy raised inside the frequency inverter will be released through the braking resistor, and the DC voltage will fall down.	330~380/660~800V	350/780V	○
04.11	Energy consumption braking action ratio		10~100%	100%	○
04.12	Over modulation function selection	0: invalid 1: valid	0~1	0	×
04.13	PWM mode	0: full frequency seven segments 1: full frequency five segments 2: seven segments to five segments 3. Single-phase asynchronous motor mode	0~3	0	×
04.14	Slip compensation coefficient	The speed of asynchronous motor will decrease after being loaded. Slip compensation can make the speed of motor close to its synchronous speed, thus making the speed control accuracy of motor higher. This coefficient is only valid for ordinary V/F mode.	0~200%	100%	×
04.15	Slip compensation mode	0: invalid 1: low frequency compensation Note: This parameter is only valid for advanced V/F.	0~1	0	×
04.16	Self-learning of motor parameters	0: invalid 1: Static self-learning (STAR is displayed immediately when it is started. After finished, END is displayed and disappears after 1s	0~1	0	×
04.17	Motor rated Power	After the rated power of the motor is changed to 04.17, 04.01, 04.02, 04.04, 04.05, 04.18 ~ 04.20 are automatically updated as the default parameters of the motor with corresponding power.	0.0~2000.0KW	Model setting	○
04.18	Rotor resistance of motor		0.00~200.00Ω	Model setting	○
04.19	Inductance of stator and rotor of motor		0.00~200.00mH	Model setting	○
04.20	Mutual inductance between stator and rotor of motor		0.00~200.00mH	Model setting	○
04.21	Speed loop 1 Proportional gain	Function codes 04.21 ~ 04.26 are valid in vector control mode. By setting proportional gain P and integration time I, the speed response characteristics of vector control are changed.	1~100	30	×
04.22	Speed loop 1 Integral time		0.01~10.00S	0.50	○
04.23	Low frequency switching point		0.0~10.0Hz	5.0	×
04.24	Speed loop 2 Proportional gain		1~100	20	○
04.25	Speed loop 2 Integral time		0.01~10.00S	1.00	○
04.26	High frequency switching point		【04.23】~320.0Hz	10.0	×
04.27	Vector Slip compensation	In vector control mode, this parameter is used to adjust the speed stability accuracy of the motor. When the motor is overloaded and the speed is low, increase this parameter, otherwise decrease this parameter.	50% ~ 200%	100	○
04.28	speed loop filter time constant	Set the speed loop filtering time	0.000~1.000S	0.010	○
04.29	Reserved	-	-	0	◆
04.30	speed loop torque limit	The set value is a percentage of the rated current of the motor	0.0% ~ 200.0%	150.0	○

05 Group- Protective Function parameters					
Function code	Name	Setting range	Minimum unit	Factory setting	Change
05.00	Protection settings	LED unit: motor overload protection option 0: invalid 1: valid LED Ten bits: PID feedback disconnection protection 0: invalid 1: protection action and free stop LED hundred bits: 485 communication failure handling 0: protection action and free stop 1: alarm but maintain the status operation; 2: alarm and stop in the set way LED thousand bits: Oscillation Suppression 0: invalid 1: valid	0000~1211	0001	×
05.01	Motor overload protection coefficient	The motor overload protection coefficient is the percentage of the rated current value of the motor to the rated output current value of the inverter.	30% ~ 110%	100%	×
05.02	Undervoltage protection level	This function code specifies the allowable lower limit voltage of DC bus when the inverter works normally.	50~280/50~480V	180/360V	×
05.03	Voltage limiting factor during deceleration	This parameter is used to adjust the ability of the inverter to suppress overvoltage during deceleration.	0: off, 1 ~ 255	1	×
05.04	Overvoltage limit level	Overvoltage limit level defines the operating voltage during overvoltage stall protection	350~400/660~850V	375/700V	×
05.05	Current limiting coefficient during acceleration	This parameter is used to adjust the ability of inverter to restrain overcurrent during acceleration.	0: off, 1 ~ 99	10	×
05.06	Current limiting coefficient during constant speed	This parameter is used to adjust the ability of inverter to restrain overcurrent in the process of constant speed.	0: off, 1 ~ 10	0	×
05.07	Current limiting level	The current limiting level defines the current threshold of automatic current limiting operation, and its set value is the percentage relative to the rated current of the inverter.	50% ~ 200%	160%	×
05.08	Feedback disconnection detection value	This value is the percentage of PID given quantity. When the feedback value of PID is continuously less than the feedback disconnection detection value, the inverter will make corresponding protection actions according to the setting of 05.00, and it will be invalid when 05.08=0.0%.	0.0~100.0%	0.0%	×
05.09	Feedback disconnection detection time	Delay time before protection action after feedback disconnection.	0.1~999.9S	10.0s	×
05.10	Inverter Overload pre-alarm level	The current threshold for the overload warning action of the inverter. The set value is a percentage of the rated current of the inverter.	0~150%	120%	○
05.11	Inverter Overload pre-alarm delay	The delay time between the output current of inverter continuously exceeding the horizontal amplitude of overload pre-alarm (05.10) and the output of overload pre-alarm signal.	0.0~15.0s	5.0s	×
05.12	JOG priority enable	0: invalid 1: when the inverter is running, the jog priority is the highest	0~1	0	×
05.13	Oscillation suppression coefficient	In case of motor oscillation, it is necessary to set the effective value of 05.00 thousand bits, turn on the oscillation suppression function, and then adjust it by setting the oscillation suppression coefficient. In general, the oscillation amplitude is large, so it is unnecessary to set the oscillation suppression coefficient of 05.13, 05.14 ~ 05.16; In case of special occasions, they should be used together from 05.13~05.16.	0~200	30	○
05.14	Amplitude suppression coefficient		0~12	5	○
05.15	The Lower limit frequency of oscillation suppression		0.0~【05.16】	5.0Hz	○
05.16	The upper limit frequency of oscillation suppression		【05.15】~【00.05】	45.0Hz	○

05.17	Selection of wave-by-wave current limit	LED bit: In acceleration 0: invalid 1: valid LED ten bits: In deceleration 0: invalid 1: valid LED hundred-bits: In constant speed 0: invalid 1: valid LED Thousand bits:Reserved	000~111	011	×
05.18	Output phase lost protection detection coefficient	When the ratio of the maximum value to the minimum value in the three-phase output current is greater than this coefficient and the duration exceeds 6 seconds, the frequency inverter reports the output current imbalance fault EPLI; ; Output open-phase protection is invalid when 05.18=0.00.	0.00~20.00	2.00	○
05.19	Frequency drop coefficient of instantaneous power failure	Set the instantaneous power-down frequency drop factor	0: the instantaneous stop function is invalid 1~9999	0	○
05.20	Instantaneous power down loss frequency reduction voltage point	Instantaneous power down loss frequency reduction voltage point	220V:180~330V 250V 380V:300~550V 450V	Model setting	×
06 group: communication parameters					
Function code	Name	Setting range	Minimum unit	Factory setting	Change
06.00	Local Address	Set the local address, 0 is the broadcast address.	0~247	1	×
06.01	MODBUS communication configuration	LED bit: baud rate selection 0: 9600BPS 1: 19200BPS 2: 38400BPS LED ten bits: data format 0: no parity 1: even parity check 2: Odd Parity Check LED hundred bits:Communication response mode 0: normal response 1: Only respond to the slave address 2: no response 3: The slave machine does not respond to the free stop instruction of the host machine in broadcast mode LED thousand bits:Reserved	0000~0322	0000	×
06.02	communication timeout check-out time	If the machine does not receive the correct data signal within the time interval defined by this function code, then the machine thinks that the communication has failed, and the frequency inverter will decide whether to protect or maintain the current operation according to the setting of the communication failure action mode; When this value is set to 0.0, RS485 communication timeout detection is not performed.	0.1~100.0s	10.0s	×
06.03	local machine response delay time	This function code defines the intermediate time interval between receiving the data frame of the inverter and sending the response data frame to the upper computer. If the response time is less than the system processing time, the system processing time shall prevail.	0~200ms	5ms	×
06.04	Proportional linkage coefficient	This function code is used to set the weight coefficient of frequency instruction received by inverter as slave through RS485 interface, and the actual operating frequency of this machine is equal to the value of this function code multiplied by the value of frequency setting instruction received through RS485 interface. In the linkage control, this function code can set the ratio of operating frequency of multiple inverters.	0.01~10.00	1.00	○
06.05	(reserved)	Reserved	0~3	0	×

07 Group- supplementary Function parameters					
Function code	Name	Setting range	Minimum unit	Factory setting	Change
07.00	Counting and timing mode	LED bit: count arrival processing 0: One-cycle counting, stop output 1: One-cycle counting, continue to output 2: Cycle counting, stop output 3: Cycle counting, continue to output LED ten bits: Reserved LED hundred bits: timing arrival processing 0: One-cycle counting, stop output 1: One-cycle counting, continue to output 2: Cycle counting, stop output 3: Cycle counting, continue to output LED thousand bits: reserved	000~303	103	×
07.01	The counter reset value setting	Set the counter reset value	【07.02】~9999	1	○
07.02	Setting of counter detection value	Set the counter detection value	0~【07.01】	1	○
07.03	Timing setting	Set the timing time	0~9999s	0s	○
07.04~07.07	Reserved	-	-	0	○
07.08	Swing frequency control	0: prohibited 1: valid	0~1	0	×
07.09	Swing frequency control	0: fixed swing The reference value of swing is the maximum output frequency (00.04). 1: variable swing The reference value of the swing is the given channel frequency.	0~1	0	×
07.10	Swing frequency stop starting mode selection	0: start according to the state memorized before stop 1: restart starting	0~1	0	×
07.11	Swing frequency amplitude	The swing frequency amplitude is a percentage of the maximum output frequency (00.04).	0.0~100.0%	0.0%	○
07.12	Jump frequency	This function code refers to the amplitude of rapid decline after the frequency reaches the upper limit frequency of the swing frequency, and of course it also refers to the amplitude of rapid rise after the frequency reaches the lower limit frequency of the swing frequency. This value is a percentage relative to the swing frequency amplitude (07.11). If it is set to 0.0%, there will be no sudden jump frequency.	0.0~50.0%	0.0%	○
07.13	Swing frequency rise time	Running time from the lower frequency of the swing frequency to the upper frequency of the swing frequency.	0.1~3600.0s	5.0	○
07.14	Pendulum frequency falling time	The running time from the upper swing frequency to the lower swing frequency.	0.1~3600.0s	5.0	○
07.15	Frequency delay of swing frequency upper limit	Set the upper and lower frequency delays of pendulum frequency.	0.1~3600.0s	5.0	○
07.16	Frequency delay of swing frequency lower limit		0.1~3600.0s	5.0	○
Group 08-manage and display parameters					
Function code	Name	Setting range	Minimum unit	Factory setting	Change
08.00	Main parameter monitoring during operation	For example: 08.00=2, that is, select the output voltage (D-02), then the default display item on the main monitoring interface is the current output voltage value.	0~30	0	○
08.01	Main parameter monitoring during stop	For example: 08.01=3, that is, bus voltage (d-03) is selected, then the default display item of the main monitoring interface is the current bus voltage value.	0~30	1	○
08.02	Auxiliary parameter display during operation (only valid for dual display keypad)	For example: 08.02=4, that is, select the output Current (D-02), then the default display item on the main monitoring interface is the current output voltage value.	0~30	4	○
08.03	Auxiliary parameter display during stop (only valid for dual display keypad)	For example: 08.03=3, that is, bus voltage (d-03) is selected, then the default display item of the main monitoring interface is the current bus voltage value.	0~30	3	○

08.04	Motor speed display coefficient	It is used to correct the display error of speed scale, and has no influence on the actual speed.	0.01~99.99	1.00	○
08.05	Initialization of the parameter	0: No-operation The inverter is in normal parameter reading and writing state. Set value of function code Whether it can be changed depends on the setting state of the user password and the current working state of the inverter. 1: Restore the factory settings All user parameters are restored to the factory settings according to the model. 2: Clear fault record Clear the contents of fault records (d-19~d-24). After the operation is completed, this function code is cleared to 0 automatically.	0~2	0	×
08.06	FUNC key settings	0:JOG 1: FWD and REV switch 2: clear ▲/▼ key frequency setting 3: REV (at this time, the RUN key defaults to FWD)	0~3	0	×
Group d-monitoring parameter group					
Function code	Name	Range	Minimum unit	Factory setting	Change
d-00	Output frequency(Hz)	0.0~999.9Hz	0.1Hz	0.0Hz	◆
d-01	Set frequency(Hz)	0.0~999.9Hz	0.1Hz	0.0Hz	◆
d-02	Output voltage(V)	0~999V	1V	0V	◆
d-03	DC Bus voltage(V)	0~999V	1V	0V	◆
d-04	Output current(A)	0.0~999.9A	0.1A	0.0A	◆
d-05	Motor speed (rpm)	0~6000rpm	1rpm	Model setting	◆
d-06	Analog input AI1(V/mA)	0.00~10.00V/0.00~20.00mA	0.01V/0.01mA	0.00V/mA	◆
d-07	Reserved	-	0	0	◆
d-08	Analog input AO(V/mA)	0.00~10.00V/0.00~20.00mA	0.01V/0.01mA	0.00V/mA	◆
d-09	Reserved	-	-	0	◆
d-10	PID pressure setting value	0.00~10.00V/0.00~99.99(MPa、Kg)	0.01V/(MPa、Kg)	0.00V/(MPa、Kg)	◆
d-11	PID pressure feedback value	0.00~10.00V/0.00~99.99(MPa、Kg)	0.01V/(MPa、Kg)	0.00V/(MPa、Kg)	◆
d-12	Current count value	0~9999s	1s	0s	◆
d-13	Current timing value (s)	0~9999s	1s	0s	◆
d-14	Input terminal status(DI1-DI5)	0~1FH	1H	0H	◆
d-15	Output status (Y/R)	0~3H	1H	0H	◆
d-16	Module temperature (°C)	0.0~132.3°C	0.1°C	0.0	◆
d-17	Software upgrade date (year)	2010~2026	1	2021	◆
d-18	Software Upgrade Date (Month Day)	0~1231	1	0615	◆
d-19	Secondary fault code	0~19	1	0	◆
d-20	The last fault code	0~19	1	0	◆
d-21	Output frequency in the last fault (Hz)	0.0~999.9Hz	0.1Hz	0.0Hz	◆
d-22	Output current during the last fault (a)	0.0~999.9A	0.1A	0.0V	◆
d-23	Bus voltage at the last fault (v)	0~999V	1V	0V	◆

d-24	Module temperature during the last fault (°C)	0.0~132.3°C	0.1°C	0.0°C	◆
d-25	Accumulated operation time of frequency inverter (h)	0~9999h	1h	0h	◆
d-26	Inverter state	0~FFFFH BIT0: Run/Stop BIT1: REV/FWD BIT2: JOG BIT3: DC braking BIT4: reserved BIT5: overvoltage limit BIT6: Constant speed frequency reduction BIT7: overcurrent limit Bit8~9: 00- Zero speed 01- Acceleration 10- Deceleration 11- Uniform speed BIT10: Overload Pre-alarm BIT11: Reserved Bit12~13 Run command channel: 00- Panel 01- Terminal 10- Reserved Bit14~15: DC bus voltage status: 00- normal 01- low voltage protection 10- overvoltage protection	1H	0H	◆
d-27	Software version	1.00~99.99	0.01	2.00	◆
d-28	Power model	0.10~99.9KW	0.01KW	Model setting	◆
d-29	Estimated frequency of motor	0.0 ~ maximum output frequency [00.04] Note: the running frequency of the motor calculated from the estimated speed of the motor	0.1Hz	0.0Hz	◆
d-30	Output torque	-200~+200%	1%	0%	◆

Group e-fault code

Fault code	Name	Possible reason of fault	Fault countermeasures	Code
E0C1	Overcurrent in acceleration	Acceleration time is too short	Extended the acceleration time	1
		Low inverter power	Choose a frequency inverter with high power level	
		Improper setting of V/F curve or torque boost	Adjust V/F curve or torque lift	
E0C2	Overcurrent in deceleration	Deceleration time is too short	Extended deceleration time	2
		Low inverter power	Choose a frequency inverter with high power level	
E0C3	Overcurrent in uniform operation	Low grid voltage	Check the input power supply	3
		The load is mutated or abnormal	Check the load or reduce the load mutation	
		Low inverter power	Choose a frequency inverter with high power level	
EHU1	Overvoltage during acceleration	Input voltage abnormal	Check the input power supply	4
		Restart the rotating motor	Set to start after DC braking	
EHU2	Overvoltage during deceleration	Deceleration time is too short	Extended deceleration time	5
		Input voltage abnormal	Check the input power supply	
EHU3	Overvoltage in uniform operation	Input voltage abnormal	Check the input power supply	6
EHU4	overvoltage during stop	Input voltage abnormal	Check the power supply voltage	7
ELU0	Undervoltage during operation	Input voltage is abnormal or relay is not pulled in	Check the power supply voltage or ask the manufacturer for service	8

ESC1	Power module failure	Inverter output short circuit or grounding	Check the motor wiring	9
		Instantaneous overcurrent of frequency inverter	See overcurrent countermeasures	
		Abnormal control panel or serious interference	Seek services from manufacturers	
		Power device damage	Seek services from manufacturers	
E-OH	Overheating radiator	Ambient temperature is too high	Lower ambient temperatures	10
		Fan damaged	Replace the fan	
		Clogged air duct	Clear the air duct	
EOL1	Inverter overload	Improper setting of V/F curve or torque boost	Adjust V/F curve or torque lift	11
		Grid voltage is too low	Check the grid voltage	
		Acceleration time is too short	Extended the acceleration time	
		The motor is overloaded	Choose a frequency inverter with higher power	
EOL2	Motor overload	Improper setting of V/F curve or torque boost	Adjust V/F curve or torque lift	12
		Grid voltage is too low	Check the grid voltage	
		The motor is locked or the load mutation is too large	Check the load	
		Motor overload protection factor is not set correctly	correctly set Motor overload protection coefficient	
E-EF	External equipment fault	External equipment fault input terminal closed	Disconnect External Equipment Fault Input Terminal and Clear Fault	13
EPOF	Dual CPU communication failure	CPU communication failure	Seek services from manufacturers	14
EPID	PID feedback disconnection	Loose PID feedback circuit	Check the feedback connection	15
		The feedback amount is less than the disconnection detection value	Adjust the detection input threshold	
E485	RS485 communication failure	Does not match the baud rate of the upper computer	Adjust baud rate	16
		RS485 channel interference	Check whether the communication connection is shielded and the wiring is reasonable. If necessary, consider connecting the filter capacitor in parallel	
		Communication timeout	Retry	
ETUN	Motor tuning fault	Incorrect setting of motor parameters	Reset the motor parameters	17
ECCF	Current detection fault	Fault of current sampling circuit	Seek services from manufacturers	18
		Auxiliary power failure		
EEEP	EEPROM reading and writing error	EEPROM fault	Seek services from manufacturers	19
EPLI	Output phase loss protection	Output U, V and W are out of phase	Check the output wiring	20
EPAO	Tube bursting fault	The feedback pressure is less than the low pressure detection threshold or greater than or equal to the high pressure detection threshold	Check the feedback connection or adjust the high and low pressure threshold	22

VII. Parameter description

00 groups-basic operating parameters

00.00	Function macro definition (temporarily reserved)	
	0~10	0

0: General model

1: Single pump constant pressure water supply mode

2: Reserved

3: Reserved

4: Engraving machine mode

5~10: Reserved

Note: Initialize the parameters first, and then set the macro function.

00.01	Motor control mode	
	0~2	-

0: Normal V/F control

When it is necessary to use a single inverter to drive more than one motor, the control method used when the motor parameter self-learning cannot be performed correctly or the controlled motor parameters cannot be obtained through other ways. This control method is the most commonly used motor control method. This control method can be used in any occasion that does not require high motor control performance.

1: Advanced V/F control

This control mode introduces the idea of magnetic flux closed-loop control, which can greatly improve the torque response of motor control in the full frequency range, and enhance the torque output capability of the motor at low frequency. At the same time, it is not too sensitive to motor parameters like the field-oriented vector control. This control mode is especially suitable for some occasions that have certain requirements for starting torque (such as wire drawing machines, ball mills, etc.).

2: Vector control (sensitivity of motor parameters)

A true vector control method. In addition to the high torque output performance of the magnetic flux control method, this control method also has the effect of flexible torque output. It can be described as both rigid and flexible, but this control method is more sensitive to motor parameters. Use it after enabling the self-learning of motor parameters, otherwise the effect will be poor.

00.02	Run command channel selection	
	0~2	0

This function code selects the physical channel where the inverter accepts operation commands such as running and stopping.

0: The operation panel runs the command channel

Operation control is implemented by the, (RUN), (STOP/RESET), (M-FUNC) and other keys on the operation panel.

1: Terminal operation command channel

Operation control is implemented by multi-function terminals defined as FWD, REV, JOG forward rotation, JOG reverse rotation and other functions.

2: Communication operation command channel

Operation control is implemented by the upper controller through communication.

00.03	Main frequency source A selection	
	0~7	0

0: Panel potentiometer setting

The operating frequency is adjusted by operating the potentiometer on the keyboard, and the range of the potentiometer's adjustment frequency is fixed from 0 to the maximum output frequency [00.04].

1: Digital setting 1, panel 

The initial value of the frequency setting is 00.08, which can be adjusted with the operation panel keys  or digital encoder. The modified frequency value will be stored in 00.08 after power failure (if you want this frequency not to be stored, you can set 00.09 bits to 1 to achieve).

2: Digital setting 2, UP/DOWN terminal adjustment

The initial value of the frequency setting is 00.9, and the operating frequency is changed by the on/off of the multi-function terminal defined externally as the UP/DOWN function (see the function number of the frequency increment and decrement item of the DI terminal in group 02 for details), when the UP terminal and the GND terminal are closed, The frequency rises; when the DOWN terminal is closed with the GND terminal, the frequency drops; when the UP/DOWN terminal is closed or disconnected with the GND terminal at the same time, the frequency remains unchanged. If you set the frequency to be stored when power off, the modified frequency value will be stored in 00.9 after power off. The rate at which the UP/DOWN terminal modifies the operating frequency can be set by function code 02.27.

3: AI analog setting (0~10V/20mA)

The frequency setting is determined by the AI terminal analog voltage/current, the input range:

For DC 0~10V/20mA related settings, see the definition of function 02.00~02.03.

4: Combination given

When the combination is given, the combination setting mode is selected in 01.15.

5: reserved

6: Communication settings

Change the set frequency through the serial port frequency setting command. For details, see Group 06 communication parameters.

7: Reserved

00.04	Maximum output frequency	
	MAX { 50.0, 【00.05】 } ~ 999.9Hz	50.00
00.05	Upper limit frequency	
	MAX{0.1Hz, 【00.06】 }~ 【00.04】	50.00
00.06	Lower limit frequency	
	0.0Hz~ 【00.05】	0.00

The maximum output frequency is the highest frequency that the inverter allows to output, and is the basis for the acceleration and deceleration time setting, as shown in the following figure, f_{max} ;

The basic operating frequency is the minimum frequency when the inverter outputs the highest voltage, generally the rated frequency of the motor, as shown in the following figure f_b ; the maximum output voltage V_{max} is the corresponding output voltage when the inverter outputs the basic operating frequency, generally the motor rated voltage; V_{max} as shown in the figure below; f_H and f_L are respectively defined as the upper limit frequency and the lower limit frequency, as shown in Fig. 00-1:

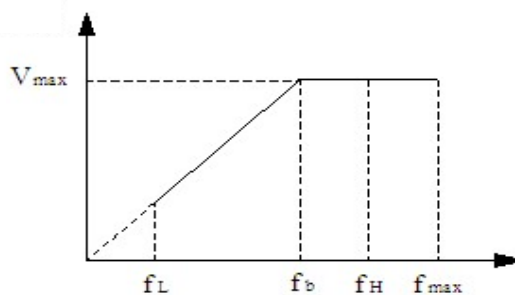

Fig. 00-1 Schematic diagram of voltage and frequency

00.07	Action when the set frequency is lower than the lower limit frequency	
	0~2	0

0: Zero speed operation

When the set frequency is lower than the lower limit frequency set value (00.06), the inverter runs at zero speed.

1: Run at the lower frequency limit

When the set frequency is lower than the lower limit frequency setting value (00.06), the inverter will run at the lower limit frequency.

2: After the shutdown

When the set frequency is lower than the lower limit frequency set value (00.06), the inverter will stop.

00.08	Digital setting of operating frequency	
	0.00Hz~【00.05】	50.00

When the frequency channel is defined as digital reference, this function parameter is the digital frequency reference of the inverter panel and the initial setting frequency of UP/DOWN.

00.09	Digital frequency setting 1 control	
	0000~2111	0000

LED units: power-down storage

0: store

When the inverter is powered on, the panel frequency increment is initialized to the value saved in the EEPROM at the last power-off.

1: Do not store

When the inverter is powered on, the panel frequency increment is initialized to 0.

LED ten digits: stop keeping

0: keep on stop

When the inverter stops, the frequency setting value is the final modified value.

1: Do not keep

When the inverter stops, the set frequency is restored to 00.08.

Hundreds of LEDs:  Negative frequency adjustment

0: invalid

1: Effective

When the selection is valid, operating the keyboard keys  can realize the positive and negative adjustment of the frequency.

Thousands of LED: PID, PLC frequency superposition selection

0: invalid

1:00.03+PID

The main frequency given channel and PID frequency are added together as the final given frequency of the inverter.

2:00.03+PLC

The main frequency given channel is added to the PLC frequency as the final given frequency of the inverter.

00.10	Acceleration time	
	0.1~999.9S	Model setting
00.11	Deceleration time	
	0.1~999.9S	Model setting

The acceleration time refers to the time required for the inverter to accelerate from zero frequency to the maximum output frequency, as shown in t1 in the figure below. Deceleration time refers to the time required for the inverter to decelerate from the maximum output frequency to zero frequency, as shown in t2 in the figure below.

There are two sets of acceleration and deceleration time parameters for this series of inverters. The acceleration and deceleration time of the other group is defined in the function code 01.33~01.34. The factory default acceleration and deceleration time is determined by the model. If you want to select other acceleration and deceleration time groups, Please select through the multi-function terminal (please refer to the function code 02.13~02.17). The acceleration and deceleration time during jog operation are defined separately in 01.11 and 01.12.

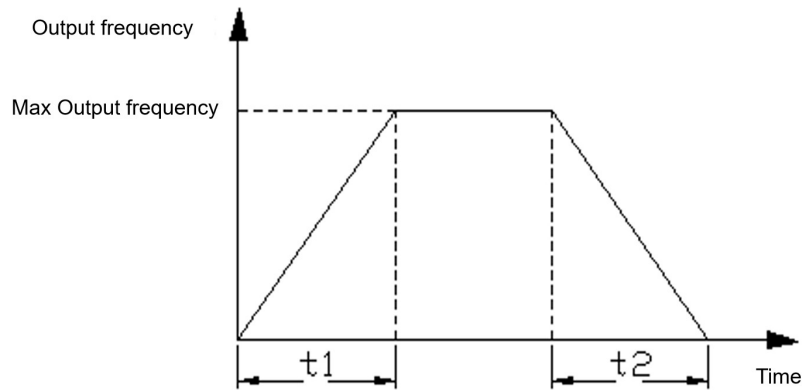

Figure 00-2 Schematic diagram of acceleration time and deceleration time

00.12	Rotation direction setting	
	0~2	0

0: forward

When this mode is selected, the actual output phase sequence of the inverter is consistent with the system default phase sequence. At this time, the functions of the keys on the panel and the FWD terminal become forward rotation control.

1: Reverse

When this mode is selected, the actual output phase sequence of the inverter will be opposite to the system default phase sequence. At this time, the functions of the keys on the panel and the FWD terminal become reverse control.

2: Reversal is prohibited

In any case, the motor can only run forward. This function is suitable for occasions where reverse operation may bring danger or property damage. Given a reverse command, the inverter runs at zero speed.

00.13	V/F curve setting	
	0~2	0

This group of function codes defines the setting mode of the motor's V/F curve to meet the requirements of different load characteristics. According to the definition of 00.13, fixed curves and a custom curve can be selected.

0: linear curve

The linear curve is suitable for ordinary constant torque load, and the output voltage has a linear relationship with the output frequency.

1: Square curve

The square curve is suitable for square torque loads such as fans and water pumps to achieve the best energy saving effect. The output voltage and the output frequency have a square curve relationship.

2: Multi-point V/F curve (determined by 00.17~00.22)

When 00.13 selects 2, the user can customize the V/F curve through 00.17~00.22, and define the V/F curve by adding (V1, 01), (V2, F2), (V3, F3), and the origin and maximum frequency points. F curve is suitable for special load characteristics.

00.14	Torque boost setting	
	0.0~30.0% Motor rated voltage	Model setting
00.15	Torque boost cut-off frequency	
	0.0~50Hz	15.00

In order to compensate for the low-frequency torque characteristics, some boost compensation can be made to the output voltage. When this function code is set to 0.0%, it is automatic torque boost. When it is set to any value other than 0.0%, it is manual torque boost mode. 00.15 defines the boost cut-off frequency point f_z during manual torque boost, as shown in Figure 00 -4 shown.

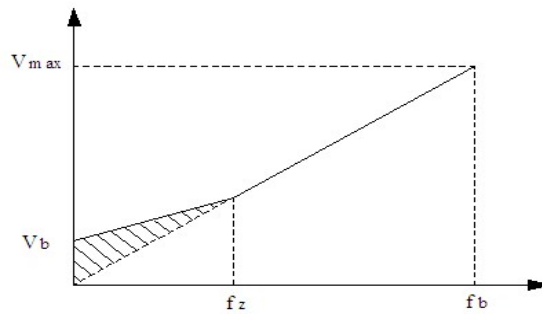

Vb-Manual torque boost

Figure 00-4 Schematic diagram of torque boost

⚠ Notice:

- 1: In the normal V/F control mode, the automatic torque boost mode is invalid.
- 2: Automatic torque boost is only valid in advanced V/F control mode.

00.16	Carrier frequency setting		
	1.0~16.0KHz		Model setting
0.4~2.2KW	4.0KHz	1.0~16.0KHz	
4.0~5.5KW	3.0KHz	1.0~16.0KHz	

This function code is used to set the carrier frequency of the PWM wave output by the inverter. The carrier frequency will affect the noise when the motor is running. For occasions that require silent operation, the carrier frequency can be appropriately increased to meet the requirements. However, increasing the carrier frequency will increase the heat generation of the inverter and at the same time increase the electromagnetic interference to the outside world.

When the carrier frequency exceeds the factory setting value, the inverter needs to be derated for use. Generally, the inverter current needs to be derated by about 5% for every 1KHz increase in the download wave.

00.17	V/F Frequency value F1	
	0.00~Frequency value F2	12.5 Hz
00.18	V/F Voltage value V1	
	0.0~Voltage value V2	25.0%
00.19	V/F Frequency value F2	
	Frequency value F1~Frequency value F3	25.0 Hz
00.20	V/F Voltage value V2	
	Voltage value V1~Voltage value V3	50.0%
00.21	V/F Frequency value F3	
	Frequency value F2~Motor rated frequency 【04.03】	37.5 Hz
00.22	V/F Voltage value V3	
	Voltage value V2~100.0%*motor rated voltage 【04.00】	75.0%

The schematic diagram of voltage and frequency is as follows:

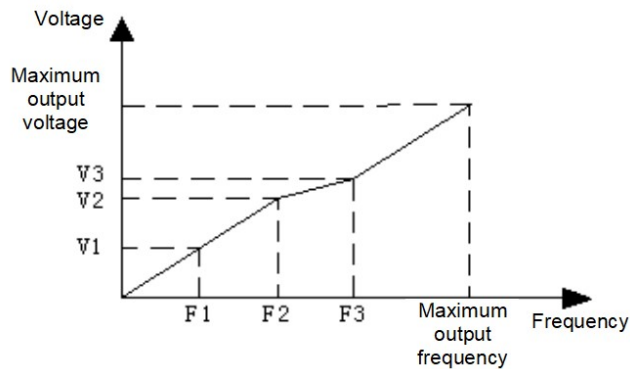

Figure 00-5 Schematic diagram of user setting V/F curve

00.23	User password	
	0~9999	0

The user password setting function is used to prohibit unauthorized personnel from viewing and modifying function parameters.

When setting the user password, enter any non-zero number, press the key to confirm, and the password will automatically take effect after 3 minutes.

When you need to change the password, select the 00.23 function code and press the key to enter the password verification state. After the password verification is successful, enter the modification state, enter the new password, and press the key to confirm, the password change is successful, and the password will automatically take effect after 3 minutes.

Please keep the password properly. If you forget it, please ask the manufacturer for service.

00.24	Frequency display resolution selection	
	0~1	0

0: 0.1 Hz (0.0~999.9 HZ)

1: 1 Hz (0~999 HZ)

Group 01-auxiliary operating parameters

01.00	Starting method	
	00~12	00

LED units: start mode

0: Start from the starting frequency

Start according to the set starting frequency (01.01).

1: DC braking + starting frequency start

Perform DC braking first (see 01.03), and then start according to mode 0.

2: reserved

LED ten digits: restart mode after power failure or abnormal

0: invalid

When the power is turned on after a power failure, the inverter will not run automatically.

1: Start from the starting frequency

When the power is turned on after a power failure, if the starting conditions are met, the inverter will automatically start to run from the starting frequency point.

01.01	Starting frequency	
	0.00~50.00Hz	1.00

The starting frequency refers to the initial frequency when the inverter starts. For some systems with relatively large starting torque, setting a reasonable starting frequency can effectively overcome the problem of starting difficulties.

01.02	Starting DC braking current	
	0.0~150.0%*Motor rated current	0.0%
01.03	Start DC braking time	
	0.0~100.0s	0.0

The setting of starting DC braking current is the percentage relative to the rated output current of the inverter.

When the starting DC braking time is 0.0s, there is no DC braking process. The details are shown in the figure below.

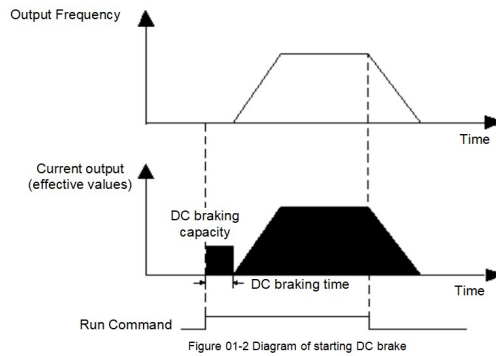

Fig. 01-1 Schematic diagram of starting DC braking

01.04	Stop mode	
	0~1	0

0: Decelerate to stop

After receiving the stop command, the inverter will gradually reduce the output frequency according to the deceleration time, and stop after the frequency drops to zero. If the stop DC braking function is valid, after reaching the start frequency of the stop DC braking (according to the 01.05 setting, there may be a waiting time for the stop DC braking), the DC braking process will be executed and the machine will stop.

1: Free stop

After the inverter receives the stop command, it immediately terminates the output, and the load stops freely according to the mechanical inertia.

01.05	Start frequency of DC braking during stop	
	0.0~【00.05】 upper limit frequency	0.00
01.06	Stop DC braking Voltage	
	0.0~150.0%* rated Voltage of motor	0.0%
01.07	Time for DC braking during stop	
	0.0~30.0S	0S
01.08	Waiting time for DC braking during stop	
	0.0:DC braking does not work 0.1~99.99s	0.0

The set value of the stop DC braking current is the percentage relative to the rated current of the inverter. When the braking time at stop is 0.0s, there is no DC braking process. As shown below.

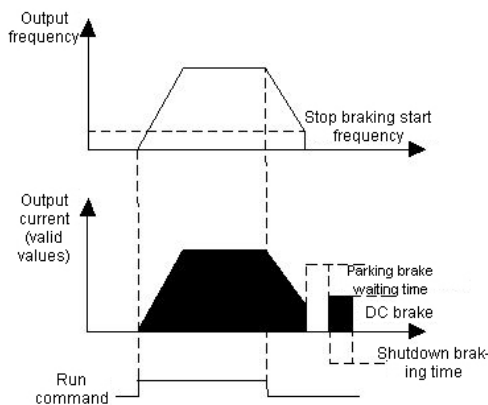

Fig. 01-2 Schematic diagram of DC braking at stop

01.09	Forward jog frequency	
	0.00~【00.05】	10.00
01.10	Reverse jog frequency	
	0.00~【00.05】	10.00
01.11	Jog acceleration time	
	0.1~999.9s	Model setting

01.12	Jog deceleration time	
	0.1~999.9s	Model setting

01.09~01.12 define the relevant parameters during jog operation. As shown in Figure 01-3, t1 and t3 are the actual jog acceleration and deceleration time; t2 is the jog time; f1 is the forward jog operation frequency (01.09); f2 is the reverse jog operation frequency (01.10). The actual jog acceleration time t1 is determined according to the following formula:

$$t1=01.09*01.11/00.04$$

In the same way, the actual jog deceleration time t3 can also be determined as follows:

$$t3=01.10*01.12/00.04$$

Among them, 00.06 is the maximum output frequency.

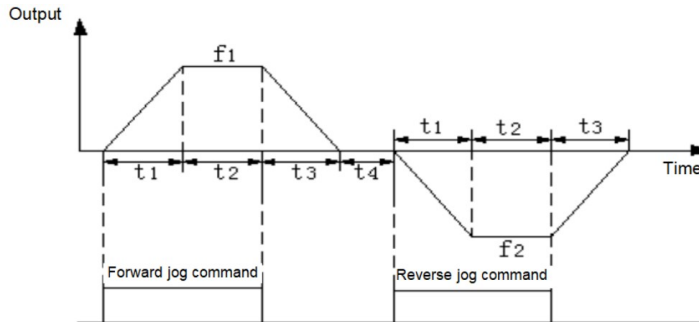

Figure 01-3 Jog operation diagram

01.13	Jump frequency	
	0.0~Upper limit frequency	0.0
01.14	Jump range	
	0.0~Upper limit frequency	0.0

The above function codes are functions set to make the output frequency of inverter avoid the resonance frequency point of mechanical load. The set frequency of the inverter can be given by jumping near some frequency points according to the following figure. Its specific meaning is that the frequency of the inverter will never run stably within the jumping frequency range, but will pass through this range during acceleration and deceleration.

00.15	Frequency source combination given method	
	0~8	0

- 0: Potentiometer+digital frequency 1
- 1: Potentiometer+digital frequency 2
- 2: Potentiometer +AI
- 3: Digital frequency 1+AI
- 4: Digital frequency 2+AI
- 5: Digital frequency 1+ multi-speed
- 6: Digital frequency 2+ multi-speed
- 7: Potentiometer+Multistage Speed
- 8: AI+PLC (superposition in the same direction)

01.16	Programmable operation control (simple PLC operation)	
	0000~1221	00000

LED units: PLC enable control

0: invalid

1: Effective

LED ten digits: operation mode selection

0: single loop

After the inverter completes a single cycle, it will stop automatically. At this time, it needs to give the running command again to start. If the running time of a certain stage is 0, then skip this stage while running and go directly to the next stage. As shown below:

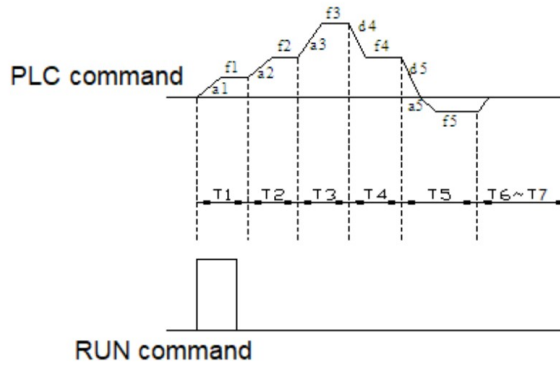

Figure 01-4 Schematic diagram of PLC shutdown after a single cycle

1: Continuous circulation

After the inverter completes a cycle, it will automatically start the next cycle, and will not stop until a stop command is issued. As shown below:

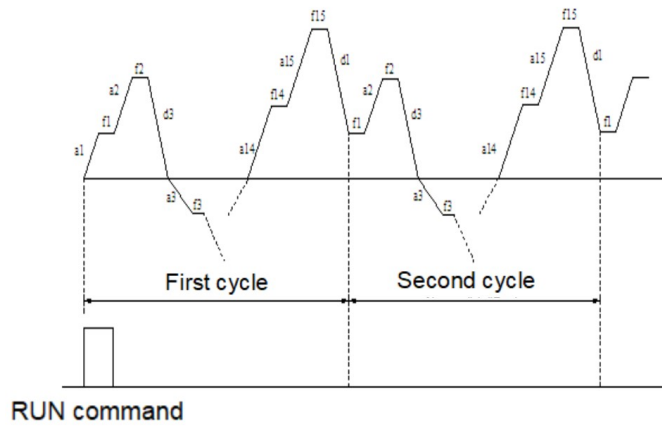

Figure 01-5 PLC continuous cycle diagram

2: Keep the final value after a single cycle

After the inverter completes a single cycle, it automatically maintains the operating frequency and direction of the last segment to operation. As shown below:

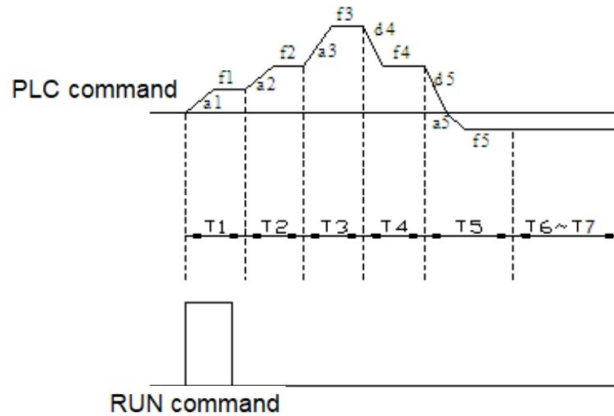

Fig. 01-6 The schematic diagram of PLC holding after a single cycle

Hundreds of LEDs: start mode

0: restart from the first segment

Stop during operation (caused by stop command, fault or power failure), and start to run from the first stage after restart.

1: Start from the stage at the moment of shutdown (fault)

If the inverter stops during operation (caused by a stop command, fault or power failure), the inverter will automatically record the running time of the current stage. After restarting, it will automatically enter this stage and continue to run for the remaining time at the frequency defined in this stage, as shown in the figure below:

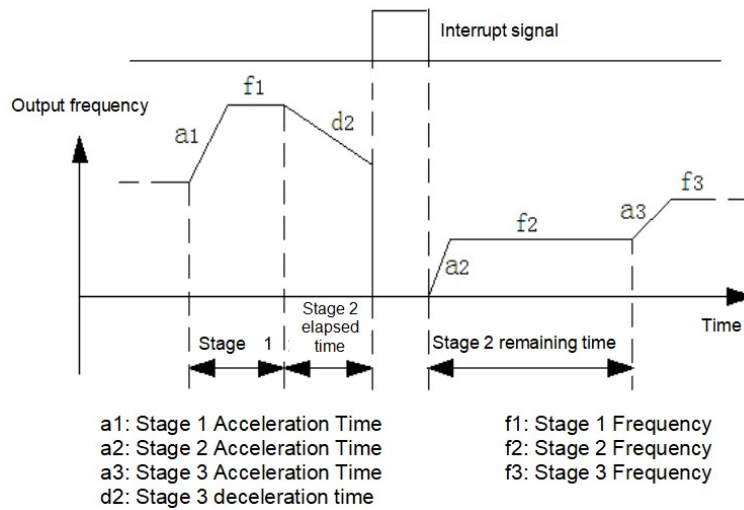

Fig. 01-7 PLC start mode 1

2: Start from the stage and frequency of shutdown (failure) time

In case of shutdown during operation (caused by shutdown command, fault or power failure), the inverter not only automatically records the running time at the current stage but also records the running frequency at the shutdown time, and then recovers to the running frequency at the shutdown time after starting again, and the remaining phases of the frequency run, as shown in the following figure:

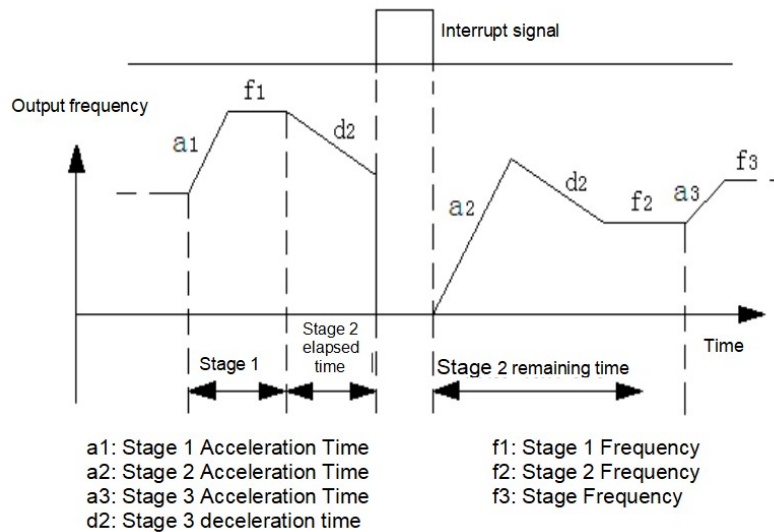

Fig. 01-8 PLC start mode 2

Thousands of LEDs: power-down storage options

0: do not store

The PLC running state is not memorized when the power is off, and it starts to run from the first stage after power-on.

1: storage

The PLC running status is memorized when the power is off, including the stage at the time of power down, the running frequency, and the running time. Restart after power-on, it will automatically enter this stage, and continue to run for the remaining time at the frequency defined in this stage.

01.17	Multi-speed frequency 1	
	-Upper limit frequency ~ +upper limit frequency	5.0
01.18	Multi-speed frequency2	
	-Upper limit frequency ~ +upper limit frequency	10.0

01.19	Multi-speed frequency 3	
	-Upper limit frequency ~ +upper limit frequency	15.0
01.20	Multi-speed frequency 4	
	-Upper limit frequency ~ +upper limit frequency	20.0
01.21	Multi-speed frequency 5	
	-Upper limit frequency ~ +upper limit frequency	25.00
01.22	Multi-speed frequency 6	
	-Upper limit frequency ~ +upper limit frequency	37.5
01.23	Multi-speed frequency 7	
	-Upper limit frequency ~ +upper limit frequency	50.0

The sign of multi-speed determines the direction of operation, and negative means operation in the opposite direction. The start-stop command is set by 00.02.

01.24	Stage 1 running time (the unit is selected by [01.35], and the default is seconds)	
	0.0~999.9 S	10.0
01.25	Stage 2 running time (the unit is selected by [01.35], and the default is seconds)	
	0.0~999.9 S	10.0
01.26	Stage 3 running time (the unit is selected by [01.35], and the default is seconds)	
	0.0~999.9 S	10.0
01.27	Stage 4 running time (the unit is selected by [01.35], and the default is seconds)	
	0.0~999.9 S	10.0
01.28	Stage 5 running time (the unit is selected by [01.35], and the default is seconds)	
	0.0~999.9 S	10.0
01.29	Stage 6 running time (the unit is selected by [01.35], and the default is seconds)	
	0.0~999.9 S	10.0
01.30	Stage 7 running time (the unit is selected by [01.35], and the default is seconds)	
	0.0~999.9 S	10.0

The above function code is used to set the running time of the programmable multi-speed. The 7-segment running time can be set separately by the X-segment running time.

01.31	Stage Select 1 for acceleration and deceleration time	
	0000~1111	0000

LED bit: Stage 1 acceleration and deceleration time

0~1

LED ten bits: Stage 2 Acceleration and deceleration time

0~1

LED hundred bits: Stage 3 Acceleration and deceleration time

0~1

LED thousand bits: Stage 4 Acceleration and deceleration time

0~1

Note:

0: Acceleration and deceleration time 1 【00.10~00.11】

1: Acceleration and deceleration time 2 【01.33~01.34】

01.32	Stage Select 2 for acceleration and deceleration time	
	0000~1111	0000

LED bit: Stage 5 acceleration and deceleration time
 0~1
 LED ten bits: Stage 6 acceleration and deceleration time
 0~1
 LED hundred bits: Stage 7 acceleration and deceleration time
 0~1
 LED thousand bits: Reserved

01.33	Acceleration time 2	10.0
	0.1~999.9 s	
01.34	Deceleration time 2	10.0
	0.1~999.9 s	

Two groups of acceleration/deceleration time can be defined, and the acceleration/deceleration time 1~2 during inverter operation can be selected through different combinations of control terminals. Please refer to the definition of acceleration/deceleration time terminal function in 02.13~02.17.

01.35	Time unit selection	000
	000~211	

LED bit: process PID time unit
 LED ten bits: simple PLC time unit
 LED hundred bits: regular acceleration and deceleration time unit
 LED thousand bits: reserved
 0: 1 second
 1: 1 minute
 2: 0.1 second
 This function code defines the dimension of acceleration and deceleration time.

01.36	Forward and reverse dead time	0.0
	0.0~999.9s	

The waiting time for the inverter to transition from forward running to reverse running, or from reverse running to forward running, is t_1 as shown in the figure below.

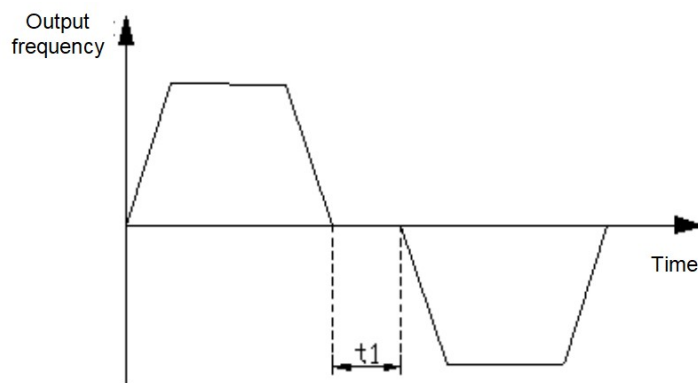

Figure 01-7 Schematic diagram of forward and reverse dead time

Figure 01-9 Schematic diagram of forward and reverse dead time

Group 02-analog and digital input and output parameters

02.00	AI input lower limit Voltage	0.00
	0.00V/0.00mA~ 【02.01】	

02.01	AI input upper limit Voltage	
	【02.00】 ~10.00V/20.00mA	10.00
02.02	AI lower limit corresponding setting	
	-100.0%~100.0%	0.0%
02.03	AI upper limit corresponding setting	
	-100.0%~100.0%	100.0%
02.04 ~02.07	Reserved	Reserved
02.08	The analog input Signal filtering time constant.	
	0.1~5.0s	0.1

The above function codes define the input range of analog input voltage channel AI and its corresponding physical quantity percentage and filter time constant. It can be selected as voltage/current input through the J5 jumper, and its digital setting can be set according to the relationship of 0~20mA corresponding to 0~10V. The specific setting should be determined according to the actual situation of the input signal.

The AI input filter time constant is mainly used to filter the analog input signal to eliminate the influence of interference. The larger the time constant, the stronger the anti-interference ability and the more stable the control, but the slower the response; conversely, the smaller the time constant, the faster the response, but the weaker the anti-interference ability, the control may be unstable. If the optimal value cannot be determined in practical applications, the value of this parameter should be adjusted appropriately according to whether the control is stable and the response delay.

02.09	Analog input anti-shake deviation limit	
	0.00V~10.00V	0.10

When the analog input signal fluctuates frequently near the given value, you can set 02.09 to suppress the frequency fluctuation caused by this fluctuation.

02.10	AO multifunctional analog output terminal function selection	
	0-5	0

The above function codes determine the corresponding relationship between the multi-function analog output terminal AO and each physical quantity, as shown in the following table:

Set	Function	AO	Range
0	Output frequency	0V/0mA~AO upper limit	0~Maximum output frequency
		2V/4mA~AO upper limit	0~Maximum output frequency
1	Output current	0V/0mA~AO upper limit	0~2 times rated current
		2V/4mA~AO upper limit	0~2 times rated current
2	Motor speed	0V/0mA~AO upper limit	0~Motor synchronous speed
		2V/4mA~AO upper limit	0~Motor synchronous speed
3	The output voltage	0V/0mA~AO upper limit	0~1.2 times rated output voltage
		2V/4mA~AO upper limit	0~1.2 times rated output voltage
4	AI	0V/0mA~AO upper limit	0V/0mA~10V/20mA
		2V/4mA~AO upper limit	0V/0mA~10V/20mA
5	Reserved	-	-

02.11	AO1 output lower limit	
	0.00~10.00V	0.00
02.12	AO output upper limit	
	0.00~10.00V	10.00V

The above function code defines the corresponding relationship between the output value and the analog output. When the output value exceeds the set maximum output or minimum output range, it will be calculated as the upper limit output or the lower limit output.

02.13	Input terminal DI1 function	
	0~30	3
02.14	Input terminal DI2 function	
	0~30	4
02.15	Input terminal DI3 function	
	0~30	0
02.16	Input terminal DI4 function	
	0~30	0
02.17	Input terminal DI5 function	
	0~30	0

0: Reserved

1: Forward jog control

If the terminal is short-circuited with GND, the inverter will run in forward jog mode, which is only valid when 00.02=1.

2: Reverse jog control

If the terminal is short-circuited with GND, the inverter will run in reverse jog mode, which is only valid when 00.02=1.

3: Forward running (FWD)

If the terminal is short-circuited with GND, the inverter will run forward, which is only valid when 00.02=1.

4: Reverse operation (REV)

If the terminal is short-circuited with GND, the inverter will run in reverse, which is only valid when 00.02=1.

5: Three-line operation control

Refer to 02.18 for the function description of operation mode 2, 3, 4 (three-wire control mode 1, 2, 3).

6: Free stop control

This function has the same meaning as the free-running stop defined in 01.04, but here is realized by the control terminal, which is convenient for remote control.

7: External stop signal input (STOP)

This function is used in emergency stop situations, the terminal is short-circuited with GND, and the stop is decelerated by the deceleration time (00.11).

8: External reset signal input (RST)

When a fault occurs in the inverter, the fault can be reset through this terminal. Its function is the same as that of the key . This function is valid under any command channel.

9: External equipment failure normally open input

Through this terminal, the fault signal of the external equipment can be input, which is convenient for the inverter to monitor the fault of the external equipment. After the inverter receives the external equipment failure signal, it will display "E-EF", that is, the external equipment failure alarm, and the failure signal can adopt the normally open input mode.

10: Frequency increment command

When the terminal is short-circuited with GND, the frequency will increase. It is valid only when the frequency setting channel is digital setting 2 (terminal UP/DOWN adjustment).

11: Frequency decreasing instruction

If the terminal is short-circuited with GND, the frequency will decrease. It is valid only when the frequency setting channel is digital setting 2 (terminal UP/DOWN adjustment).

13: Multi-speed selection S1

14: Multi-speed selection S2

15: Multi-speed selection S3

By selecting the ON/OFF combination of these function terminals, up to 7 speeds can be selected. The details are shown in the following table:

S3	S2	S1	Stage speed
OFF	OFF	ON	1
OFF	ON	OFF	2
OFF	ON	ON	3
ON	OFF	OFF	4
ON	OFF	ON	5
ON	ON	OFF	6
ON	ON	ON	7

16: The run command channel is forced to be a terminal

When this terminal is valid, the running command is forcibly converted from the current channel to terminal control, disconnect the terminal and return to the previous running command channel.

17: The run command channel is forced to be communication

When this terminal is valid, the running command is forcibly converted from the current channel to communication control, disconnect the terminal, and return to the previous running command channel.

18: Stop DC braking command

When this terminal is valid, the inverter directly switches to the DC braking state.

19: Frequency switch to AI

When this terminal is valid, the inverter frequency setting switch AI.

20: frequency switch to digital frequency 1

When this terminal is valid, the inverter frequency setting switches to digital frequency 1.

21: frequency switch to digital frequency 2

When this terminal is valid, the inverter frequency setting switches to digital frequency 2.

22: Reserved

23: Counter clear signal

The terminal is short-circuited with GND to clear the internal counter and use it in conjunction with the 24th function.

24: Counter trigger signal

The count pulse input port of the internal counter receives a pulse, the count value of the counter increases by 1 (if the counting mode is down counting, then decreases by 1), and the maximum frequency of the count pulse is 200 Hz.

25: Timer clear signal

The terminal is short-circuited with GND to clear the internal timer and use it in conjunction with function No. 26.

26: Timer trigger signal

The trigger port of the internal timer.

27: Acceleration and deceleration time selection

By selecting these function terminals to be valid, select the second type of acceleration and deceleration time.

28: Swing frequency pause (stop at the current frequency)

When the terminal is short-circuited with GND, the inverter suspends the swing frequency operation mode, the inverter frequency stops running at the current frequency; the swing frequency operation continues after this terminal is invalid.

29: Swing frequency reset (return to center frequency)

When this function is selected, whether it is automatic or manual input mode, closing this terminal will clear the wobble frequency status information stored in the inverter. After disconnecting this terminal, the wobble frequency restarts (if there is a preset frequency, run the preset frequency first).

30: External stop/reset signal input (STOP/RST)

In any control mode (panel control, terminal control, communication control), this terminal can be used to decelerate and stop the inverter.

Use the terminal to perform the fault reset function. It has the same function as the RESET key on the keyboard. Use this function to realize remote fault reset.

02.18	FWD/REV terminal control mode	
	0~5	0

This function code defines four different ways to control the operation of the inverter through external terminals.

0: Two-wire control mode 1

Xm: Forward rotation command (FWD), Xn: Reverse rotation command (REV), Xm and Xn represent any two terminals of DI1-DI5 defined as FWD and REV functions respectively. In this control mode, K1 and K2 can independently control the operation and direction of the inverter

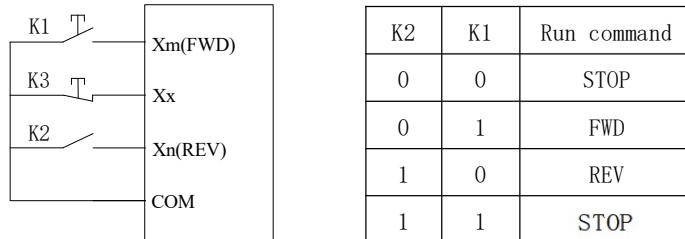

Figure 02-1 Schematic diagram of two-wire control mode 1

1: Two-wire control mode 2

Xm: Forward rotation command (FWD), Xn: Reverse rotation command (REV), Xm and Xn represent any two terminals of DI1-DI5 defined as FWD and REV functions respectively. In this control mode, K1 is the run and stop switch, and K2 is the direction switch.

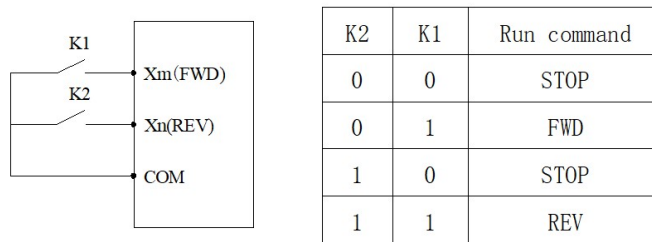

Figure 2-2 Schematic diagram of two-wire control mode 2

2: Three-wire control mode 1

Xm: Forward rotation command (FWD), Xn: Reverse rotation command (REV), Xx: Stop command, Xm, Xn, Xx represent any 3 terminals of DI1-DI5 defined as FWD, REV, and three-wire operation control functions respectively. When K3 is connected, K1 and K2 are invalid. When K3 is triggered, the inverter rotates forward; K2 is triggered, the inverter stops. When K3 is disconnected, the connected K1 and K2 are invalid. When K3 is connected, K1 is triggered, the inverter rotates forward; K2 is triggered separately, which is invalid; after K1 is triggered to run, K2 is triggered again to switch the running direction of the inverter; K3 is disconnected, and the inverter stops.

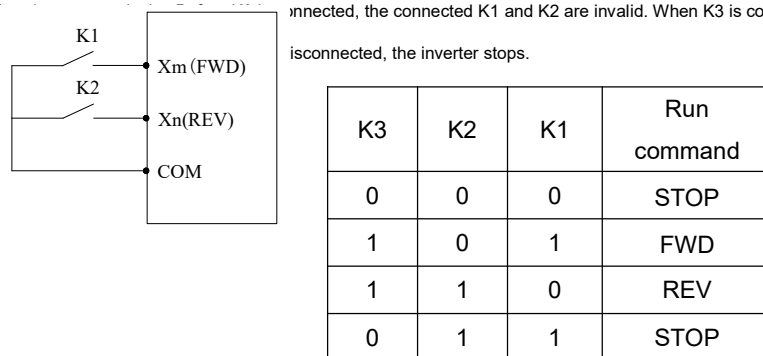

Figure 2-3 Schematic diagram of three-wire control mode 1

3: Three-wire control mode 2

Xm: run command, Xn: run direction selection, Xx: stop command, Xm, Xn, Xx represent any 3 terminals of DI1-DI5 defined as FWD, REV, and three-wire operation control functions. Before K3 is connected, the connected K1 and K2 are invalid. When K3 is connected, K1 is triggered, and the inverter rotates forward; K2 is triggered separately, which is invalid; after K1 is triggered to run, K2 is triggered again to switch the running direction of the inverter; K3 is disconnected, and the inverter stops.

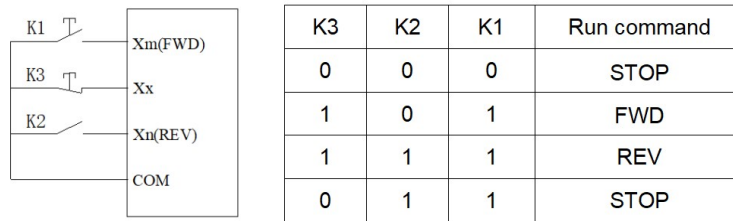

Figure 2-4 Schematic diagram of three-wire control mode 2

02.19	Selection of terminal function detection when power on	
	0~1	0

0: Terminal running command is invalid when power on

During the power-on process, even if the inverter detects that the run command terminal is valid (closed), the inverter will not start. The inverter can only start when the terminal is disconnected and closed again.

1: The terminal running command is valid when the power is on

During the power-on process, the inverter detects that the terminal run command terminal is valid (closed), and the inverter can start.

02.20	R output setting	
	0~17	5
02.21	Y Open collector output	
	0~17	0

0: Reserved

1: The inverter is ready to run

When the power-on is ready, that is, the inverter has no fault, the bus voltage is normal, the inverter's terminal forbidden to run is invalid, and it can be started directly by accepting the running command (excluding the inverter's running), the terminal will output an indication signal.

2: The inverter is running

When the inverter is in forward and reverse running state, the output indicator signal.

3: The inverter is running at zero speed

The output frequency of the inverter is 0.00Hz, but it is the indication signal output when it is still in the running state.

4: External fault shutdown

When the inverter has an external fault, the output indicator signal.

5: Inverter failure

When the inverter has a fault, the output indicator signal, refer to the setting of the multi-function input terminal.

6: Frequency/speed arrival signal (FAR)

Refer to 02.24 parameter function description.

7: Frequency/speed level detection signal (FDT)

Refer to the parameter function description of 02.24~02.25.

8: The output frequency reaches the upper limit

When the output frequency of the inverter reaches the upper limit frequency, the output indicator signal.

9: The output frequency reaches the lower limit

When the output frequency of the inverter reaches the lower limit frequency, the output indicator signal.

10: Inverter overload pre-alarm

When the output current of the inverter exceeds the overload pre-alarm level (05.10), the output indicator signal after the alarm delay time (05.11) has elapsed. It is often used for overload pre-alarm.

11: Timer overflow signal

When the actual timing time is ≥ 07.03 (set timing time), the indicator signal is output.

12: Counter detection signal

When the count detection value is reached, the output indicator signal will be cleared until the count reset value is reached. Please refer to the description of function code 07.02.

13: Counter reset signal

When the count reset value is reached, an indication signal is output, please refer to the description of function code 07.01.

14: auxiliary motor

Auxiliary motor and terminal function coordination process PID function module can realize simple one-to-two constant pressure water supply function.

15: Forward

When the inverter is in the forward running state, the output indicator signal.

16: Reverse

When the inverter is in the reverse running state, the output indicator signal.

17: Output indication signal when the output frequency drops to the speed detection level

When the output frequency of the inverter drops to the level of speed detection [02.25], an indication signal is output.

02.22	R close delay	
	0.0~255.0s	0.0
02.23	R open delay	
	0.0~255.0s	0.0

This function code defines the delay from the change of the state of the relay to the change of the output.

02.24	Frequency reaches FAR detection amplitude	
	0.0Hz~15.0Hz	5.0

When the output frequency is within the positive and negative detection width of the set frequency, the terminal outputs an effective signal (low level).

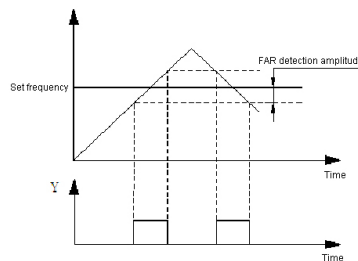

Figure 02-5 Schematic diagram of frequency arrival

02.25	FDT1 level setting value	
	0.0Hz~Upper limit frequency	10.0
02.26	FDT lag value	
	0.0~30.0Hz	1.0

When the output frequency of the inverter rises and exceeds the set value of FDT level, it outputs a valid signal (open collector signal, low level after the resistance is pulled up), when the output frequency drops below the FDT signal (set Value- hysteresis value), an invalid signal (high impedance state) is output. As shown below:

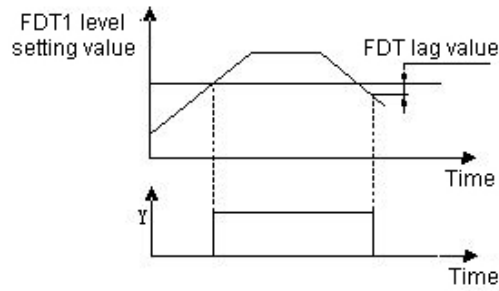

Figure 02-6 Schematic diagram of frequency level detection

02.27	UP/DOWN terminal modification rate	
	0.0Hz~99.9Hz/s	1.0

The function code is the frequency modification rate when setting the UP/DOWN terminal as frequency set , that is, the UP/DOWN terminal is short-circuited with the GND terminal for 1s, and the frequency changes.

02.28	Input terminal pulse trigger mode setting (DI1~DI5)	
	0~1FH	0

0: indicates the electrical level trigger mode

1: indicates the pulse trigger mode

Note:

DI1~DI5 correspond to 1H, 2H, 4H, 8H and 10H in hexadecimal.

02.29	Input terminal valid logic setting (DI1~DI5)	
	0~1FH	0

0: indicates positive logic, that is, the DI terminal is connected to GND and GND is valid, and the disconnection is invalid

1: It means anti-logic, that is, DI terminal is not connected to the GND terminal and GND is invalid, and the disconnection is valid

Note:

DI1~DI5 correspond to 1H, 2H, 4H, 8H and 10H in hexadecimal.

02.30	DI1 filter coefficient	
	0~9999	5
02.31	DI2 filter coefficient	
	0~9999	5
02.32	DI3 filter coefficient	
	0~9999	5
02.33	DI4 filter coefficient	
	0~9999	5
02.34	DI5 filter coefficient	
	0~9999	5

Used to set the sensitivity of the input terminal. If the digital input terminal is susceptible to interference and causes misoperation, this parameter can be increased to enhance the anti-interference ability, but the sensitivity of the input terminal will be reduced if the setting is too large.

1: represents 2ms scanning time unit

03 group -PID parameters

03.00	PID function setting	
	0000~2122	1010

LED bit: PID regulation characteristics

0: invalid

1: positive effect

When the feedback signal is greater than the given quantity of PID, the output frequency of the inverter is required to decrease (that is, reduce the feedback signal).

2: negative effect

When the feedback signal is greater than the given quantity of PID, the output frequency of the inverter is required to rise (that is, reduce the feedback signal).

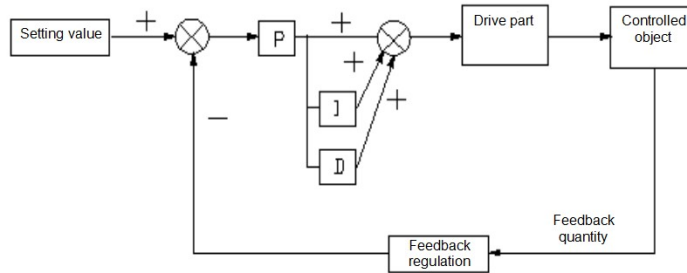

LED ten bits: PID given input channel

0: keypad potentiometer

PID given quantity is given by potentiometer on the keypad.

1 Number given

PID given quantity is given by numbers and set by function code 03.01.

2 Given pressure (MPa, Kg)

Set the given pressure on 03.01 and 03.18.

LED hundred digits: PID feedback input channel

0: AI

1: Reserved

LED thousand bits: PID sleep selection

0: invalid

1: normal sleep

Specific parameters such as 03.10 ~ 03.13 should be set in this method.

2. Disturbed sleeping

The parameter setting is the same as when the sleep mode is selected as 0. If the PID feedback value is within the range of the set value of 03.14, the sleep delay time will be maintained and then the disturbance sleep will be entered. When the feedback value is less than the wake-up threshold (PID polarity is positive), wake up immediately.

03.01	Given a numerical setting	
	0.0~100.0%	0.0

When analog feedback is used, this function code realizes the setting of the closed-loop control setting with the operation panel. This function is valid only when the closed-loop setting channel selects the digital setting (the tens place of 03.00 is 0).

Example: In the constant pressure water supply closed-loop control system, the setting of this function code should fully consider the relationship between the range of the remote pressure gauge and its output feedback signal. For example, the range of the pressure gauge is 0~10MPa, corresponding to 0~10V voltage output. We need a pressure of 6MPa, then the given digital quantity can be set to 6.00V, so that when the PID adjustment is stable, the required pressure is 6MPa.

03.02	Feedback channel gain	
	0.01~10.00	1.00

When the feedback channel is inconsistent with the set channel level, this function can be used to adjust the gain of the feedback channel signal.

03.03	Proportional gain P	
	0.01~5.00	2.00
03.04	Integration time Ti	
	0.1~50.0s	1.0
03.05	Derivative time Td	
	0.1~10.0s	0.0

Proportional gain (Kp):

The adjustment intensity of the whole PID regulator is determined by this. And the greater the P is, the greater the adjustment intensity is. But if in too large state, there is easy to produce oscillation.

When the feedback deviates from the set value, the deviation and output become the regulating value of proportion. If the deviation is constant, the regulating value is also constant. Proportional adjustment can quickly show out the feedback changes, but it is impossible to achieve error-free control by proportional control alone. The larger the proportional gain is, the faster the adjustment speed of the system will be, but if too large, oscillation will occur. The adjustment method is to set the integration time for a longer time, and the differentiation time for zero, then use proportional control to make the system run. With changing the size of the given quantity, it can observe the stable deviation (static difference) between the feedback signal and the set value. If the static difference changes in the direction of the set value (for example, if the set value is increased and the feedback value is always less than the set value after the system is stable), then increasing the proportional gain continues. Otherwise reduce the proportional gain, and repeat the above process until the static difference is relatively small (It's hard to make it without any static errors)

Integral time (ti):

Determine the speed of PID regulators to do the integral adjustment of deviation.

When the feedback deviates from the set value, the output adjustment value need to continuously accumulate. And if the deviation persists, the adjustment value continuously increases until there is no deviation. Integral regulator can validly eliminate static difference. If the integral regulator is too strong, there will be repeated overshoot, which will make the system oscillate. Generally, the adjustment of integration time parameters is from large to small, and the integration time is gradually adjusted, while the effect of system adjustment is observed, all until the stable speed of the system meets the requirements.

Differential time (Td):

Determine the strength of PID regulator to adjust the rate of deviation change.

When the feedback changes with the set deviation, the rate of deviation change and output become the regulating value of proportion, which is only related to the direction and magnitude of deviation change, but has nothing to do with the direction and magnitude of deviation itself. when the feedback signal changes, the function of derivative adjustment is to adjust according to the changing trend of it, so as to restrain the change of it. Please use derivative regulator with caution, because derivative regulator is easy to amplify the interference of the system, especially the interference from large changing frequency.

03.06	Sampling period T	
	0.1~10.0s	0.0

The larger the sampling period, the slower the response, but the better the interference signal suppression effect, so it is generally unnecessary to set it.

03.07	Deviation limit	
	0.1~20.0%	0.0

The deviation limit is the ratio of the absolute value of the deviation between the system feedback quantity and the given quantity to the given quantity. When the feedback quantity is within the deviation limit, the PID adjustment will not operate. As shown in the figure below, setting a reasonable deviation limit can prevent the system from reaching the target. Frequent adjustment near the value will help improve the stability of the system.

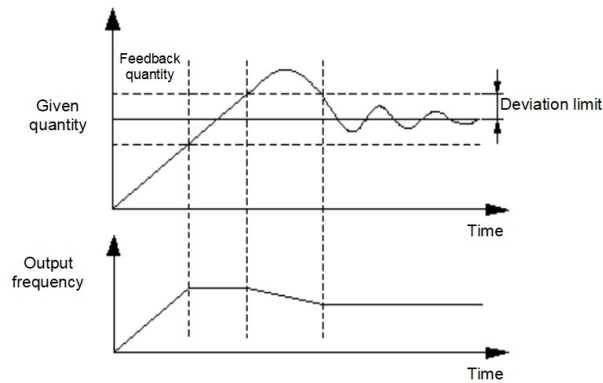

Figure 03-2 Schematic diagram of deviation limit

03.08	Closed loop preset frequency	
	0.0 ~ upper limit frequency	0.0
03.09	Preset frequency holding time	
	0.0~999.9s	0.0

This function code defines the frequency and running time of the inverter before the PID is put into operation when PID control is valid. In some control systems, in order to make the controlled object reach a predetermined value quickly, the inverter is set according to this function code to force a certain frequency value of 03.08 and a frequency holding time of 03.09 to be output. That is, when the control object is close to the control target, the PID controller is put in to improve the response speed. As shown below:

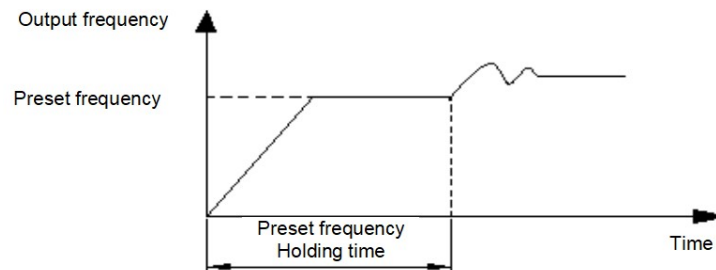

Figure 03-2 Schematic diagram of closed-loop preset frequency operation

03.10	Sleep threshold coefficient	
	0.0~150.0%	100.0

03.11	Awakening threshold coefficient	
	0.0~150.0%	90.0
03.12	Sleep delay time	
	0.0~999.9s	1.0
03.13	Wake delay time	
	0.0~999.9s	1.0

03.10 defines the feedback limit when the inverter enters the sleep state from the working state. If the actual feedback value is greater than the set value, and the frequency of the inverter output reaches the lower limit frequency, the inverter will enter the sleep state (that is, running at zero speed) after the delay waiting time defined in 03.12.

03.11 defines the feedback limit of the inverter from the sleep state to the working state. When the PID polarity is selected as the positive characteristic, if the actual feedback value is less than the set value (or when the PID polarity is selected as the negative characteristic, if the actual feedback value is greater than the set value), the inverter passes the defined value of 03.13 After delaying the waiting time, it leaves the sleep state and starts to work.

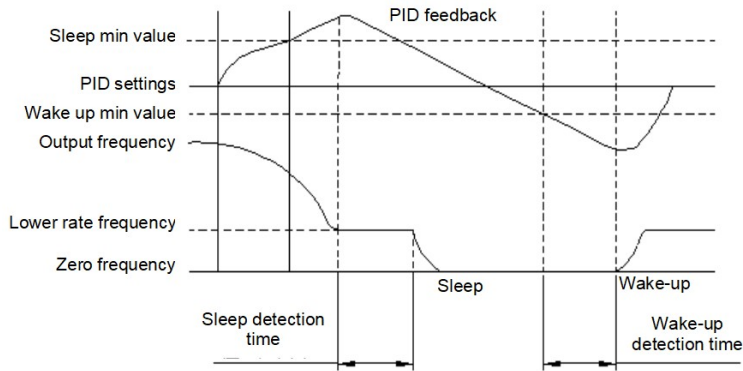

Figure 03-3 Schematic diagram of the first normal sleep mode

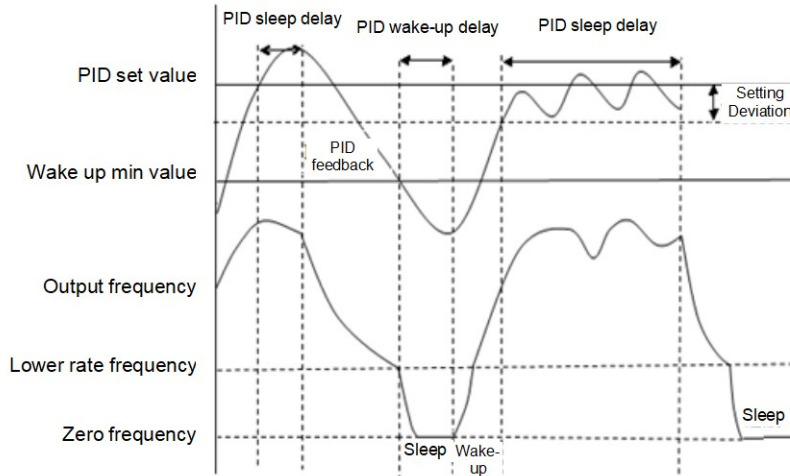

Figure 03-4 Schematic diagram of the second disturbed sleep mode

03.14	Deviation between feedback and set pressure when entering sleep	
	0.0~999.9s	1.0

This function parameter is only valid for disturbance sleep mode

03.15	Delay time of burst detection	
	0.0~130.0s	0.0

When the feedback pressure is greater than or equal to this set value, the pipe burst fault "EPA0" will be reported after the 03.15 burst delay. When the feedback pressure is less than this set value, the pipe burst fault "EPA0" will be automatically reset; the threshold is the given pressure Percentage.

03.16	High pressure detection threshold	
	0.0~200.0%	150.0%
03.17	Low pressure detection threshold	
	0.0~200.0%	50.0%

When the feedback pressure is greater than or equal to 03.16, the explosion failure "EPA0" will be reported after the explosion delay at 03.15, and when the feedback pressure is less than this set value, the explosion failure "EPA0" will automatically reset; The threshold is a percentage of the given pressure.

When the feedback pressure is less than 03.17, the explosion failure "EPA0" will be reported after the explosion delay at 03.15, and when the feedback pressure is greater than or equal to this set value, the explosion failure "EPA0" will automatically reset; The threshold is a percentage of the given pressure.

03.18	Measurement range of sensors	
	0.00~99.99 (MPa、Kg)	10.00MPa

Set the maximum range of the sensor

04 group -advanced functions parameters

04.00	Motor rated voltage	
	0~500V	Model setting
04.01	Motor rated current	
	0.1~999.9A	Model setting
04.02	Motor rated speed	
	0~9999RPM	Model setting
04.03	Motor rated frequency	
	1.0~999.9Hz	Model setting

The above function codes must be set according to the motor nameplate parameters. Please configure the corresponding motor according to the power of the inverter. If the power difference is too large, the control performance of the inverter will be significantly reduced.

04.04	Motor stator resistance	
	0.001~20.000Ω	Model setting
04.05	Motor no-load current	
	0.1~【04.01】	Model setting

The above are the parameters of the asynchronous motor. These parameters are generally not on the motor nameplate and need to be automatically tuned by the inverter.

If it is not possible to tune the asynchronous motor on site, you can enter the corresponding function code above according to the parameters provided by the motor manufacturer.

04.06	AVR function	
	0~2	0

- 0: invalid
- 1: the whole process is effective
- 2: invalid only when decelerating

AVR is the function of automatic voltage adjustment. When there is a deviation between the input voltage of the inverter and the rated value, this function is used to keep the output voltage of the inverter constant to prevent the motor from working in an overvoltage state. This function is invalid when the output command voltage is greater than the input power voltage. In the deceleration process, if the AVR does not act, the deceleration time is short, but the running current is large; the AVR acts, the motor decelerates smoothly, the running current is small, but the deceleration time is longer.

04.07	Cooling fan control	
	0~1	0

0: Automatic control mode

1: runs all the time during power on

04.08	Automatic fault reset times	
	0~10	0
04.09	Automatic fault reset interval	
	0.5~25.0s	3.0

After a fault occurs during operation, the inverter stops output and displays the fault code. After the reset interval set by 04.09, the inverter automatically resets the fault and restarts operation according to the set starting mode.

The number of automatic fault resets is set by 04.08. When the fault reset times is set to 0, there is no automatic reset function and can only be reset manually. For IPM faults, external device faults, etc., the inverter does not allow self-reset operation.

04.10	Energy consumption braking starting voltage	
	220V: 340~380V 360V	Model setting
	380V: 660~760V 680V	
04.11	Energy consumption braking action ratio	
	10~100%	100%

If the internal DC bus voltage of the frequency inverter is higher than the starting voltage of energy consumption braking, the built-in braking unit will act. If a braking resistor is connected at this time, the voltage energy raised inside the frequency inverter will be released through the braking resistor, and the DC voltage will fall down.

04.12	Over modulation function selection	
	0~1	0

0: invalid

1: valid

The over-modulation function means that the inverter increases the output voltage by adjusting the utilization rate of the bus voltage. When the over-modulation is effective, the output harmonics will increase. If long-term low-voltage and heavy-load operation or high-frequency (over 50HZ) operating torque is insufficient, this function can be turned on.

04.13	PWM mode	
	0~3	0

0: full frequency seven bands

The current output is stable, and the full-band power tube generates a lot of heat.

1: Full frequency five bands

The current output is stable, and the power tube generates a small amount of heat

2: Seven segments to five segments

The current output is stable, the low-frequency power tube heats up more, and the high-frequency power tube heats up less.

3: Single-phase asynchronous motor mode

The capacitor of the single-phase asynchronous motor should be removed, and then the common terminal should be connected to the inverter W, and the other two phases should be connected to the U and V of the inverter.

04.14	Slip compensation coefficient	
	0~200%	100%

After the asynchronous motor is loaded, the speed will decrease. The use of slip compensation can make the motor speed close to its synchronous speed, so that the motor speed control accuracy is higher. This coefficient is only for ordinary V/F mode.

04.15	Slip compensation mode	
	0~1	0

0: invalid

1: low frequency compensation

Note: This parameter is only valid for advanced V/F.

04.16	Self-learning of motor parameters	
	0~1	0

0: invalid

1: Static self-learning.

Set correct motor parameters in 04.00/01/02/03, then set 00.02=0, then set 04.16=1, press "RUN", STAR is displayed immediately . After finished, END is displayed and disappears after 1s

04.17	Motor rated Power		Model setting
	0.0~2000.0KW		
04.18	Rotor resistance of motor		Model setting
	0.00~200.00Ω		
04.19	Inductance of stator and rotor of motor		Model setting
	0.00~200.00mH		
04.20	Mutual inductance between stator and rotor of motor		Model setting
	0.00~200.00mH		

After the rated power of the motor is changed to 04.17, 04.01, 04.02, 04.04, 04.05, 04.18 ~ 04.20 are automatically updated as the default parameters of the motor with corresponding power.

04.21	Speed loop 1 Proportional gain		30
	1~100		
04.22	Speed loop 1 Integral time		0.50
	0.01~10.00S		
04.23	Low frequency switching point		5.0
	0.0~10.0Hz		
04.24	Speed loop 2 Proportional gain		20
	1~100		
04.25	Speed loop 2 Integral time		1.00
	0.01~10.00S		
04.26	High frequency switching point		10.0
	【04.23】~320.0Hz		

In vector mode, the speed response characteristics of vector control are changed by setting the proportional gain p and integration time i of the speed regulator. The composition of the speed regulator (ASR) is shown in Figure F4-1. In the figure, KP is the proportional gain P, TI is the integral time I

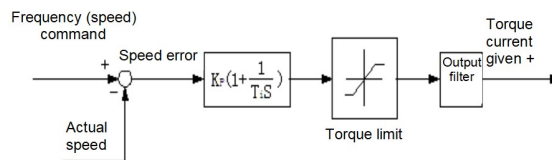

Fig. 04 -1 Simplified diagram of speed regulator

04.27	Vector Slip compensation		100
	50%~200%		

In vector control mode, this parameter is used to adjust the speed stability accuracy of the motor. When the motor is overloaded and the speed is low, increase this parameter, otherwise decrease this parameter.

04.28	Speed loop filter time constant		0.010
	0.000~1.000S		

Set the speed loop filtering time

04.30	Speed loop torque limit		150%
	0.0% ~ 200.0%		

The set value is a percentage of the rated current of the motor

05 Group- Protective Function parameters

05.00	Protection settings	
	0000~1211	0001

LED unit: motor overload protection option

0: invalid

There is no motor overload protection (use with caution).

1: Valid

As the heat dissipation effect of ordinary motors becomes worse at low speed, the corresponding motor thermal protection value should also be adjusted appropriately. The low-speed compensation feature mentioned here is just

It is to lower the overload protection threshold of the motor whose operating frequency is lower than 30Hz.

LED Ten bits: PID feedback disconnection protection

0: invalid

1: protection action and free stop

LED hundred bits: 485 communication failure handling

0: protection action and free stop

1: alarm but maintain the status operation;

2: alarm and stop in the set way

LED thousand bits: Oscillation Suppression

0: invalid

1: valid

When the oscillation suppression is effective, the PWM mode is forced to five-stage.

05.01	Motor overload protection coefficient	
	30%~110%	100%

In order to implement effective overload protection for different types of load motors, it is necessary to reasonably set the overload protection coefficient of the motor and limit the maximum current value that the inverter can output. The motor overload protection factor is the percentage of the rated current value of the motor to the rated output current value of the inverter.

When the inverter drives a motor with a matching power level, the motor overload protection coefficient can be set to 100%. As shown below:

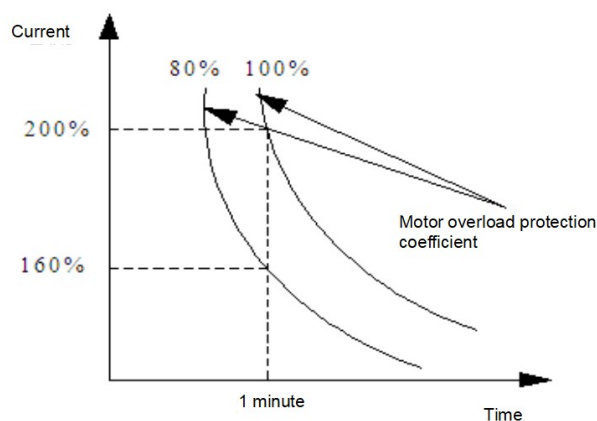

Figure 05-1 Motor overload protection curve

When the capacity of inverter is larger than that of motor, in order to implement valid overload protection for load motors of different specifications, it is necessary to set the overload protection coefficient of motor reasonably as shown in the following figure:

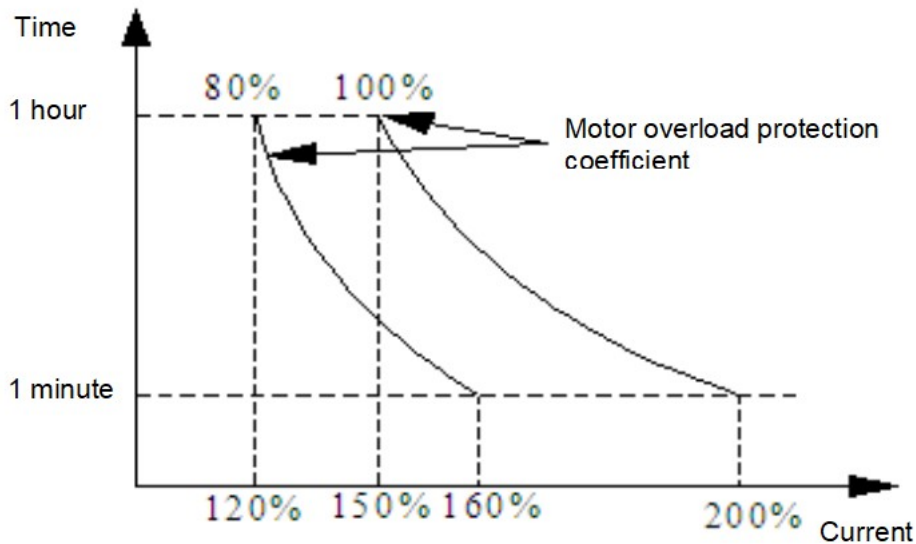

Figure 5-2 Schematic diagram of motor overload protection coefficient setting

The motor overload protection coefficient can be determined by the following formula:

$$\text{Overload protection coefficient of motor} = \frac{\text{maximum allowable load current}}{\text{rated output current of inverter}} \times 100\%$$

Generally, the maximum load current refers to the rated current of the load motor. Adjustment of protection value in line.

05.02	Undervoltage protection level		Model setting
	220V: 50~280V	180V	
	380V: 50~480V	360V	

This function code specifies the allowable lower limit voltage of the DC bus when the inverter is working normally.

When the grid voltage is too low, the output torque of the motor will drop. For constant power loads and constant torque loads, too low grid voltage will increase the input and output current of the inverter, thereby reducing the reliability of the inverter's operation. Therefore, when running for a long time under low grid voltage, the inverter power needs to be derated for use.

05.03	Voltage limiting factor during deceleration		1
	0: OFF, 1~255		

This parameter is used to adjust the ability of the inverter to suppress overvoltage during deceleration.

05.04	Overvoltage limit level		Model setting
	220V: 350~400V	375V	
	380V: 660~850V	700V	

The overvoltage limit level defines the operating voltage of the voltage stall protection.

05.05	Current limiting coefficient during acceleration		10
	0: OFF, 1~99		

This parameter is used to adjust the inverter's ability to suppress overcurrent during acceleration. During acceleration, the greater the value, the stronger the ability to suppress overcurrent.

05.06	Current limiting coefficient during constant speed		0
	0: OFF, 1~99		

This parameter is used to adjust the ability of inverter to restrain overcurrent in the process of constant speed.

05.07	Current limiting level	
	50%~200%	160%

The current limiting level defines the current threshold of automatic current limiting operation, and its set value is the percentage relative to the rated current of the inverter.

05.08	Feedback disconnection detection value	
	0.0~100.0%	0.0%

This value is the percentage of PID given quantity. When the feedback value of PID is continuously less than the feedback disconnection detection value, the inverter will make corresponding protection actions according to the setting of 05.00, and it will be invalid when 05.08=0.0%.

05.09	Feedback disconnection detection time	
	0.1~999.9S	10.0s

Delay time before protection action after feedback disconnection.

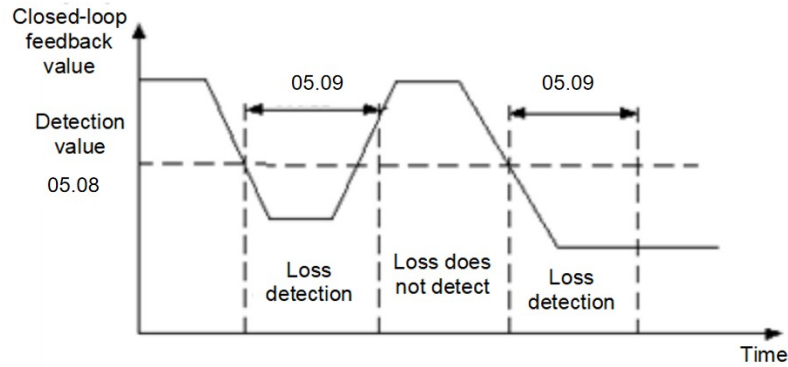

Figure 05-3 Timing diagram of closed-loop feedback loss detection

05.10	Inverter Overload pre-alarm level	
	0~150%	120%

The overload pre-alarm mainly monitors the overload condition of the inverter before the overload protection is activated. The overload pre-alarm level defines the current threshold of the overload pre-alarm action, and its set value is the percentage relative to the rated current of the inverter.

05.11	Inverter Overload pre-alarm delay	
	0.0~15.0s	5.0s

The overload pre-alarm delay defines the delay time from the inverter output current continuously greater than the overload pre-alarm level (05.10) to the output of the overload pre-alarm signal.

05.12	JOG priority enable	
	0~1	0

0: invalid

1: when the inverter is running, the jog priority is the highest

05.13	Oscillation suppression coefficient	
	0~200	30

05.14	Amplitude suppression coefficient	
	0~12	5
05.15	The Lower limit frequency of oscillation suppression	
	0.0~【05.16】	5.0Hz
05.16	The upper limit frequency of oscillation suppression	
	【05.15】~【00.05】	45.0Hz

In case of motor oscillation, it is necessary to set the effective value of 05.00 thousand bits, turn on the oscillation suppression function, and then adjust it by setting the oscillation suppression coefficient. In general, the oscillation amplitude is large, so it is unnecessary to set the oscillation suppression coefficient of 05.13, 05.14 ~ 05.16; In case of special occasions, they should be used together from 05.13~05.16.

05.17	Selection of wave-by-wave current limit	
	000~111	011

LED bit: In acceleration

0: invalid

1: valid

LED ten bits: In deceleration

0: invalid

1: valid

LED hundred-bits: In constant speed

0: invalid

1: valid

LED Thousand bits:Reserved

05.18	Output phase lost protection detection coefficient	
	0.00~20.00	2.00

When the ratio of the maximum value to the minimum value in the three-phase output current is greater than this coefficient and the duration exceeds 6 seconds, the frequency inverter reports the output current imbalance fault EPLI; ; Output open-phase protection is invalid when 05.18=0.00.

05.19	Frequency drop coefficient of instantaneous power failure	
	0: the instantaneous stop function is invalid 1~9999	0
05.20	Instantaneous power down loss frequency reduction voltage point	
	220V:180~330V 250V 380V:300~550V 450V	Model setting

If the inverter bus voltage drops below 05.20* rated bus voltage, and the instantaneous stop control is valid, the instantaneous stop starts to act.

06 group: communication parameters

06.00	Local Address	
	0~247	1

0: Broadcast address.

1~247: Slave

06.01	MODBUS communication configuration	
	0000~0322	0000

LED bit: baud rate selection

0: 9600BPS

1: 19200BPS

2: 38400BPS

This function code is used to define the data transmission rate between the host computer and the inverter. The baud rate set by the host computer and the inverter should be the same, otherwise the communication cannot be carried out. The larger the baud rate setting, the faster the data communication. Setting the conference too much affects the stability of communication.

LED ten bits: data format

0: no parity

1: even parity check

2: Odd Parity Check

The data format set by the host computer and the inverter should be consistent, otherwise normal communication will not be possible.

Hundreds of LEDs: Communication response method

0: normal response

1: Only respond to the slave address

2: No response

3: The slave does not respond to the free stop command of the master in the broadcast mode

Thousands of LEDs: reserved

06.02	Communication timeout check-out time	
	0.1~100.0s	10.0s

If the machine does not receive the correct data signal within the time interval defined by this function code, then the machine thinks that the communication has failed, and the frequency inverter will decide whether to protect or maintain the current operation according to the setting of the communication failure action mode; When this value is set to 0.0, RS485 communication timeout detection is not performed.

06.03	local device response delay time	
	0~200ms	5ms

This function code defines the intermediate time interval between receiving the data frame of the inverter and sending the response data frame to the upper computer. If the response time is less than the system processing time, the system processing time shall prevail.

06.04	Proportional linkage coefficient	
	0.01~10.00	1.00

This function code is used to set the weight coefficient of frequency instruction received by inverter as slave through RS485 interface, and the actual operating frequency of this machine is equal to the value of this function code multiplied by the value of frequency setting instruction received through RS485 interface. In the linkage control, this function code can set the ratio of operating frequency of multiple inverters.

06.05	Reserved	
	Reserved	0

07 Group- supplementary Function parameters

07.00	Counting and timing mode	
	000~303	103

LED bit: count arrival processing

0: One-cycle counting, stop output

1: One-cycle counting, continue to output

2: Cycle counting, stop output

3: Cycle counting, continue to output

When the count value of the counter reaches the value set by the function code 07.01, the inverter will execute the corresponding action.

LED ten bits: Reserved

LED hundred bits: timing arrival processing

0: One-cycle counting, stop output

1: One-cycle counting, continue to output

2: Cycle counting, stop output

3: Cycle counting, continue to output

When the timer's time reaches the value set by function code 07.03, the inverter will execute the corresponding action.

LED thousand bits: reserved

07.01	The counter reset value setting	
	【07.02】~9999	1
07.02	Setting of counter detection value	
	0~【07.01】	1

This function code defines the counting reset value and detection value of the counter. When the count value of the counter reaches the value set by the function code 07.01, the corresponding multi-function output terminal (counter reset signal output) outputs an effective signal, and the counter is cleared.

When the count value of the counter reaches the value set by the function code 07.02, an effective signal is output at the corresponding multi-function output terminal (counter detection signal output). If it continues to count and exceeds the value set by function code 07.01, when the counter is cleared, the output valid signal is cancelled.

As shown in the figure below: Set the programmable relay output as the reset signal output, the open collector output Y as the counter detection output, 07.01 as 8, and 07.02 as 5. When the detection value is "5", Y outputs an effective signal and keeps it; when it reaches the reset value "8", the relay outputs an effective signal with a pulse period and clears the counter. At the same time, Y and the relay cancel the output signal.

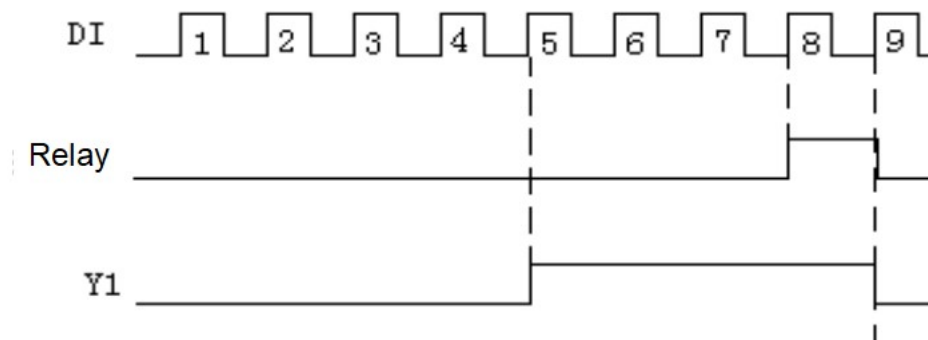

Figure 07-1 Schematic diagram of counter reset setting and counter detection setting

07.03	Timing setting	
	0~9999s	0

Set the timing time

07.08	Swing frequency control	
	0~1	0

0: prohibited
1: valid

07.09	Swing frequency control	
	0~1	0

0: fixed swing
The reference value of swing is the maximum output frequency (00.04).
1: variable swing
The reference value of the swing is the given channel frequency.

07.10	Swing frequency stop starting mode selection	
	0~1	0

0: start according to the state memorized before stop
1: restart starting

07.11	Swing frequency amplitude	
	0.0~100.0%	0.0%

The swing frequency amplitude is determined by 07.09. If 07.09=0, then the swing amplitude
 $AW = \text{Maximum output frequency} * 07.11$
If 07.09=1, then the swing
 $AW = \text{given channel frequency} * 07.11$.

07.12	Jump frequency	
	0.0~50.0%	0.0%

This function code refers to the amplitude of the rapid decrease when the frequency reaches the upper limit frequency of the traverse frequency during the swing frequency process. Of course, it also refers to the amplitude of the rapid increase after the frequency reaches the lower limit frequency of the traverse frequency. This value is relative to the percentage of wobble frequency amplitude (07.11).

If set to 0.0%, there is no sudden jump frequency.

07.13	Swing frequency rise time	
	0.1~3600.0s	5.0
07.14	Pendulum frequency falling time	
	0.1~3600.0s	5.0
07.15	Frequency delay of swing frequency upper limit	
	0.1~3600.0s	5.0
07.16	Frequency delay of swing frequency lower limit	
	0.1~3600.0s	5.0

This function code defines the running time from the lower limit frequency of the swing frequency to the upper limit frequency of the swing frequency during swing frequency operation, and the running time and delay from the upper limit frequency of the swing frequency reaching the lower limit frequency of the swing frequency during swing frequency operation.

Swing frequency control is suitable for textile, chemical fiber and other industries and occasions that require traverse and winding functions. Its typical work is shown in Figure 07-2. Usually the swing frequency process is as follows: first accelerate the center frequency of the swing frequency according to the acceleration time, and then press the set swing frequency amplitude (07.11), sudden jump frequency (07.12), swing frequency rise time (07.13) and swing frequency fall time (07.14)) Circulate running until there is a stop command to decelerate and stop according to the deceleration time.

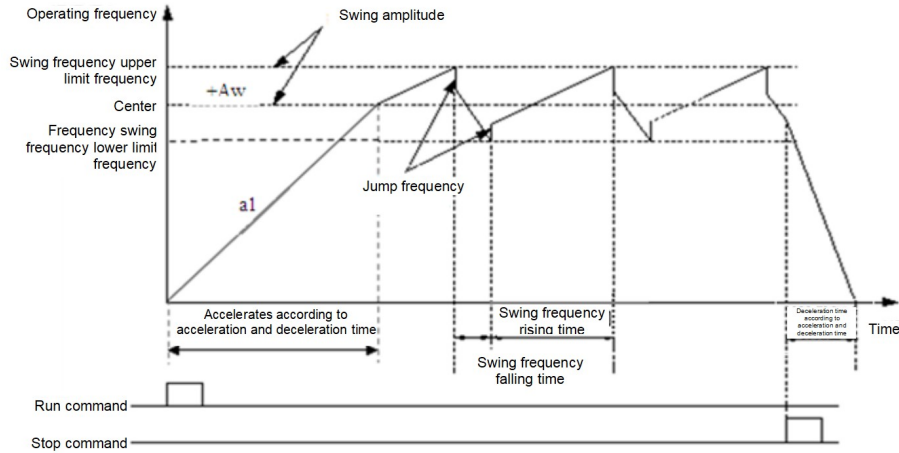

Figure 07-2 Schematic diagram of swing frequency

Group 08-manage and display parameters

08.00	Main parameter monitoring during operation	
	0~30	0

For example: 08.00=2, that is, select the output voltage (D-02), then the default display item on the main monitoring interface is the current output voltage value.

08.01	Main parameter monitoring during stop	
	0~30	1

For example: 08.01=3, that is, bus voltage (d-03) is selected, then the default display item of the main monitoring interface is the current bus voltage value.

08.02	Auxiliary parameter display during operation (only valid for dual display keypad)	
	0~30	4
08.03	Auxiliary parameter display during stop (only valid for dual display keypad)	
	0~30	3

Same as [08.00] and [08.01] parameters!

08.04	Motor speed display coefficient	
	0.01~99.99	1.00

It is used to correct the display error of speed scale, and has no influence on the actual speed.

08.05	Initialization of the parameter	
	0~2	0

0: No-operation

The inverter is in normal parameter reading and writing state. Set value of function code whether it can be changed depends on the setting state of the user password and the current working state of the inverter.

1: Restore the factory settings

All user parameters are restored to the factory settings according to the model.

2: Clear fault record

Clear the contents of fault records (d-19~d-24). After the operation is completed, this function code is cleared to 0 automatically.

08.06	FUNC key settings	
	0~3	0

0: JOG

1: FWD and REV switch

2: Clear ▲/▼ key frequency setting

3: REV (at this time, the RUN key defaults to FWD)

Appendix: Braking resistor selection:

When the drive is decelerating with a large inertia load or needs to be decelerated rapidly, the motor will be in the state of generating electricity, and the load energy will be transferred to the DC link of the drive through the inverter bridge, causing the bus voltage of the drive to rise. When it exceeds a certain value, the drive will report. Voltage failure, in order to prevent the occurrence of this phenomenon, it is recommended to configure a braking resistor.

Notice:

1. Please select the resistance and power of the braking resistor according to the data provided by our company.
2. The braking resistor will increase the braking torque of the drive. The following table is the resistance power designed according to 100% braking torque, 10% braking utilization rate, 50% braking utilization rate, and 80% braking utilization rate. , The user can choose the brake system according to the specific working conditions.

Model	Braking resistance value (Ω) (100% braking torque)	Braking resistor power (kW) (10% braking capacity)	Braking resistor power (kW) (50% braking capacity)	Braking resistor power (kW) (80% braking capacity)	Minimum allowable braking resistance (Ω)
HV10-R40G1-1	361	0.06	0.3	0.48	100
HV10-R75G1-1	192	0.11	0.56	0.9	100
HV10-1R5G1-1	96	0.23	1.1	1.8	60
HV10-2R2G1-1	65	0.33	1.7	2.6	40
HV10-R40G1-2/G2	361	0.06	0.3	0.48	100
HV10-R75G1-2/G2	192	0.11	0.56	0.9	100
HV10-1R5G1-2/G2	96	0.23	1.1	1.8	60
HV10-2R2G1-2/G2	65	0.33	1.7	2.6	40
HV10-R75G3	653	0.11	0.6	0.9	240
HV10-1R5G3	326	0.23	1.1	1.8	170
HV10-2R2G3	222	0.33	1.7	2.6	130
HV10-004G3	122	0.6	3	4.8	80
HV10-5R5G3	89	0.75	4.1	6.6	60

Warranty agreement

- 1 The warranty period of this product is 18 months (subject to the information of fuselage bar code). During the warranty period, if the product breaks down or is damaged under normal use according to the instruction manual, our company is responsible for free maintenance.
- 2 During the warranty period, if the damage is caused by the following reasons, a certain maintenance fee will be charged:
 - A. machine damage caused by errors in use and self-repair or modification without authorization;
 - B. machine damage caused by fire, flood, abnormal voltage, other natural disasters and secondary disasters;
 - C. hardware damage caused by man-made falling and transportation after purchase;
 - D. machine damage caused by not operating in accordance with the user's manual provided by our company;
 - E failures and damages caused by obstacles other than machines (e.g. external equipment factors);
- 3 In case of product failure or damage, please fill in the contents of Product Warranty Card correctly and in detail.
4. The collection of maintenance fees shall be subject to the maintenance price list newly adjusted by our company.
- 5 This warranty card will not be reissued under normal circumstances. Please keep this card and show it to maintenance personnel during warranty.
6. If there is any problem in the service process, please contact our agent or our company in time.

Edition: V8.2

Thanks for choosing HNC product.

Any technique support, please feel free to contact our support team

Tel: 86(20)84898493 Fax: 86(20)61082610

URL: www.hncelectric.com

Email: support@hncelectric.com

