



JG SREIES-REFLECTOR



Product Breakdown Diagram





PARAMETERS

Name	Model	Watt	Chip	Size(mm)	Cutout	Color	Beam Angle
JG SREIES REFLECTOR	JG-75	7-10W	1304/020/1507	186*55	75	WH+BK	24°/38°/55°

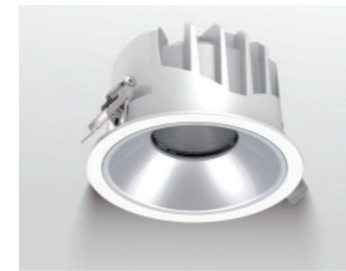
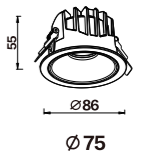

PARAMETERS

Name	Model	Watt	Chip	Size(mm)	Cutout	Color	Beam Angle
JG SREIES REFLECTOR	JG-90	15-18W	1507/020/CXM-9	186*55	75	WH+BK	24°/38°/55°

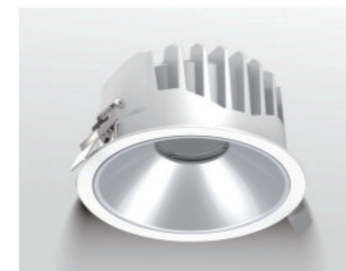
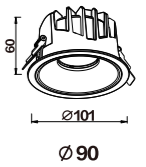

PARAMETERS

Name	Model	Watt	Chip	Size(mm)	Cutout	Color	Beam Angle
JG SREIES REFLECTOR	JG-125	25-30W	1814/030/1507/020	140*73	125	WH+BK	24°/38°/55°

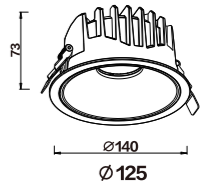

PARAMETERS

Name	Model	Watt	Chip	Size(mm)	Cutout	Color	Beam Angle
JG SREIES REFLECTOR	JG-165	35-40W	1820/2520/030	180*94	165	WH+BK	24°/38°/55°

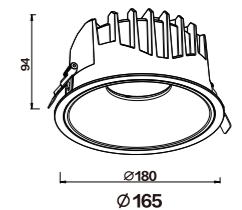

PARAMETERS

Name	Model	Watt	Chip	Size(mm)	Cutout	Color	Beam Angle
JG SREIES REFLECTOR	JG-200	50-55W	1820/2520/030	214*110	200	WH+BK	24°/38°/55°

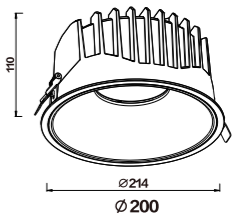

Details

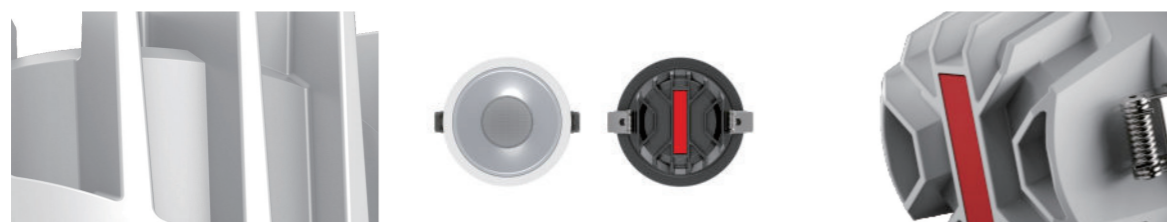



JG SERIES-LENS

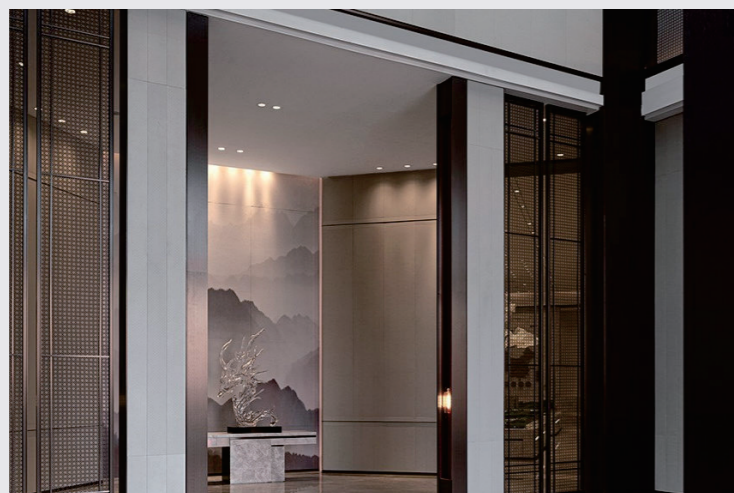

Product Breakdown Diagram



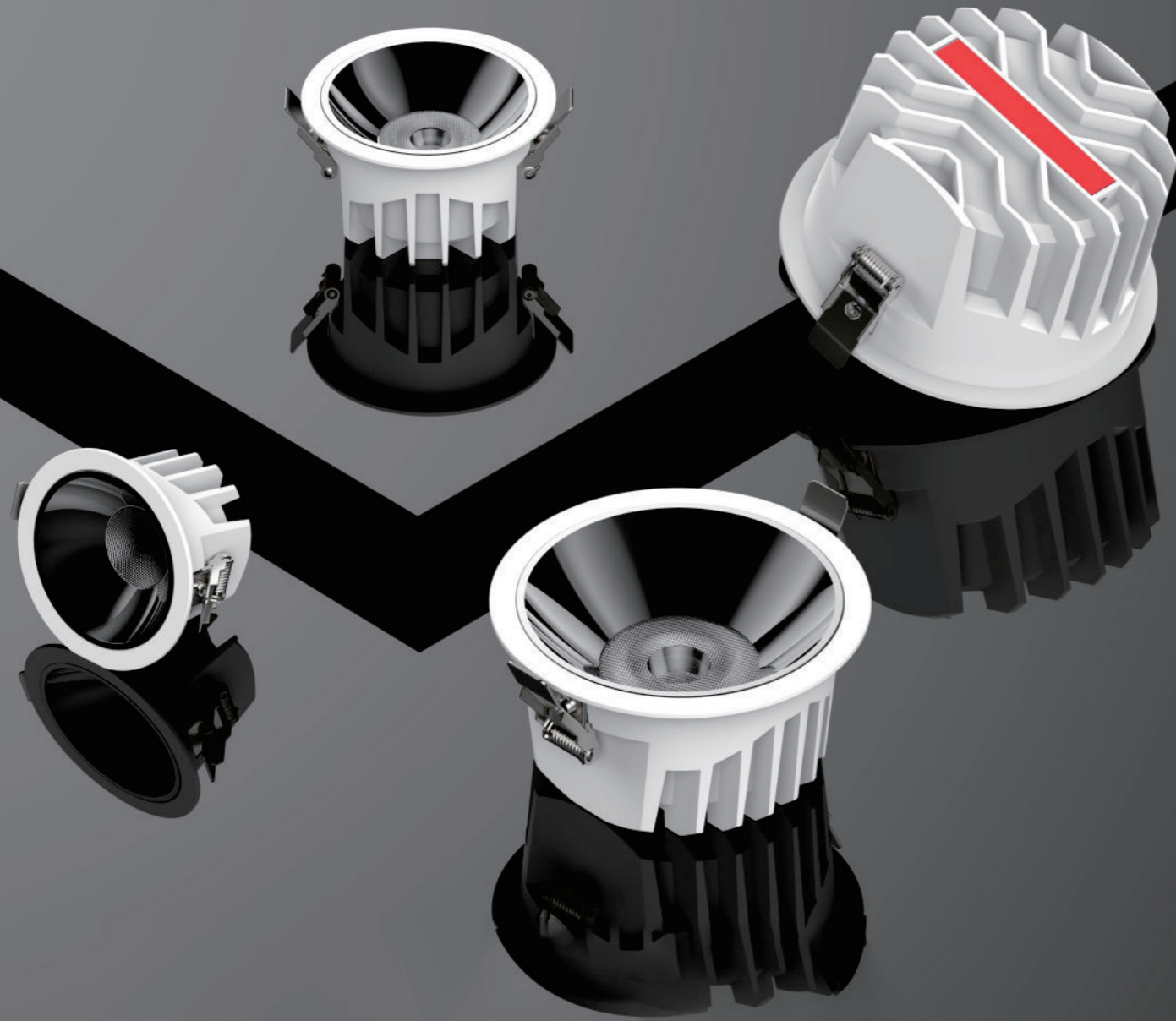

Details

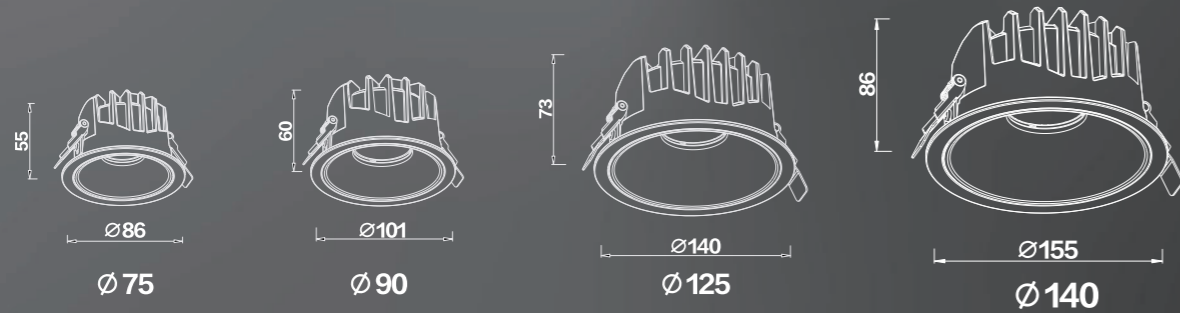

PARAMETERS

Name	Model	Watt	Chip	Size(mm)	Cutout	Color	Beam Angle
JG SREIES-LENS	JG-75	7-10W	1304/020/1507	86*55	75	WH+BK	15°/24°/38°/55°

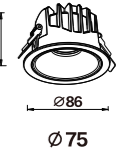

PARAMETERS

Name	Model	Watt	Chip	Size(mm)	Cutout	Color	Beam Angle
JG SREIES-LENS	JG-90	15-18W	1507/020/CXM-9	101*55	75	WH+BK	15°/24°/38°/55°

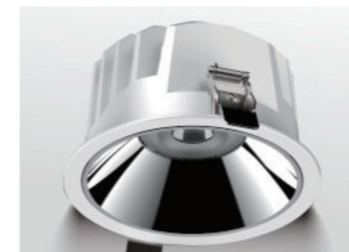
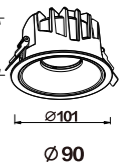

PARAMETERS

Name	Model	Watt	Chip	Size(mm)	Cutout	Color	Beam Angle
JG SREIES-LENS	JG-125	25-30W	1814/030/1507/020	140*73	125	WH+BK	15°/24°/38°/55°

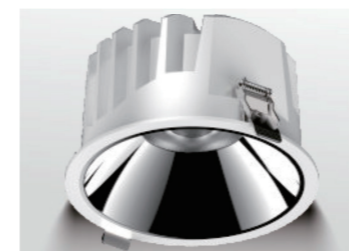
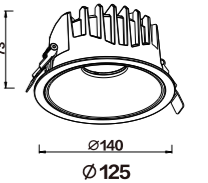

PARAMETERS

Name	Model	Watt	Chip	Size(mm)	Cutout	Color	Beam Angle
JG SREIES-LENS	JG-140	30-35W	1816/030/1507/020	155*86	140	WH+BK	15°/24°/38°/55°

