

THINKING AND ORIGINAL DESIGN

[www.hyeelighting.com](http://www.hyeelighting.com)



**Zhongshan Huiyi Lighting Technology Co., Ltd**

M: 0760-22239223 13826419103

E: [hy@hyeelighting.com](mailto:hy@hyeelighting.com)

A: No. 8, South 1st Street, Lianfeng Xingfu 2nd Road, Xiaolan, Zhongshan





## ■ About US

Huiyi Lighting Technology Co., Ltd, is a supplier of high-quality commercial lighting kits. With novel product design styles and high-level professional service capabilities as the core, independent research and development and in-depth oriented development as the guide, it has constantly studied and learned the international cutting-edge product design styles and concepts, combined with contemporary domestic and international lighting market trends, advocates innovation and is keen to try. It has successively developed many high-end business lighting benchmark products. With the company's increasingly strong research and development capabilities and specialized solution output, Huiyi lighting has quickly become a new benchmark in the industry and a strategic partner for many brand businesses.







Creating greater business value for our customers is our most steadfast direction.  
Providing customers with the best supporting services is our ultimate pursuit.  
We have been working hard until forever.



# INDEX

...











## DOWNLIGHT

17-30	JS SERIES	
71-96	BL SERIES-SMD	
85-90	BL SERIES-COB	
83-84	LD SERIES	
109-112	JG SERIES-LENS	
105-109	JG SREIES-REFLECTOR	

## SURFACE MOUNTED

67-70	BLM SERIES-SMD	
63-66	BLM SERIES-COB	
101-104	MZD SERIES	

## SPOT LIGHT

41-46	HR SERIES		05-08	TY SERIES	
47-50	TM SERIES		09-16	JK SERIES	
51-54	TG SERIES		31-32	XLT SERIES	
55-62	QTZ SERIES		23-34	ALT SERIES	
71-82	DHF SERIES		35-40	MR16 MODULE	
97-100	MS SERIES				

# TY SERIES



## Product Breakdown Diagram

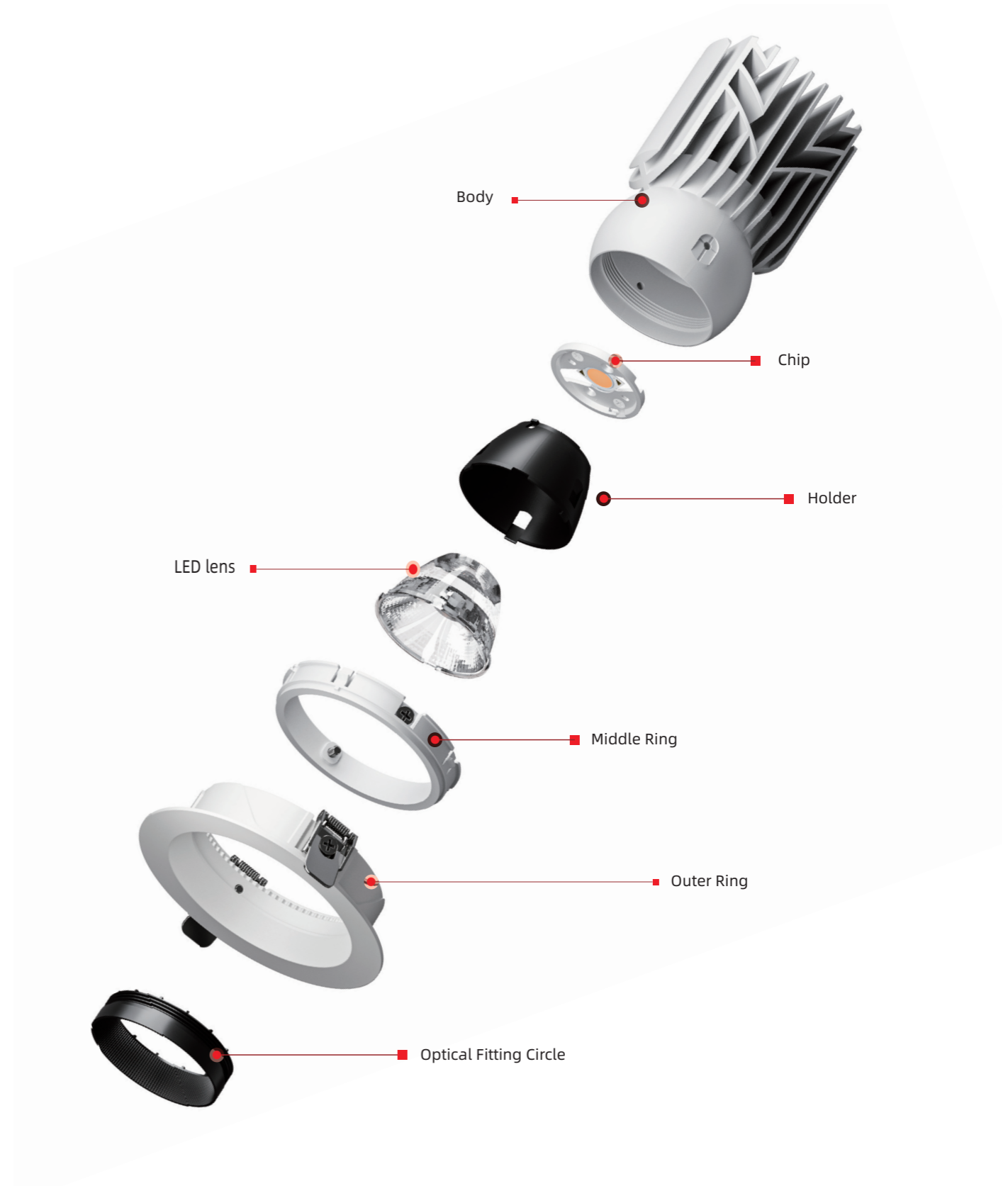



**PARAMETERS**

Name	Model	Watt	Chip	Size(mm)	Cutout	Beam Angle
TY SERIES	TY-75R	20W	020/1304/1507	90*109	Ø 75	15°24°36°50°

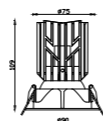

**PARAMETERS**

Name	Model	Watt	Chip	Size(mm)	Cutout	Beam Angle
TY SERIES	TY-75S	20W	020/1304/1507	90*90*109	Ø 75*75	15°24°36°50°

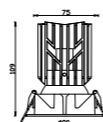

**PARAMETERS**

Name	Model	Watt	Chip	Size(mm)	Cutout	Beam Angle
TY SERIES	TY-75D	20W*2	020/1304/1507	90*169*109	Ø 150*75	15°24°36°50°

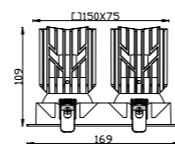

**PARAMETERS**

Name	Model	Watt	Chip	Size(mm)	Cutout	Beam Angle
TY SERIES	TY-95R	30-35W	020/1507/1816	115*125	Ø 95	15°24°36°50°

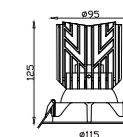

**PARAMETERS**

Name	Model	Watt	Chip	Size(mm)	Cutout	Beam Angle
TY SERIES	TY-95S	30-35W	020/1507/1816	115*115*125	Ø 95*95	15°24°36°50°

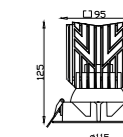

**PARAMETERS**

Name	Model	Watt	Chip	Size(mm)	Cutout	Beam Angle
TY SERIES	TY-95SD	(30-35W) *2	020/1507/1816	115*216*125	Ø 193*95	15°24°36°50°

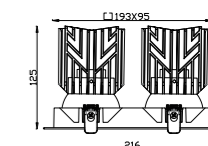

**PARAMETERS**

Name	Model	Watt	Chip	Size(mm)	Cutout	Beam Angle
TY SERIES	TY-115R	40-45W	030/1816	130*140	Ø 115	15°24°36°50°

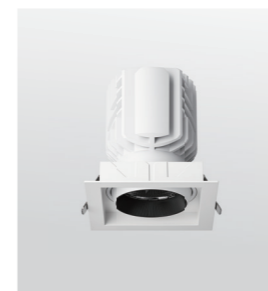
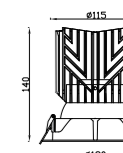

**PARAMETERS**

Name	Model	Watt	Chip	Size(mm)	Cutout	Beam Angle
TY SERIES	TY-115S	40-45W	030/1816	130*130*140	Ø 115*115	15°24°36°50°

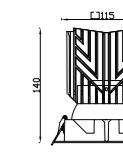

**PARAMETERS**

Name	Model	Watt	Chip	Size(mm)	Cutout	Beam Angle
TY SERIES	TY-115SD	(40-45W) *2	030/1816	130*245*140	Ø 220*115	15°24°36°50°

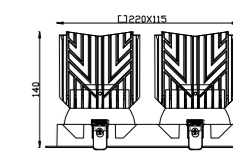

# JK SERIES

High Power | High Lumens | Deep Anti-glare

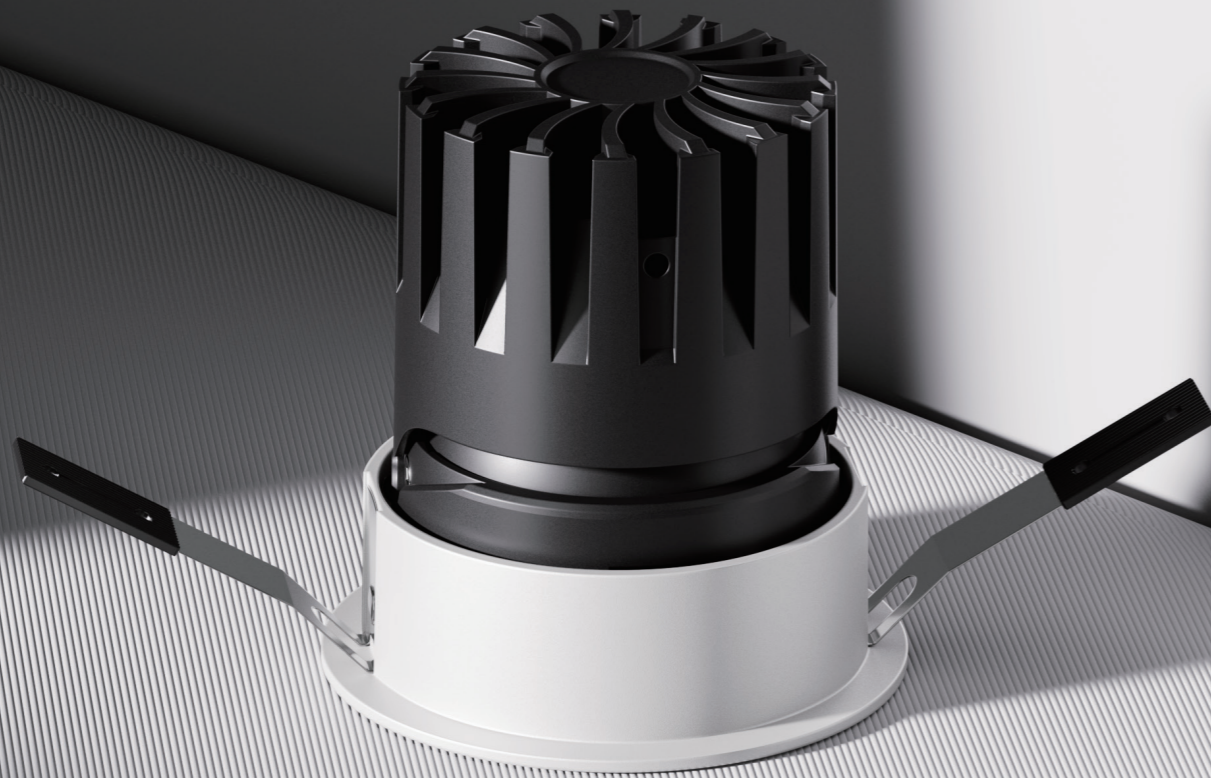

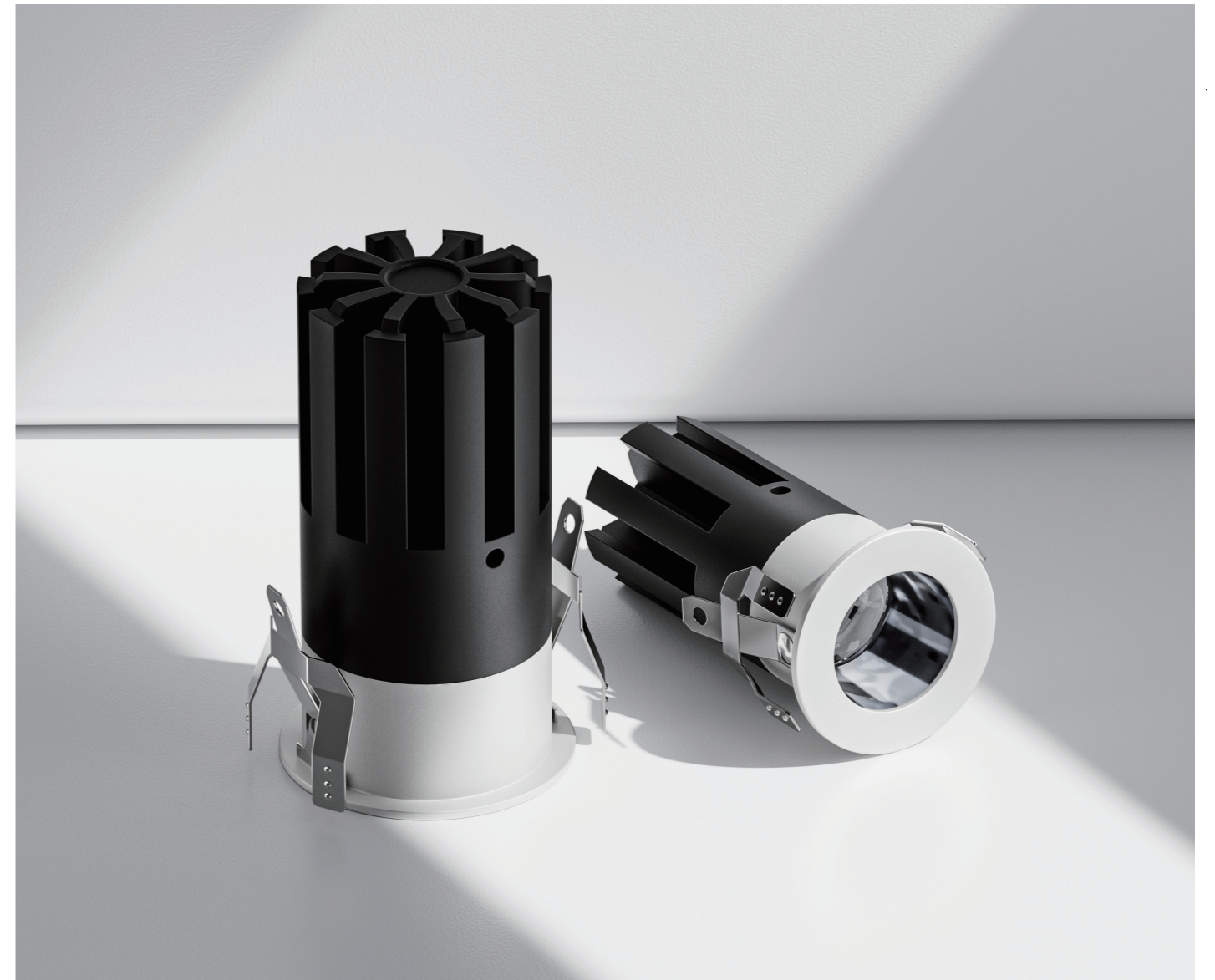

**PARAMETERS**

Name	Model	Watt	Chip	Size(mm)	Cutout(mm)	Beam Angle
JK SERIES	JK-35R	7W	1304	40*76.5	Ø 35	15°24°36°50°

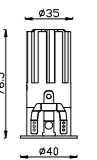

**PARAMETERS**

Name	Model	Watt	Chip	Size(mm)	Cutout(mm)	Beam Angle
JK SERIES	JK-45R	10W	1304	50*88.5	Ø 45	15°24°36°50°

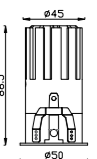



**PARAMETERS**

Name	Model	Watt	Chip	Size(mm)	Color	Beam Angle
JK SERIES	JK -55R	10-12W	020/1304/1507	62*106.5	WH+BK	15°24°36°50°

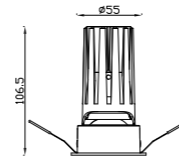

**PARAMETERS**

Name	Model	Watt	Chip	Size(mm)	Color	Beam Angle
JK SERIES	JK -55RT	10-12W	020/1304/1507	70*106.5	WH+BK	15°24°36°50°

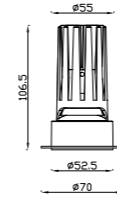

**PARAMETERS**

Name	Model	Watt	Chip	Size(mm)	Color	Beam Angle
JK SERIES	JK -55S	10-12W	020/1304/1507	62*62*106.5	WH+BK	15°24°36°50°

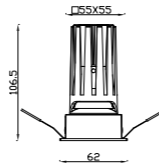

**PARAMETERS**

Name	Model	Watt	Chip	Size(mm)	Color	Beam Angle
JK SERIES	JK -55ST	10-12W	020/1304/1507	70*70*106.5	WH+BK	15°24°36°50°

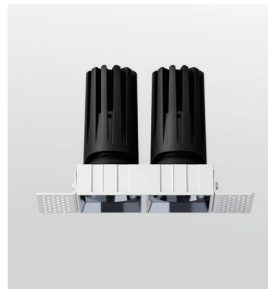
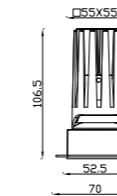

**PARAMETERS**

Name	Model	Watt	Chip	Size(mm)	Color	Beam Angle
JK SERIES	JK -55SD	(10-12W) *2	020/1304/1507	115.5*62*106.5	WH+BK	15°24°36°50°

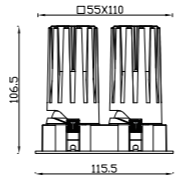

**PARAMETERS**

Name	Model	Watt	Chip	Size(mm)	Color	Beam Angle
JK SERIES	JK -55SDT	(10-12W) *2	020/1304/1507	164.5*52*106.5	WH+BK	15°24°36°50°

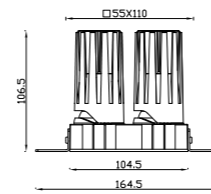

**PARAMETERS**

Name	Model	Watt	Chip	Size(mm)	Color	Beam Angle
JK SERIES	JK -75R-15W	10-12W	020/1304/1507	82*88.2	WH+BK	15°24°36°50°

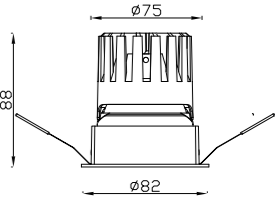

**PARAMETERS**

Name	Model	Watt	Chip	Size(mm)	Color	Beam Angle
JK SERIES	JK -75RT-15W	10-12W	020/1304/1507	95*87.5	WH+BK	15°24°36°50°

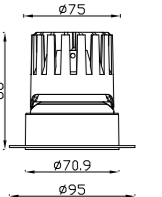

**PARAMETERS**

Name	Model	Watt	Chip	Size(mm)	Color	Beam Angle
JK SERIES	JK -75S-15W	10-12W	020/1304/1507	82*82*87.5	WH+BK	15°24°36°50°

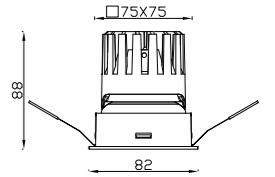

**PARAMETERS**

Name	Model	Watt	Chip	Size(mm)	Color	Beam Angle
JK SERIES	JK -75ST-15W	10-12W	020/1304/1507	98*98*87.5	WH+BK	15°24°36°50°

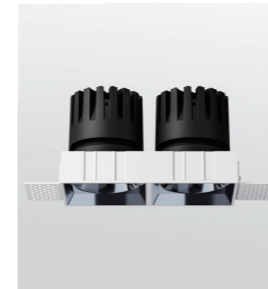
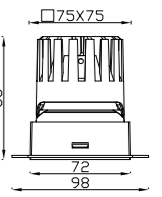

**PARAMETERS**

Name	Model	Watt	Chip	Size(mm)	Color	Beam Angle
JK SERIES	JK -75SD-15W	(10-12W) *2	020/1304/1507	158*86*87.5	WH+BK	15°24°36°50°

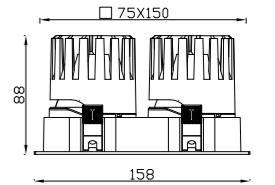

**PARAMETERS**

Name	Model	Watt	Chip	Size(mm)	Color	Beam Angle
JK SERIES	JK -75SDT-15W	(10-12W) *2	020/1304/1507	204.5*72*87.5	WH+BK	15°24°36°50°

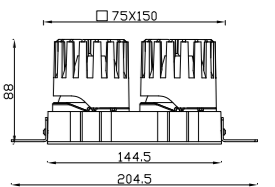





**PARAMETERS**

Name	Model	Watt	Chip	Size(mm)	Color	Beam Angle
JK SERIES	JK -75R-20W	15-20W	020/1304/1507	82*115	WH+BK	15°24°36°50°

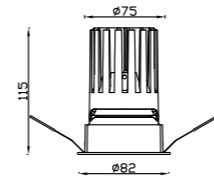

**PARAMETERS**

Name	Model	Watt	Chip	Size(mm)	Color	Beam Angle
JK SERIES	JK -75RT-20W	15-20W	020/1304/1507	95*115	WH+BK	15°24°36°50°

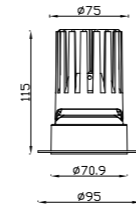

**PARAMETERS**

Name	Model	Watt	Chip	Size(mm)	Color	Beam Angle
JK SERIES	JK -75S-20W	15-20W	020/1304/1507	82*82*115	WH+BK	15°24°36°50°

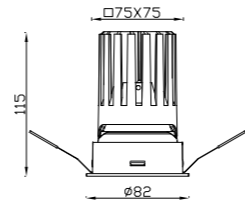

**PARAMETERS**

Name	Model	Watt	Chip	Size(mm)	Color	Beam Angle
JK SERIES	JK -75ST-20W	15-20W	020/1304/1507	98*98*115	WH+BK	15°24°36°50°

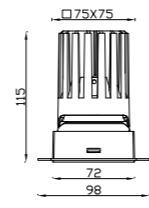

**PARAMETERS**

Name	Model	Watt	Chip	Size(mm)	Color	Beam Angle
JK SERIES	JK -75SD-20W	(15-20W) *2	020/1304/1507	158*86*115	WH+BK	15°24°36°50°

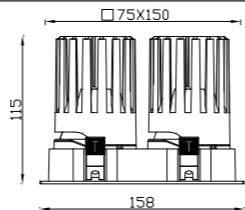

**PARAMETERS**

Name	Model	Watt	Chip	Size(mm)	Color	Beam Angle
JK SERIES	JK -75SDT-20W	(15-20W) *2	020/1304/1507	204.5*72*115	WH+BK	15°24°36°50°

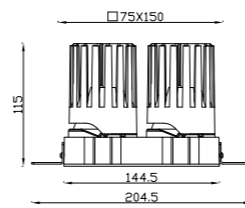

**PARAMETERS**

Name	Model	Watt	Chip	Size(mm)	Color	Beam Angle
JK SERIES	JK -75R-20W	20-30W	020/1304/1507	82*115	WH+BK	15°24°36°50°

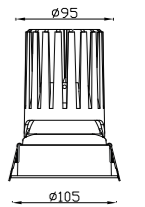

**PARAMETERS**

Name	Model	Watt	Chip	Size(mm)	Color	Beam Angle
JK SERIES	JK -95RT	25-30W	020/1304/1507	120*146	WH+BK	15°24°36°50°

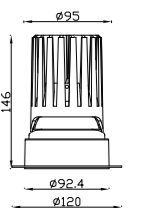

**PARAMETERS**

Name	Model	Watt	Chip	Size(mm)	Color	Beam Angle
JK SERIES	JK -95S	25-30W	020/1304/1507	102.5*102.5*146	WH+BK	15°24°36°50°

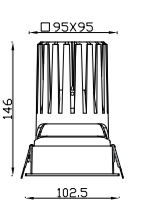

**PARAMETERS**

Name	Model	Watt	Chip	Size(mm)	Color	Beam Angle
JK SERIES	JK -95ST	25-30W	020/1304/1507	120*120*146	WH+BK	15°24°36°50°

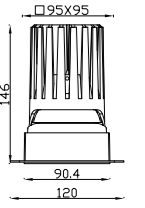

**PARAMETERS**

Name	Model	Watt	Chip	Size(mm)	Color	Beam Angle
JK SERIES	JK -95SD	(25-30W) *2	020/1304/1507	197.5*106.5*146	WH+BK	15°24°36°50°

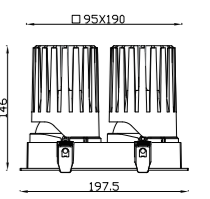

**PARAMETERS**

Name	Model	Watt	Chip	Size(mm)	Color	Beam Angle
JK SERIES	JK -95SDT	(25-30W) *2	020/1304/1507	241.5*90.5*146	WH+BK	15°24°36°50°

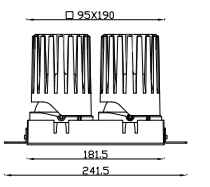

# JAZZ SERIES



Elegant and versatile  
set off the beauty of different spaces

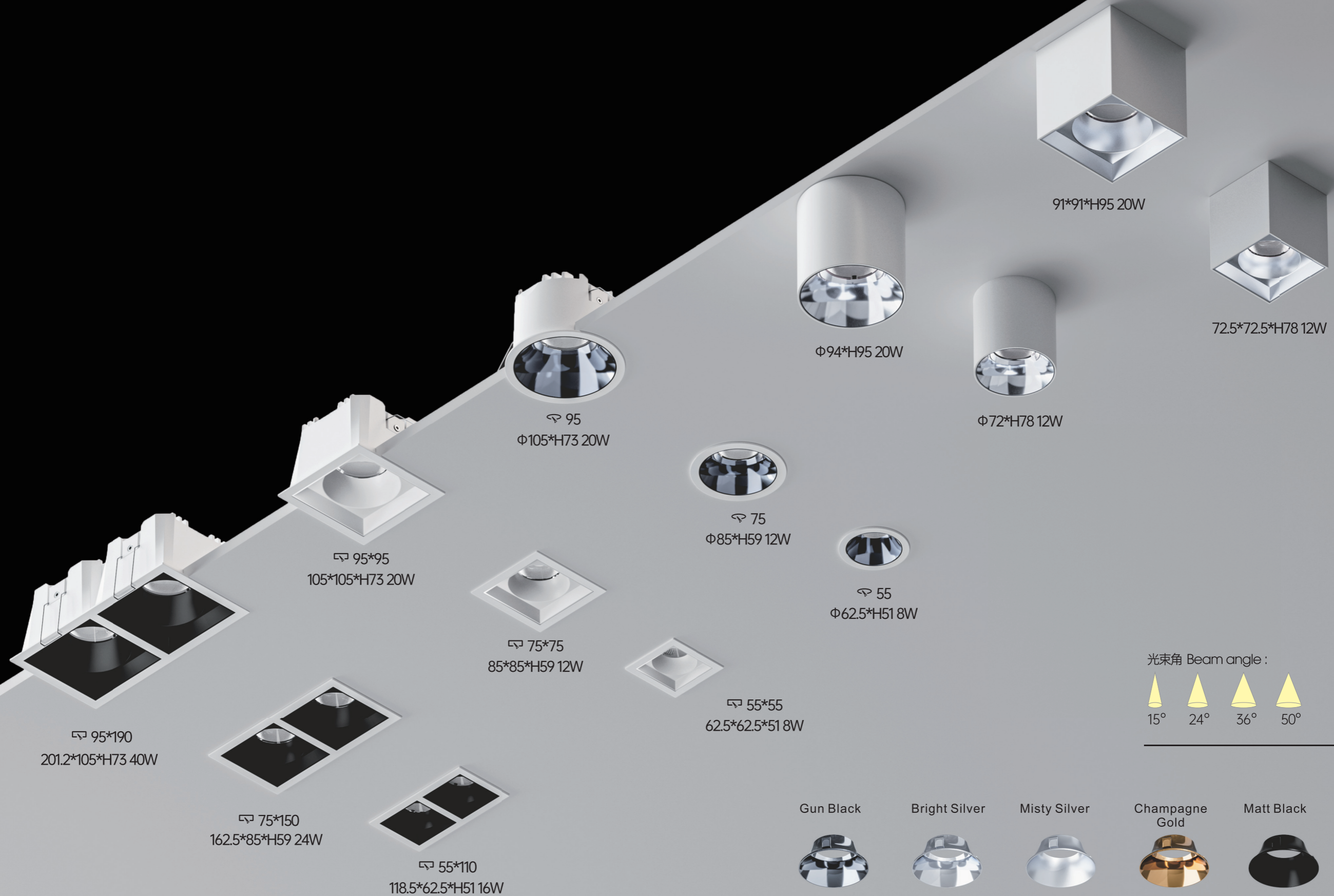



Hidden spring design  
and easy to install

## SPECIAL OPTICAL DESIGN JAZZ SERIES

High luminous output  
Light spot transition is even  
more soft and comfortable

UGR < 8

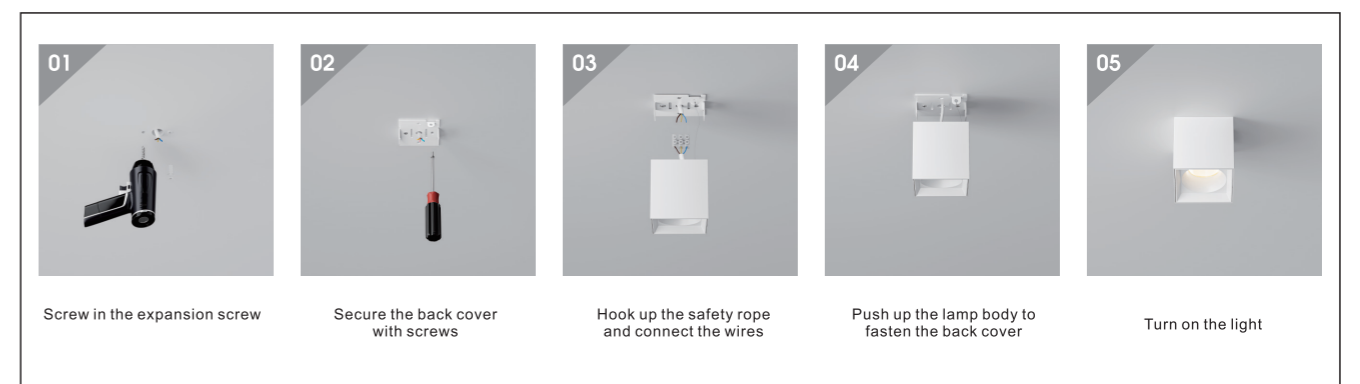
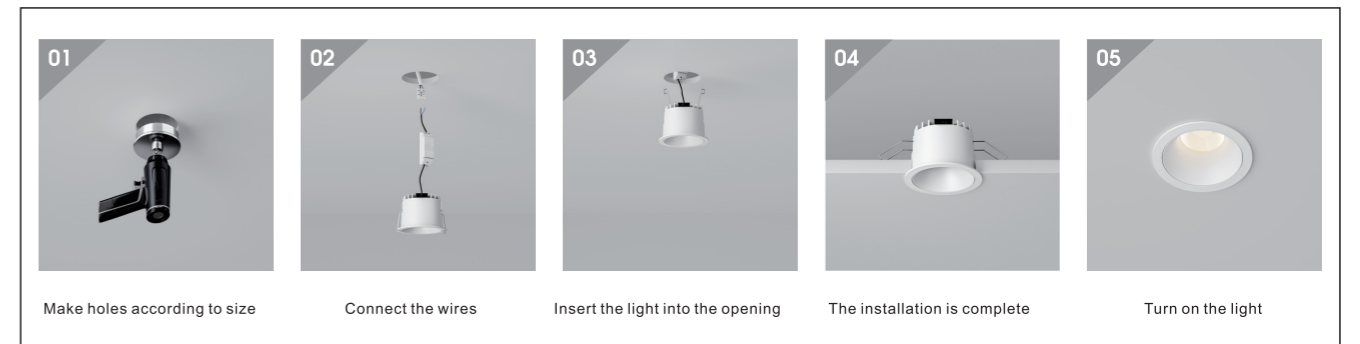
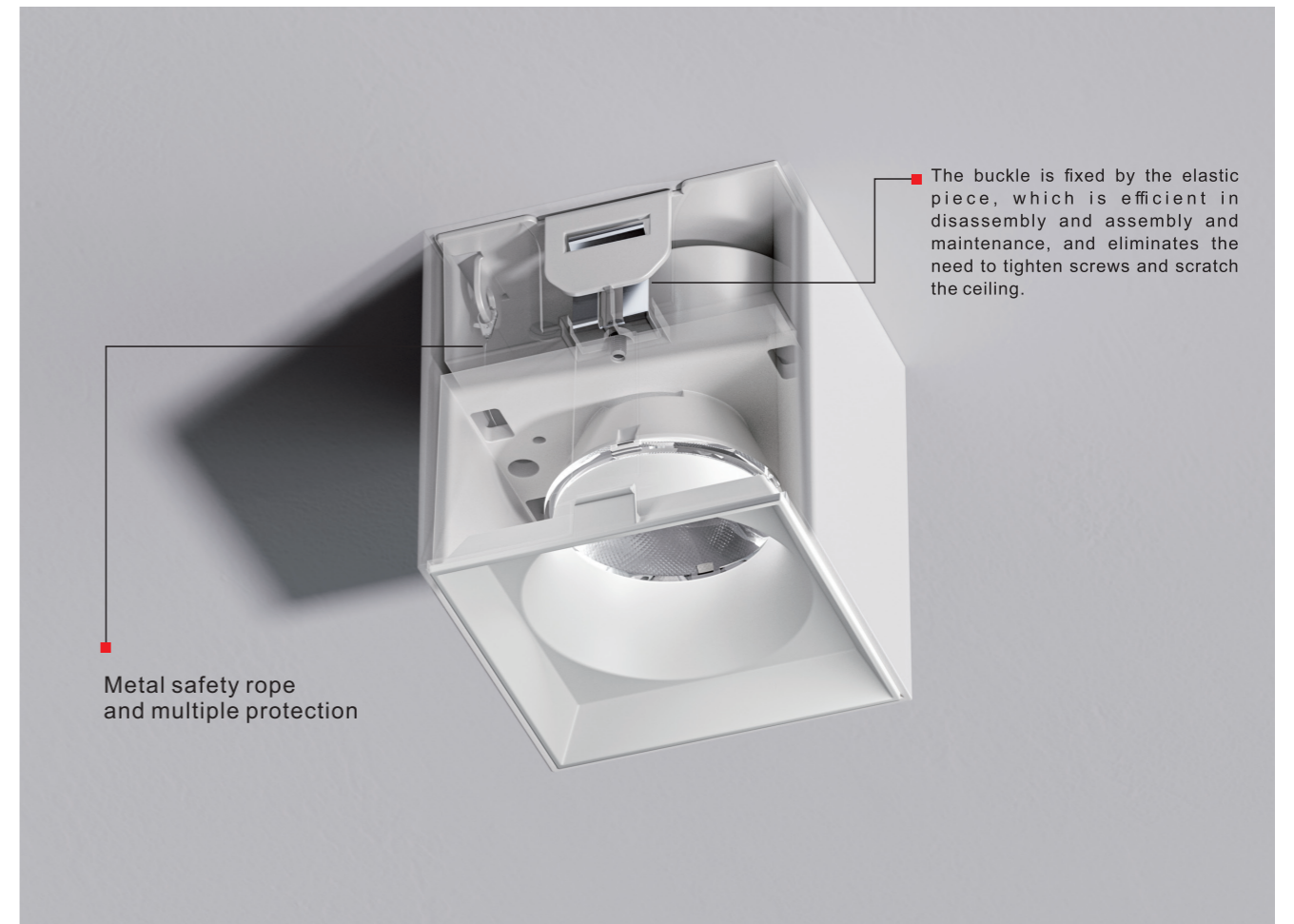
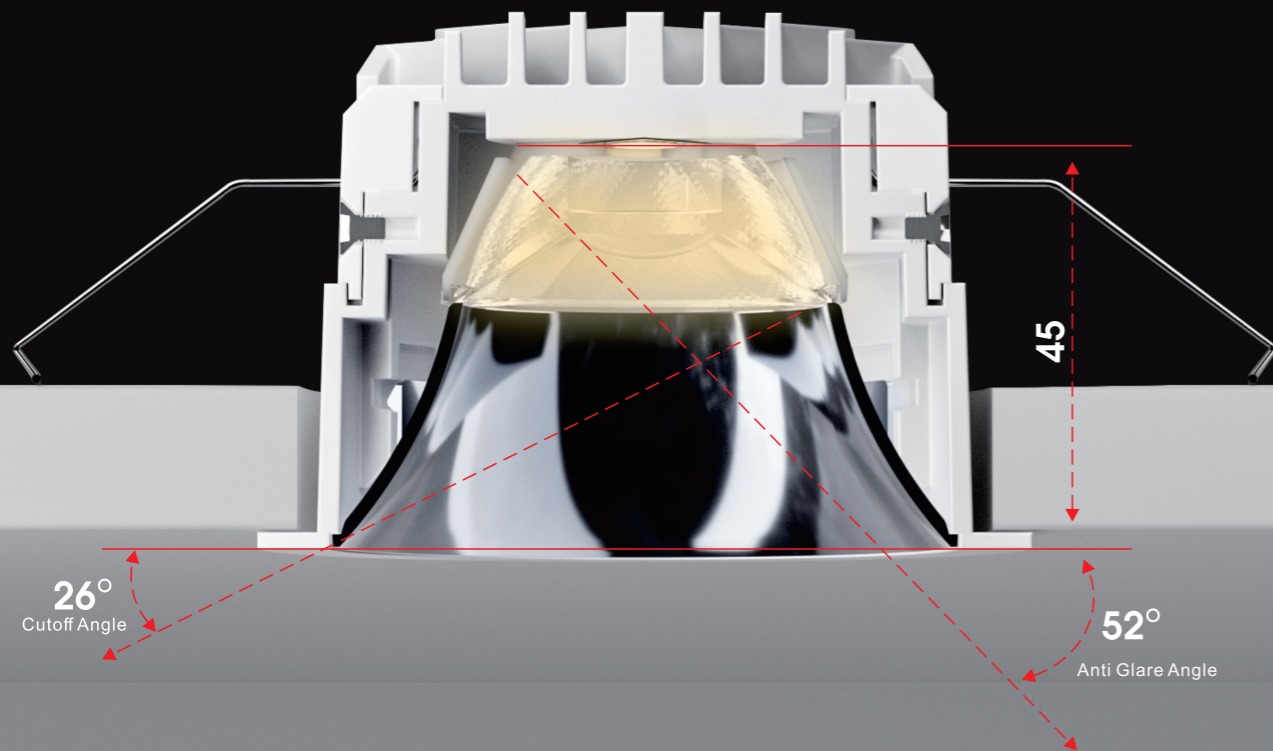

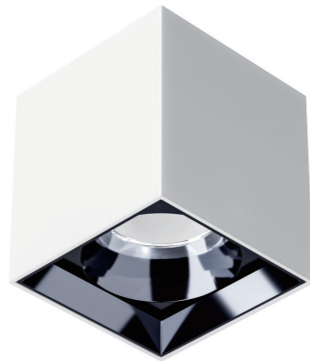

JS-75F-MZ

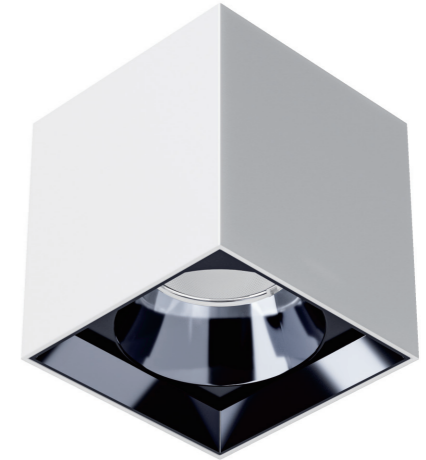

JS-95Y-MZ

JS-95F-MZ

Beam Angle:

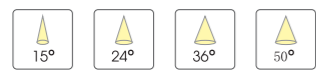

Cup Color:

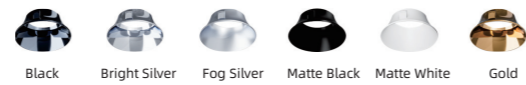

Beam Angle:



Cup Color:

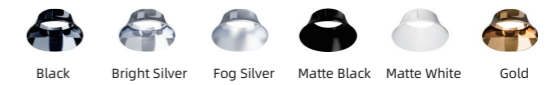

**PARAMETERS**

Name	Model	Watt	Chip	Size(mm)	Beam Angle
JS SERIES	JS -75Y-MZ	12W	020/1304/1507	72*H78	15°24°36°50°

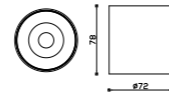

**PARAMETERS**

Name	Model	Watt	Chip	Size(mm)	Beam Angle
JS SERIES	JS -75F-MZ	12W	020/1304/1507	72.5*72.5*H78	15°24°36°50°

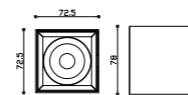

**PARAMETERS**

Name	Model	Watt	Chip	Size(mm)	Beam Angle
JS SERIES	JS -95Y-MZ	20W	020/1304/1507	94*H95	15°24°36°50°

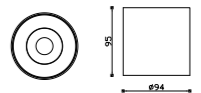

**PARAMETERS**

Name	Model	Watt	Chip	Size(mm)	Beam Angle
JS SERIES	JS -95F-MZ	20W	020/1304/1507	91*91*H95	15°24°36°50°

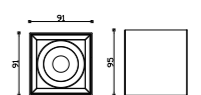



JS-55Y

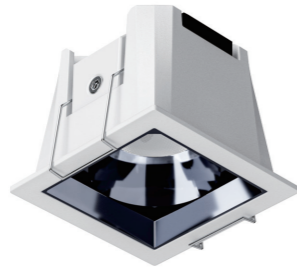

JS-55F

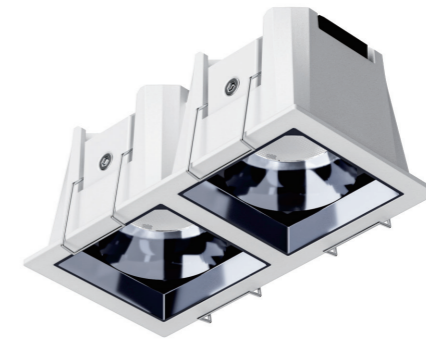

JS-55-2F

Beam Angle:



Cup Color:

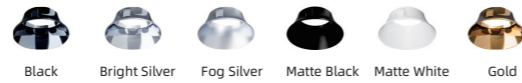

Beam Angle:



Cup Color:



**PARAMETERS**

Name	Model	Watt	Chip	Size(mm)	Beam Angle
JS SERIES	JS -55Y	8W	1304/020	55*62.5*H51	15°24°36°50°

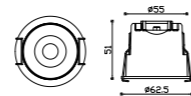

**PARAMETERS**

Name	Model	Watt	Chip	Size(mm)	Beam Angle
JS SERIES	JS -55F	8W	020/1304/1507	62.5*62.5*H51	15°24°36°50°

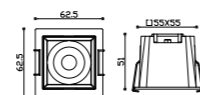

**PARAMETERS**

Name	Model	Watt	Chip	Size(mm)	Beam Angle
JS SERIES	JS -55-2F	16W	020/1816/1507	118.5*62.5*H95	15°24°36°50°

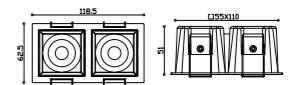



JS-75Y

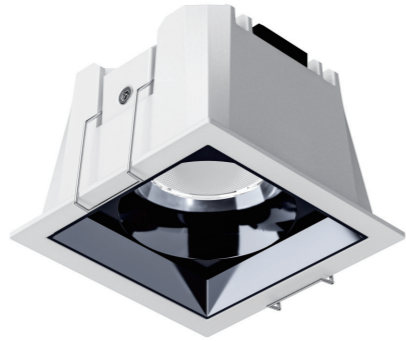

JS-75F

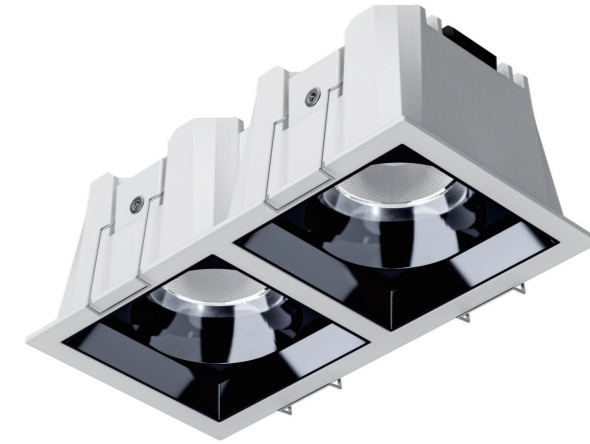

JS-75-2F

Beam Angle:

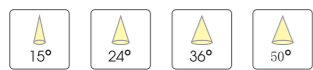

Cup Color:

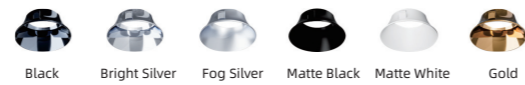

Beam Angle:



Cup Color:

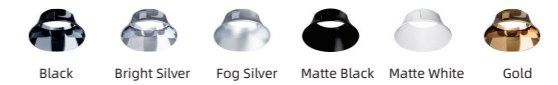

**PARAMETERS**

Name	Model	Watt	Chip	Size(mm)	Beam Angle
JS SERIES	JS -75Y	12W	020/1304/1507	75*85H59	15°24°36°50°

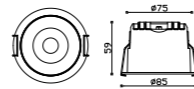

**PARAMETERS**

Name	Model	Watt	Chip	Size(mm)	Beam Angle
JS SERIES	JS -75F	12W	020/1304/1507	85*85H59	15°24°36°50°

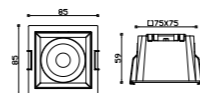

**PARAMETERS**

Name	Model	Watt	Chip	Size(mm)	Beam Angle
JS SERIES	JS -75-2F	24W	020/1816/1507	162.5*85H59	15°24°36°50°

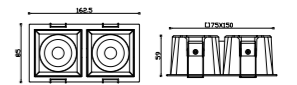



JS-95Y

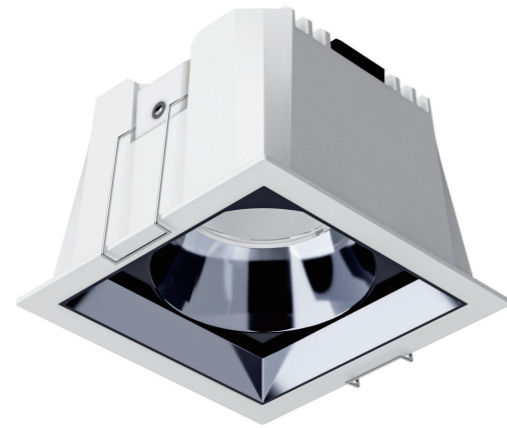

JS-95F



JS-95-2F

Beam Angle:

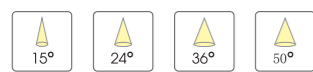

Cup Color:

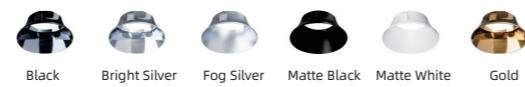

**PARAMETERS**

Name	Model	Watt	Chip	Size(mm)	Beam Angle
JS SERIES	JS-95Y	20W	020/1304/1507	95*H73	15°24°36°50°

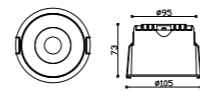

**PARAMETERS**

Name	Model	Watt	Chip	Size(mm)	Beam Angle
JS SERIES	JS-95F	20W	020/1304/1507	105*105*H73	15°24°36°50°

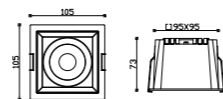

Beam Angle:



Cup Color:

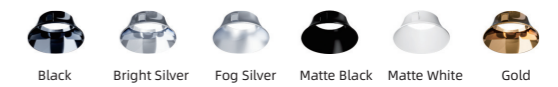

**PARAMETERS**

Name	Model	Watt	Chip	Size(mm)	Beam Angle
JS SERIES	JS-95-2F	40W	020/1816/1507	201.5*105*H73	15°24°36°50°

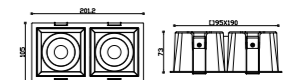



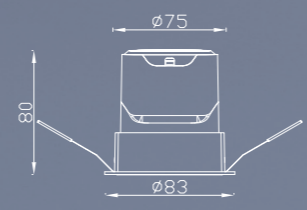
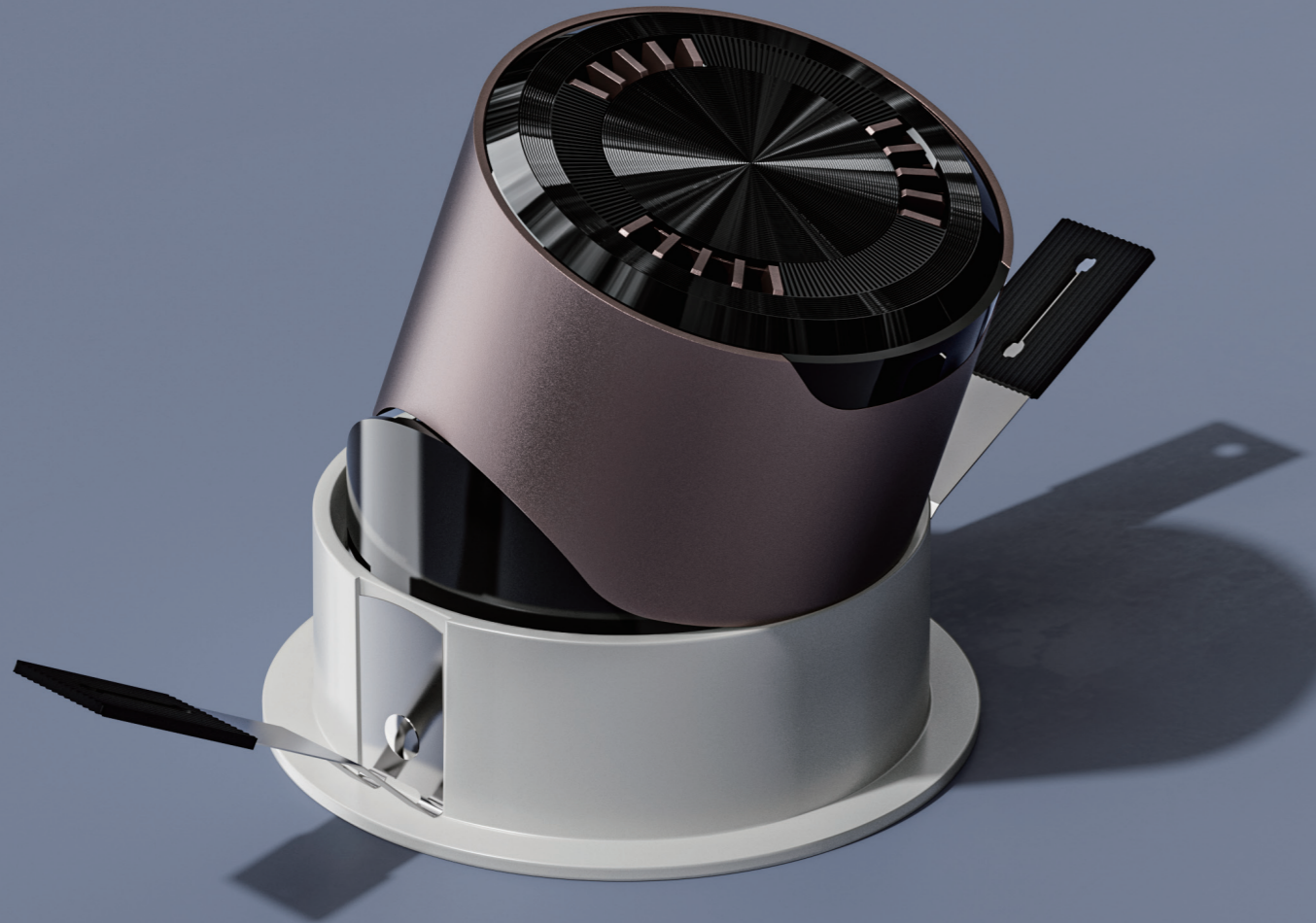

PARAMETERS

Name	Model	Watt	Chip	Size(mm)	Color	Beam Angle
XLT SERIES	XLT-75R	10-12W	020/1304/1507	82*80	Brown+WH	15°24°38°



PARAMETERS

Name	Model	Watt	Chip	Size(mm)	Color	Beam Angle
XLT SERIES	XLT-75RT	10-12W	020/1304/1507	95*80	Brown+WH	15°24°38°



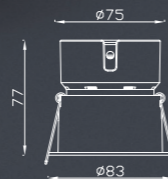
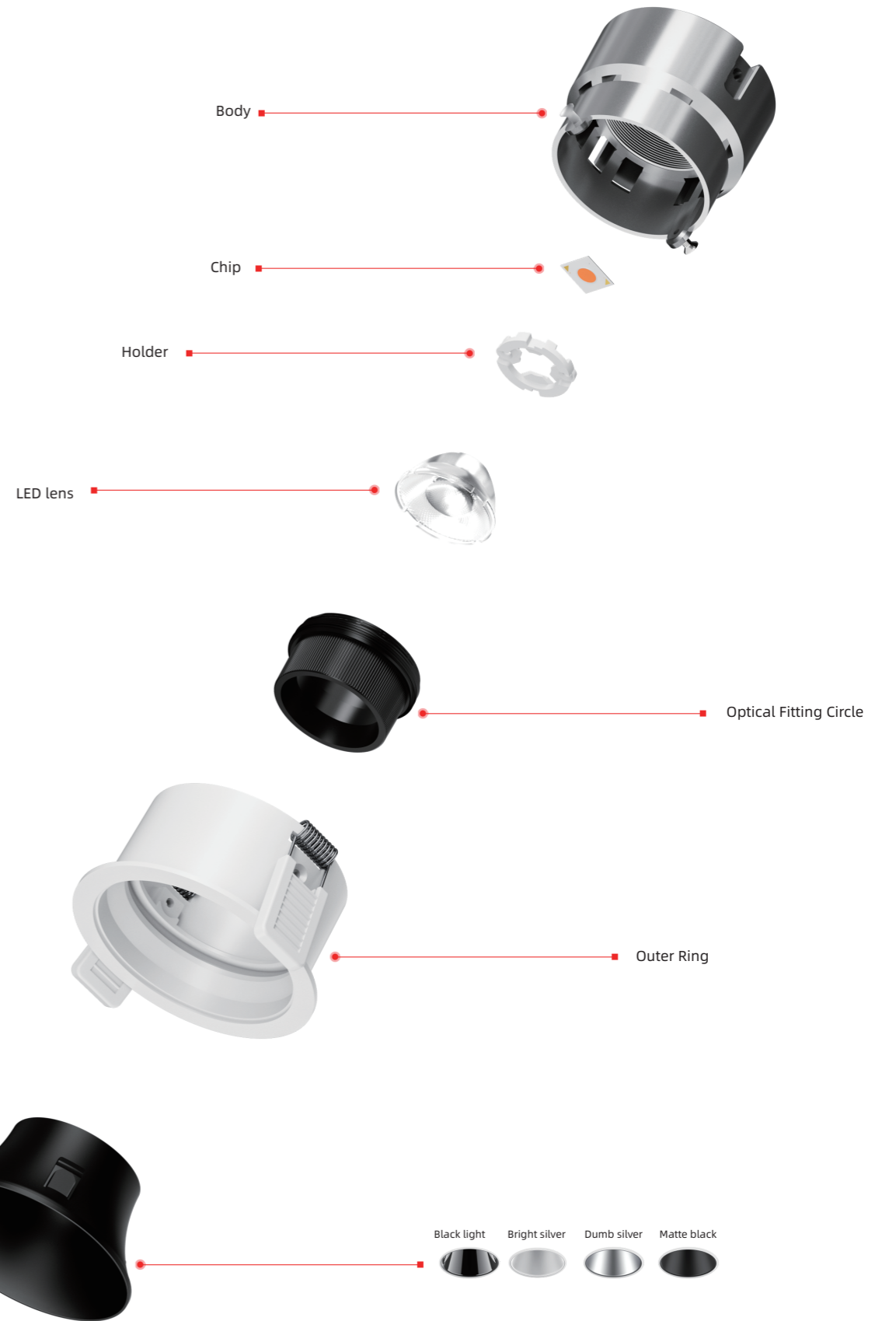

PARAMETERS

Name	Model	Watt	Chip	Size(mm)	Color	Beam Angle
ALT SERIES	ALT-75	10W	020/1304/1507	83*77	Gray+WH	15°24°38°55°



MR16 Module ShootLight



Product Breakdown Diagram

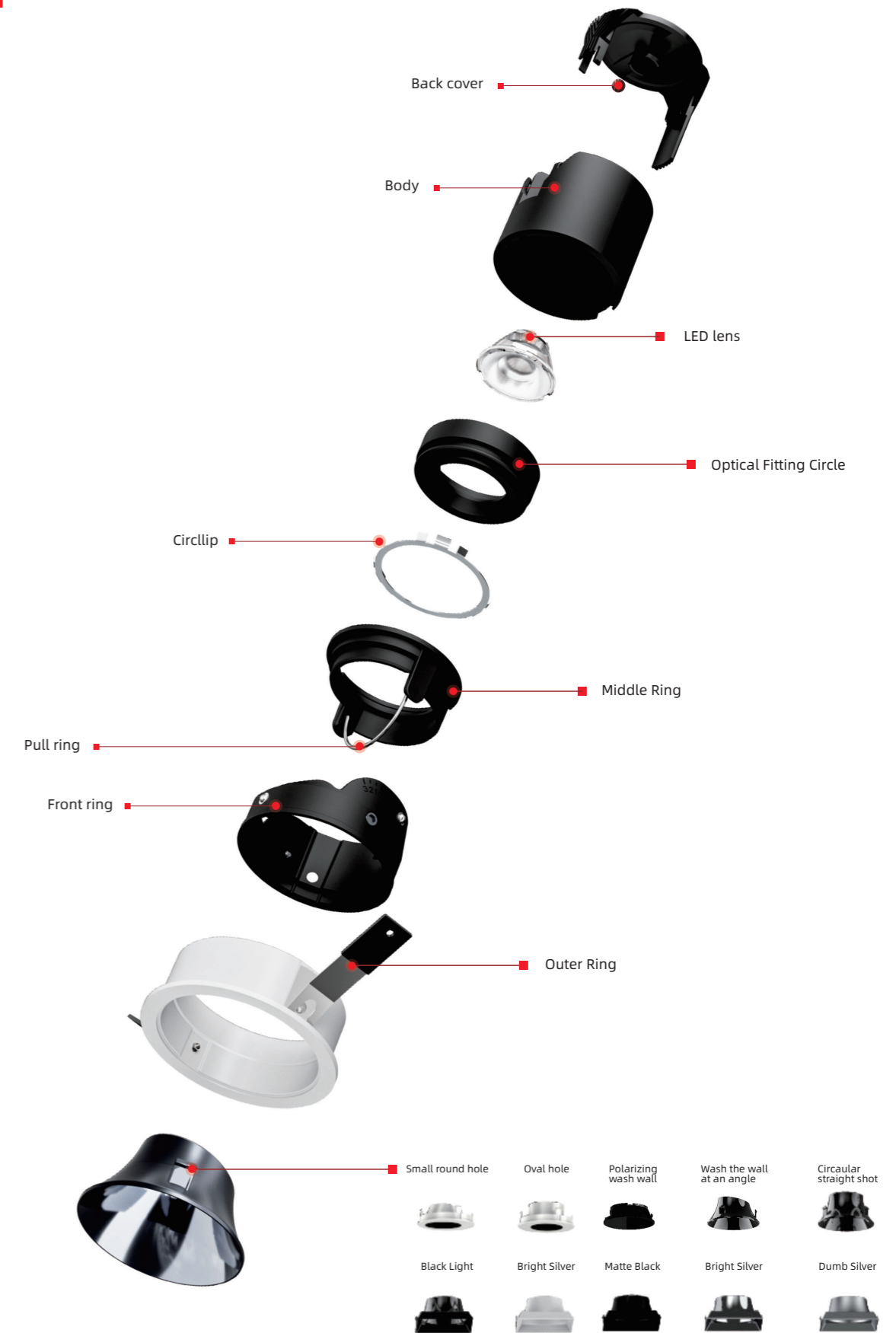

Module Series, More Options



**PARAMETERS**

Name	Model	Size(mm)	Color
MR16 MODULE	MR16 -75R-10W-Ring	82*46.4	WH+BK

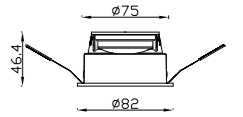

**PARAMETERS**

Name	Model	Size(mm)	Color
MR16 MODULE	MR16 -75RT-10W-Ring	95*46.4	WH+BK

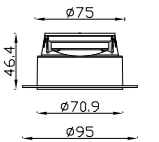

**PARAMETERS**

Name	Model	Size(mm)	Color
MR16 MODULE	MR16 -75S-10W-Ring	82*82*46.4	WH+BK

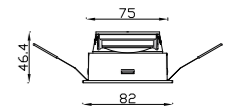

**PARAMETERS**

Name	Model	Size(mm)	Color
MR16 MODULE	MR16 -75ST-10W-Ring	95*95*46.4	WH+BK

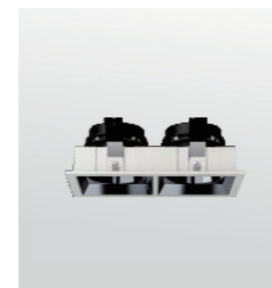
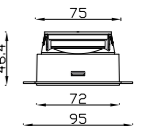

**PARAMETERS**

Name	Model	Size(mm)	Color
MR16 MODULE	MR16 -75SD-10W-Ring	158*86*46.4	WH+BK

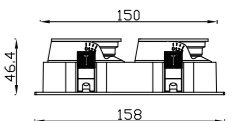

**PARAMETERS**

Name	Model	Size(mm)	Color
MR16 MODULE	MR16 -75SDT-10W-Ring	145*75*46.4	WH+BK

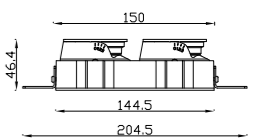



**PARAMETERS**

Name	Model	Watt	Chip	Size(mm)	Color	Beam Angle
MR16 MODULE	MR16 -75R-10W	10W	1304/1507/020	82*94.3	WH+BK	15°24°38°55°

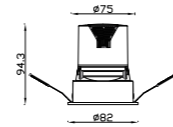

**PARAMETERS**

Name	Model	Watt	Chip	Size(mm)	Color	Beam Angle
MR16 MODULE	MR16 -75R-15W	15W	1304/1507/020	82*105	WH+BK	15°24°38°55°

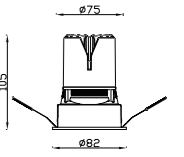

**PARAMETERS**

Name	Model	Watt	Chip	Size(mm)	Color	Beam Angle
MR16 MODULE	MR16 -75RT-10W	10W	1304/1507/020	85*94.3	WH+BK	15°24°38°55°

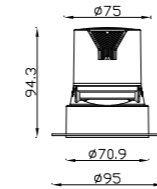

**PARAMETERS**

Name	Model	Watt	Chip	Size(mm)	Color	Beam Angle
MR16 MODULE	MR16 -75RT-15W	15W	1304/1507/020	95*105	WH+BK	15°24°38°55°

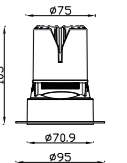

**PARAMETERS**

Name	Model	Watt	Chip	Size(mm)	Color	Beam Angle
MR16 MODULE	MR16 -75S-10W	10W	1304/1507/020	82*82*94.3	WH+BK	15°24°38°55°

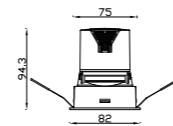

**PARAMETERS**

Name	Model	Watt	Chip	Size(mm)	Color	Beam Angle
MR16 MODULE	MR16 -75S-15W	15W	1304/1507/020	82*82*105	WH+BK	15°24°38°55°

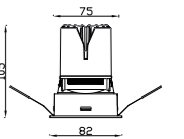

**PARAMETERS**

Name	Model	Watt	Chip	Size(mm)	Color	Beam Angle
MR16 MODULE	MR16 -75ST-10W	10W	1304/1507/020	95*95*94.3	WH+BK	15°24°38°55°

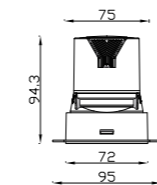

**PARAMETERS**

Name	Model	Watt	Chip	Size(mm)	Color	Beam Angle
MR16 MODULE	MR16 -75ST-15W	15W	1304/1507/020	95*95*105	WH+BK	15°24°38°55°

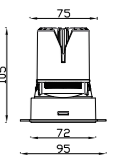

**PARAMETERS**

Name	Model	Watt	Chip	Size(mm)	Color	Beam Angle
MR16 MODULE	MR16 -75SD-10W	10W*2	1304/1507/020	86*158*94.3	WH+BK	15°24°38°55°

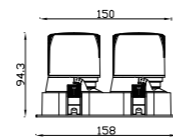

**PARAMETERS**

Name	Model	Watt	Chip	Size(mm)	Color	Beam Angle
MR16 MODULE	MR16 -75SD-15W	15W	1304/1507/020	86*158*105	WH+BK	15°24°38°55°

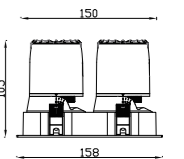

**PARAMETERS**

Name	Model	Watt	Chip	Size(mm)	Color	Beam Angle
MR16 MODULE	MR16 -75SDT-10W	10W*2	1304/1507/020	72*145*94.3	WH+BK	15°24°38°55°

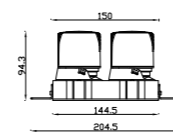

**PARAMETERS**

Name	Model	Watt	Chip	Size(mm)	Color	Beam Angle
MR16 MODULE	MR16 -75SDT-15W	15W	1304/1507/020	72*145*105	WH+BK	15°24°38°55°

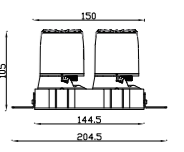

HR SERIES



Product Breakdown Diagram



The change and progress



**PARAMETERS**

Name	Model	Watt	Chip	Size(mm)	Color	Beam Angle
HR SERIES	HR -55R	7W	1304/1507	62*75	WH+BK	15°24°38°55°

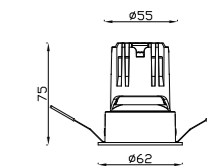

**PARAMETERS**

Name	Model	Watt	Chip	Size(mm)	Color	Beam Angle
HR SERIES	HR -55RT	7W	1304/1507	70*75	WH+BK	15°24°38°55°

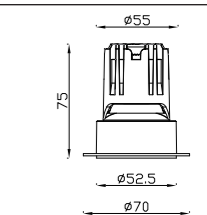

**PARAMETERS**

Name	Model	Watt	Chip	Size(mm)	Color	Beam Angle
HR SERIES	HR -55S	7W	1304/1507	62*62*75	WH+BK	15°24°38°55°

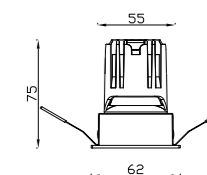

**PARAMETERS**

Name	Model	Watt	Chip	Size(mm)	Color	Beam Angle
HR SERIES	HR -55ST	7W	1304/1507	70*70*75	WH+BK	15°24°38°55°

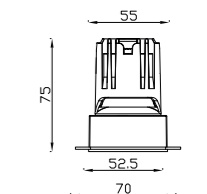

**PARAMETERS**

Name	Model	Watt	Chip	Size(mm)	Color	Beam Angle
HR SERIES	HR -55SD	7W*2	1304/1507	115.5*62*75	WH+BK	15°24°38°55°

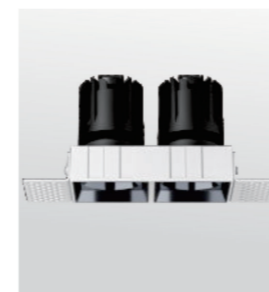
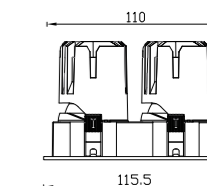

**PARAMETERS**

Name	Model	Watt	Chip	Size(mm)	Color	Beam Angle
HR SERIES	HR -55SDT	7W*2	1304/1507	104.5*52*75	WH+BK	15°24°38°55°

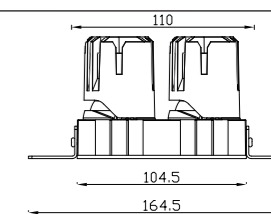



**PARAMETERS**

Name	Model	Watt	Chip	Size(mm)	Color	Beam Angle
HR SERIES	HR -75R	12W	1304/1507/020	83*90	WH+BK	15°24°38°55°

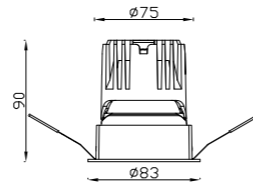

**PARAMETERS**

Name	Model	Watt	Chip	Size(mm)	Color	Beam Angle
HR SERIES	HR -75RT	12W	1304/1507/020	95*90	WH+BK	15°24°38°55°

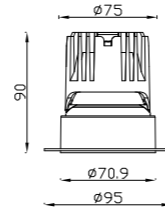

**PARAMETERS**

Name	Model	Watt	Chip	Size(mm)	Color	Beam Angle
HR SERIES	HR -75S	12W	1304/1507/020	82*82*90	WH+BK	15°24°38°55°

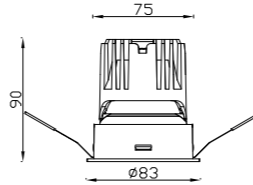

**PARAMETERS**

Name	Model	Watt	Chip	Size(mm)	Color	Beam Angle
HR SERIES	HR -75ST	12W	1304/1507/020	98*98*90	WH+BK	15°24°38°55°

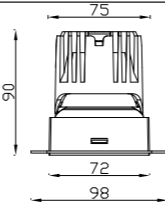

**PARAMETERS**

Name	Model	Watt	Chip	Size(mm)	Color	Beam Angle
HR SERIES	HR -75SD	12W*2	1304/1507/020	158*86*90	WH+BK	15°24°38°55°

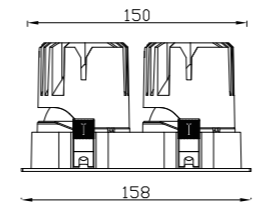

**PARAMETERS**

Name	Model	Watt	Chip	Size(mm)	Color	Beam Angle
HR SERIES	HR -75SDT	12W*2	1304/1507/020	114.5*72*90	WH+BK	15°24°38°55°

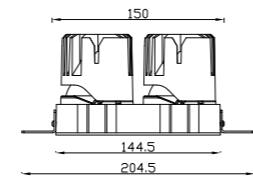

**PARAMETERS**

Name	Model	Watt	Chip	Size(mm)	Color	Beam Angle
HR SERIES	HR -95R	22W	1507/020/1816/030	105*114	WH+BK	15°24°36°55°

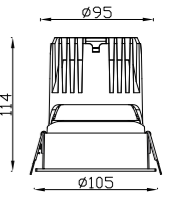

**PARAMETERS**

Name	Model	Watt	Chip	Size(mm)	Color	Beam Angle
HR SERIES	HR -95RT	22W	1507/020/1816/030	120*114	WH+BK	15°24°36°55°

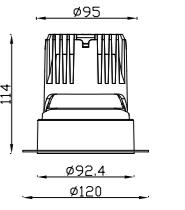

**PARAMETERS**

Name	Model	Watt	Chip	Size(mm)	Color	Beam Angle
HR SERIES	HR -95S	22W	1507/020/1816/030	102.5*102.5*114	WH+BK	15°24°36°55°

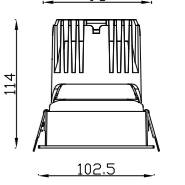

**PARAMETERS**

Name	Model	Watt	Chip	Size(mm)	Color	Beam Angle
HR SERIES	HR -95ST	22W	1507/020/1816/030	120*120*114	WH+BK	15°24°36°55°

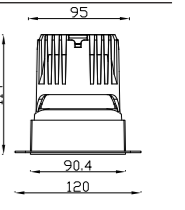

**PARAMETERS**

Name	Model	Watt	Chip	Size(mm)	Color	Beam Angle
HR SERIES	HR -95SD	22W	1507/020/1816/030	197*106.5*114	WH+BK	15°24°36°55°

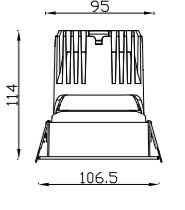

**PARAMETERS**

Name	Model	Watt	Chip	Size(mm)	Color	Beam Angle
HR SERIES	HR -95SDT	22W	1507/020/1816/030	181.5*90.5*114	WH+BK	15°24°36°55°

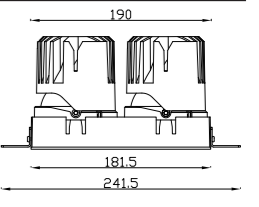





Product Breakdown Diagram

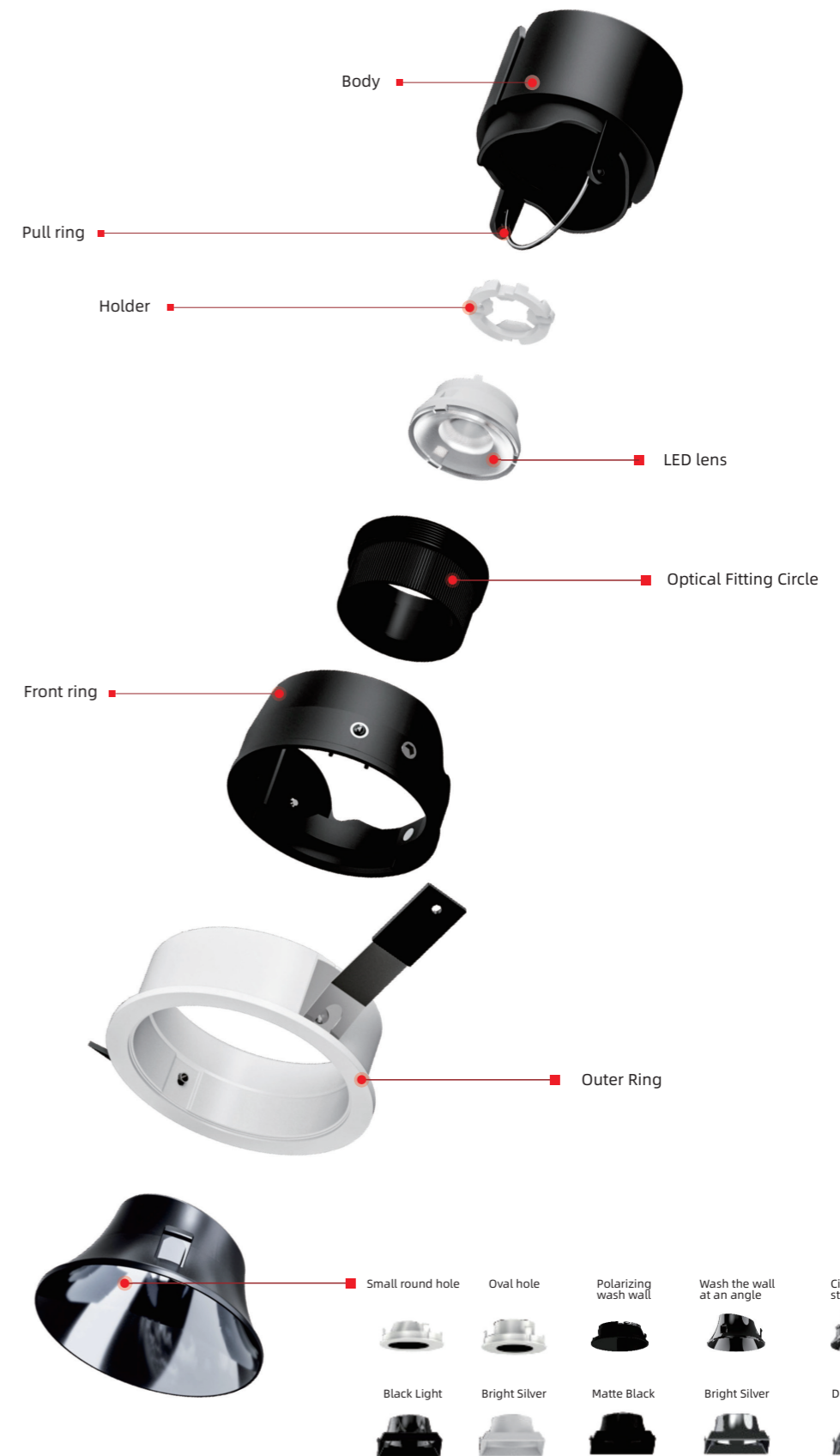



**PARAMETERS**

Name	Model	Watt	Chip	Size(mm)	Color	Beam Angle
TM SERIES	TM -75R	10W	1304/1507/020	82*80	Silver+WH	15°24°38°55°

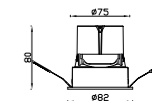

**PARAMETERS**

Name	Model	Watt	Chip	Size(mm)	Color	Beam Angle
TM SERIES	TM -75RT	10W	1304/1507/020	95*80	Silver+WH	15°24°38°55°

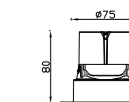

**PARAMETERS**

Name	Model	Watt	Chip	Size(mm)	Color	Beam Angle
TM SERIES	TM -75S	10W	1304/1507/020	82*82*80	Silver+WH	15°24°38°55°

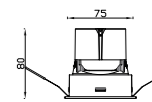

**PARAMETERS**

Name	Model	Watt	Chip	Size(mm)	Color	Beam Angle
TM SERIES	TM -75ST	10W	1304/1507/020	95*95*80	Silver+WH	15°24°38°55°

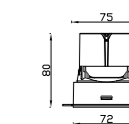

**PARAMETERS**

Name	Model	Watt	Chip	Size(mm)	Color	Beam Angle
TM SERIES	TM -75SD	10W*2	1304/1507/020	86*158*80	Silver+WH	15°24°38°55°

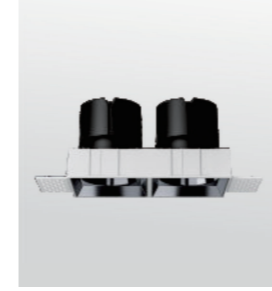
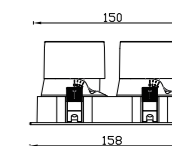

**PARAMETERS**

Name	Model	Watt	Chip	Size(mm)	Color	Beam Angle
TM SERIES	TM -75SDT	10W*2	1304/1507/020	72*145*80	Silver+WH	15°24°38°55°

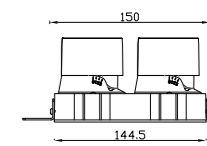

TM Series, Create a premium texture



TG SERIES

Product Breakdown Diagram



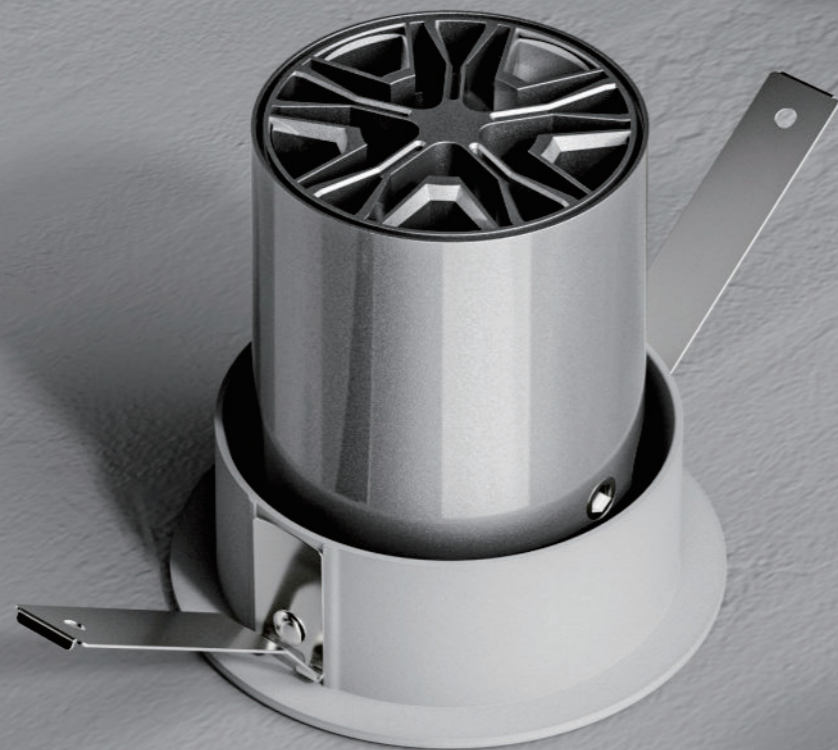

A museum-like  
light for home



**PARAMETERS**

Name	Model	Watt	Chip	Size(mm)	Color	Beam Angle
TG SERIES	TG -55R	7W	1304	62*75	Silver+WH	15°24°38°55°

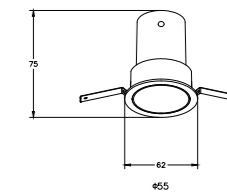

**PARAMETERS**

Name	Model	Watt	Chip	Size(mm)	Color	Beam Angle
TG SERIES	TG -55RT	7W	1304	78*75	Silver+WH	15°24°38°55°

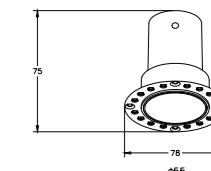

**PARAMETERS**

Name	Model	Watt	Chip	Size(mm)	Color	Beam Angle
TG SERIES	TG -75R	12W	1304/1507/020	85*82	Silver+WH	15°24°38°55°

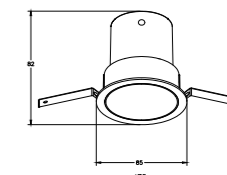

**PARAMETERS**

Name	Model	Watt	Chip	Size(mm)	Color	Beam Angle
TG SERIES	TG -75RT	12W	1304/1507/020	98*82	Silver+WH	15°24°38°55°

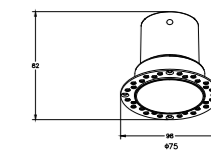

**PARAMETERS**

Name	Model	Watt	Chip	Size(mm)	Color	Beam Angle
TG SERIES	TG -95R	20W	1507/1816/020	105*105	Silver+WH	15°24°38°55°

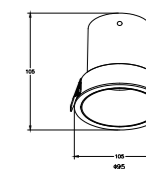

**PARAMETERS**

Name	Model	Watt	Chip	Size(mm)	Color	Beam Angle
TG SERIES	TG -95RT	20W	1507/1816/020	120*105	Silver+WH	15°24°38°55°

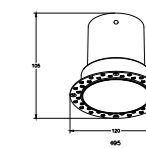

Product Breakdown Diagram

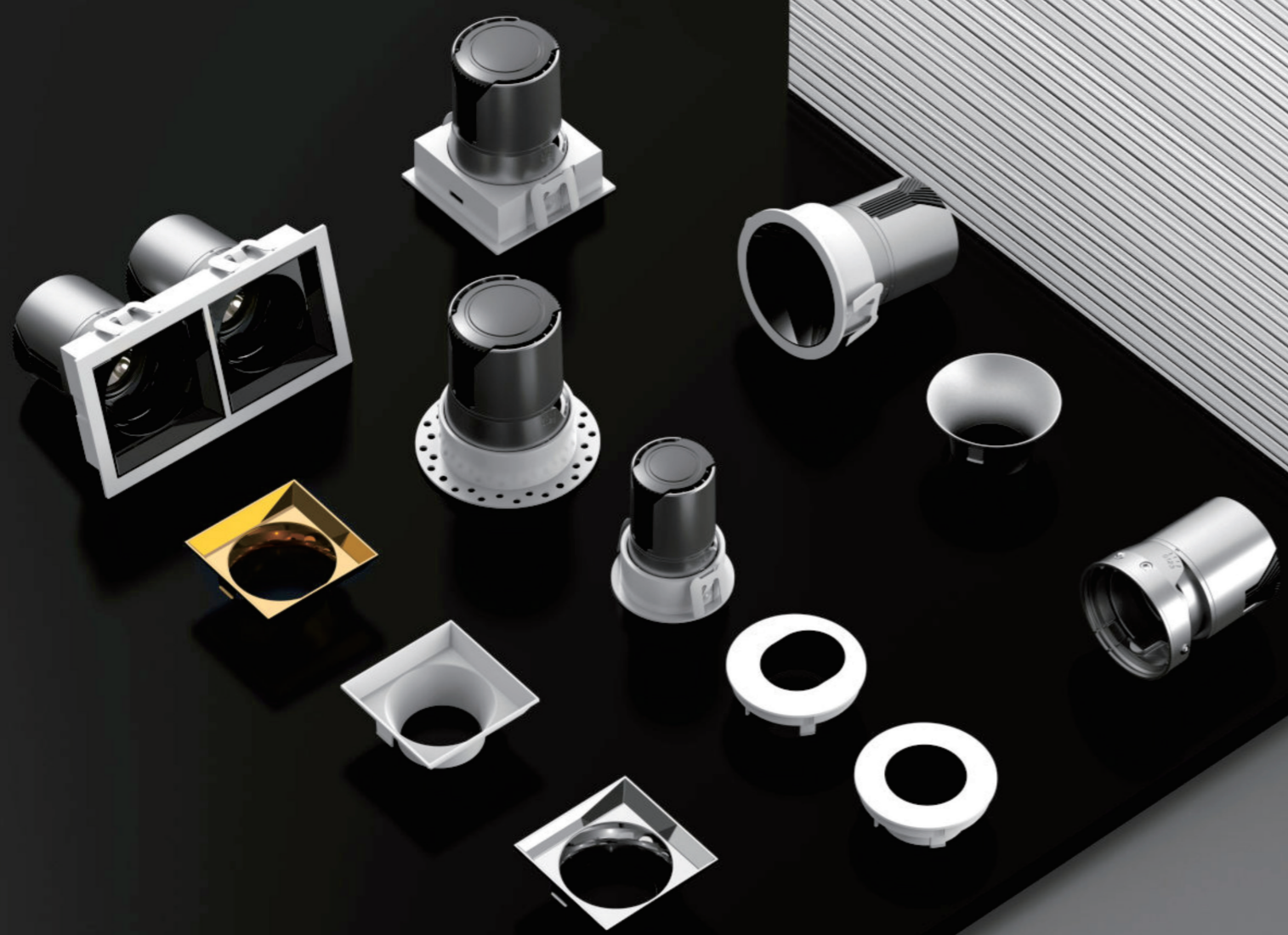
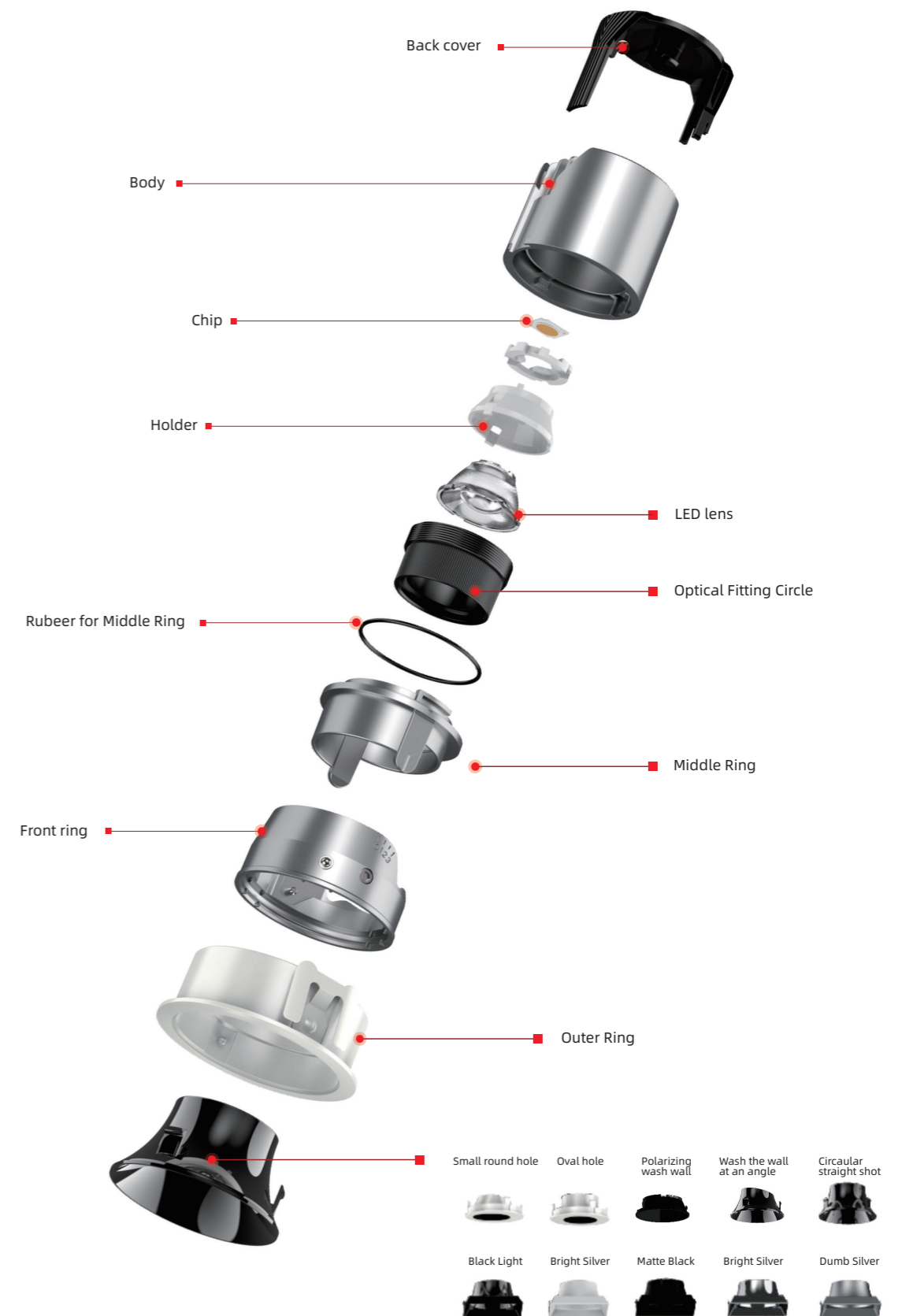



**PARAMETERS**

Name	Model	Watt	Chip	Size(mm)	Color	Beam Angle
QTZ SERIES	QTZ -55R	6W	1304/1507/020	62*80	Silver+WH	15°24°38°55°



**PARAMETERS**

Name	Model	Watt	Chip	Size(mm)	Color	Beam Angle
QTZ SERIES	QTZ -55RT	6W	1304/1507/020	70*80	Silver+WH	15°24°38°55°



**PARAMETERS**

Name	Model	Watt	Chip	Size(mm)	Color	Beam Angle
QTZ SERIES	QTZ -55S	6W	1304/1507/020	62*62*80	Silver+WH	15°24°38°55°



**PARAMETERS**

Name	Model	Watt	Chip	Size(mm)	Color	Beam Angle
QTZ SERIES	QTZ -55ST	6W*2	1304/1507/020	70*70*80	Silver+WH	15°24°38°55°



**PARAMETERS**

Name	Model	Watt	Chip	Size(mm)	Color	Beam Angle
QTZ SERIES	QTZ -55ST	6W*2	1304/1507/020	63*115*80	Silver+WH	15°24°38°55°



**PARAMETERS**

Name	Model	Watt	Chip	Size(mm)	Color	Beam Angle
QTZ SERIES	QTZ -55SDT	6W*2	1304/1507/020	52*105*80	Silver+WH	15°24°38°55°





**PARAMETERS**

Name	Model	Watt	Chip	Size(mm)	Color	Beam Angle
QTZ SERIES	QTZ -75R	10W	1304/1507/020	82*96	Silver+WH	15°24°38°55°



**PARAMETERS**

Name	Model	Watt	Chip	Size(mm)	Color	Beam Angle
QTZ SERIES	QTZ -75R-15W	15W	1304/1507/020	82*103	Silver+WH	15°24°38°55°



**PARAMETERS**

Name	Model	Watt	Chip	Size(mm)	Color	Beam Angle
QTZ SERIES	QTZ -75RT	10W	1304/1507/020	85*96	Silver+WH	15°24°38°55°

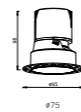

**PARAMETERS**

Name	Model	Watt	Chip	Size(mm)	Color	Beam Angle
QTZ SERIES	QTZ -75RT-15W	15W	1304/1507/020	95*103	Silver+WH	15°24°38°55°



**PARAMETERS**

Name	Model	Watt	Chip	Size(mm)	Color	Beam Angle
QTZ SERIES	QTZ -75S	10W	1304/1507/020	82*82*96	Silver+WH	15°24°38°55°

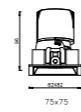

**PARAMETERS**

Name	Model	Watt	Chip	Size(mm)	Color	Beam Angle
QTZ SERIES	QTZ -75S-15W	15W	1304/1507/020	82*82*103	Silver+WH	15°24°38°55°

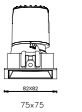

**PARAMETERS**

Name	Model	Watt	Chip	Size(mm)	Color	Beam Angle
QTZ SERIES	QTZ -75ST	10W	1304/1507/020	95*95*96	Silver+WH	15°24°38°55°



**PARAMETERS**

Name	Model	Watt	Chip	Size(mm)	Color	Beam Angle
QTZ SERIES	QTZ -75ST-15W	15W	1304/1507/020	95*95*103	Silver+WH	15°24°38°55°



**PARAMETERS**

Name	Model	Watt	Chip	Size(mm)	Color	Beam Angle
QTZ SERIES	QTZ -75SD	10W*2	1304/1507/020	86*158*96	Silver+WH	15°24°38°55°

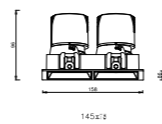

**PARAMETERS**

Name	Model	Watt	Chip	Size(mm)	Color	Beam Angle
QTZ SERIES	QTZ -75SD-15W	15W*2	1304/1507/020	86*158*103	Silver+WH	15°24°38°55°

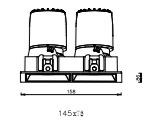

**PARAMETERS**

Name	Model	Watt	Chip	Size(mm)	Color	Beam Angle
QTZ SERIES	QTZ -75SDT	10W*2	1304/1507/020	72*145*96	Silver+WH	15°24°38°55°

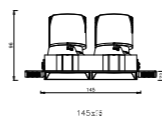

**PARAMETERS**

Name	Model	Watt	Chip	Size(mm)	Color	Beam Angle
QTZ SERIES	QTZ -75SDT-15W	15W*2	1304/1507/020	72*145*103	Silver+WH	15°24°38°55°

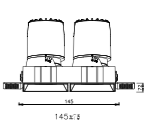

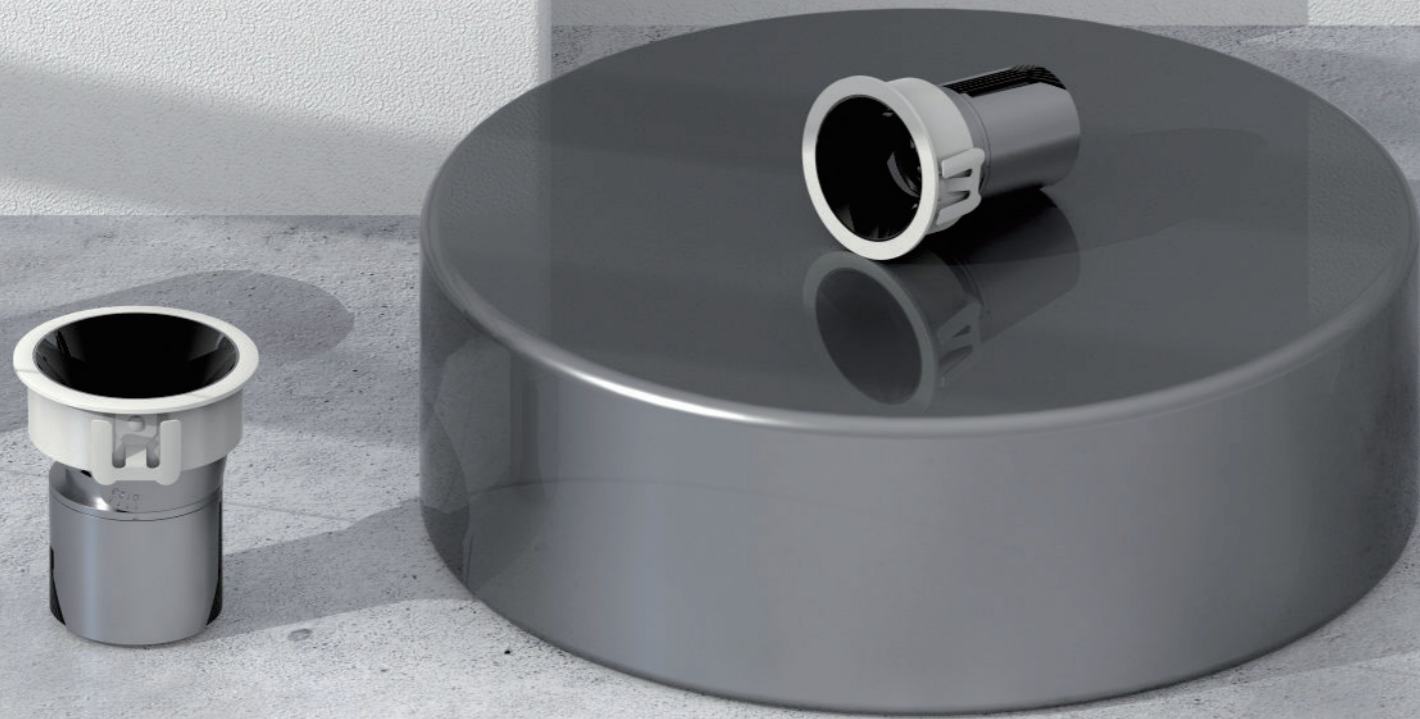

**PARAMETERS**

Name	Model	Watt	Chip	Size(mm)	Color	Beam Angle
QTZ SERIES	QTZ -95R	20W	020/1507/1816	105*119	Silver+WH	15°24°38°55°



**PARAMETERS**

Name	Model	Watt	Chip	Size(mm)	Color	Beam Angle
QTZ SERIES	QTZ -95RT	20W	020/1507/1816	120*119	Silver+WH	15°24°38°55°

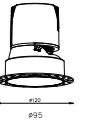

**PARAMETERS**

Name	Model	Watt	Chip	Size(mm)	Color	Beam Angle
QTZ SERIES	QTZ -95S	20W	020/1507/1816	105*105*119	Silver+WH	15°24°38°55°



**PARAMETERS**

Name	Model	Watt	Chip	Size(mm)	Color	Beam Angle
QTZ SERIES	QTZ -95ST	20W	020/1507/1816	120*120*119	Silver+WH	15°24°38°55°



**PARAMETERS**

Name	Model	Watt	Chip	Size(mm)	Color	Beam Angle
QTZ SERIES	QTZ -95SD	20W*2	020/1507/1816	106*197*119	Silver+WH	15°24°38°55°

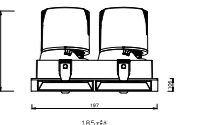

**PARAMETERS**

Name	Model	Watt	Chip	Size(mm)	Color	Beam Angle
QTZ SERIES	QTZ -95SDT	20W*2	020/1507/1816	91*182*119	Silver+WH	15°24°38°55°

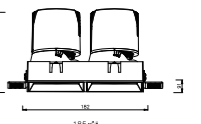





BLM SERIES-COB

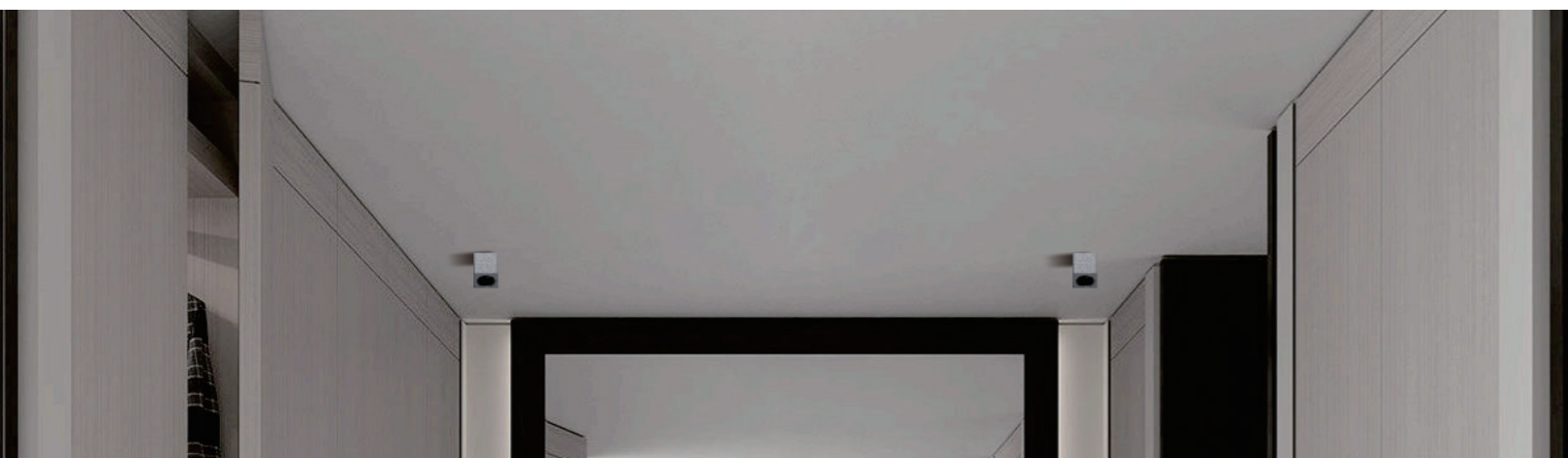

Product Breakdown Diagram

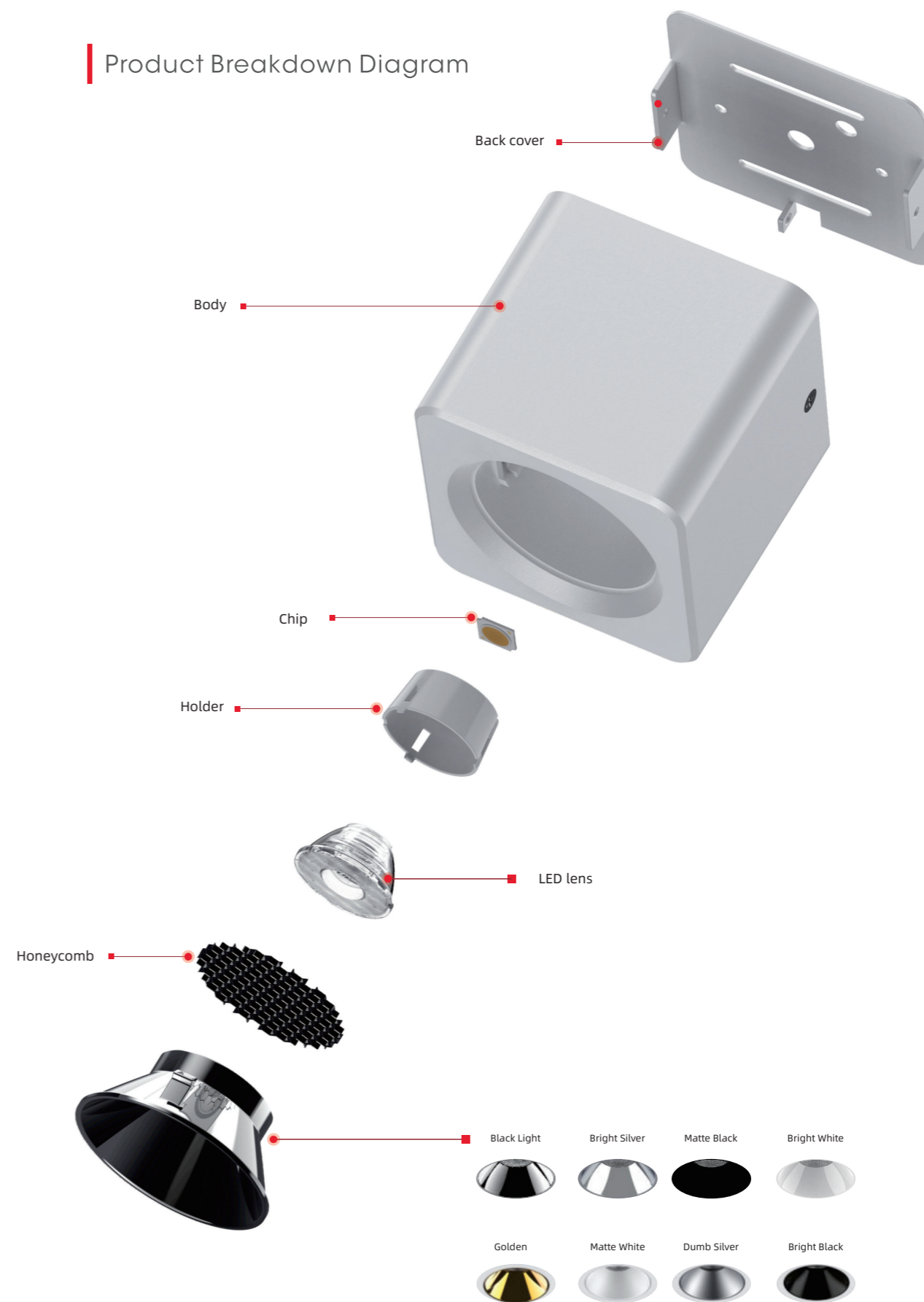

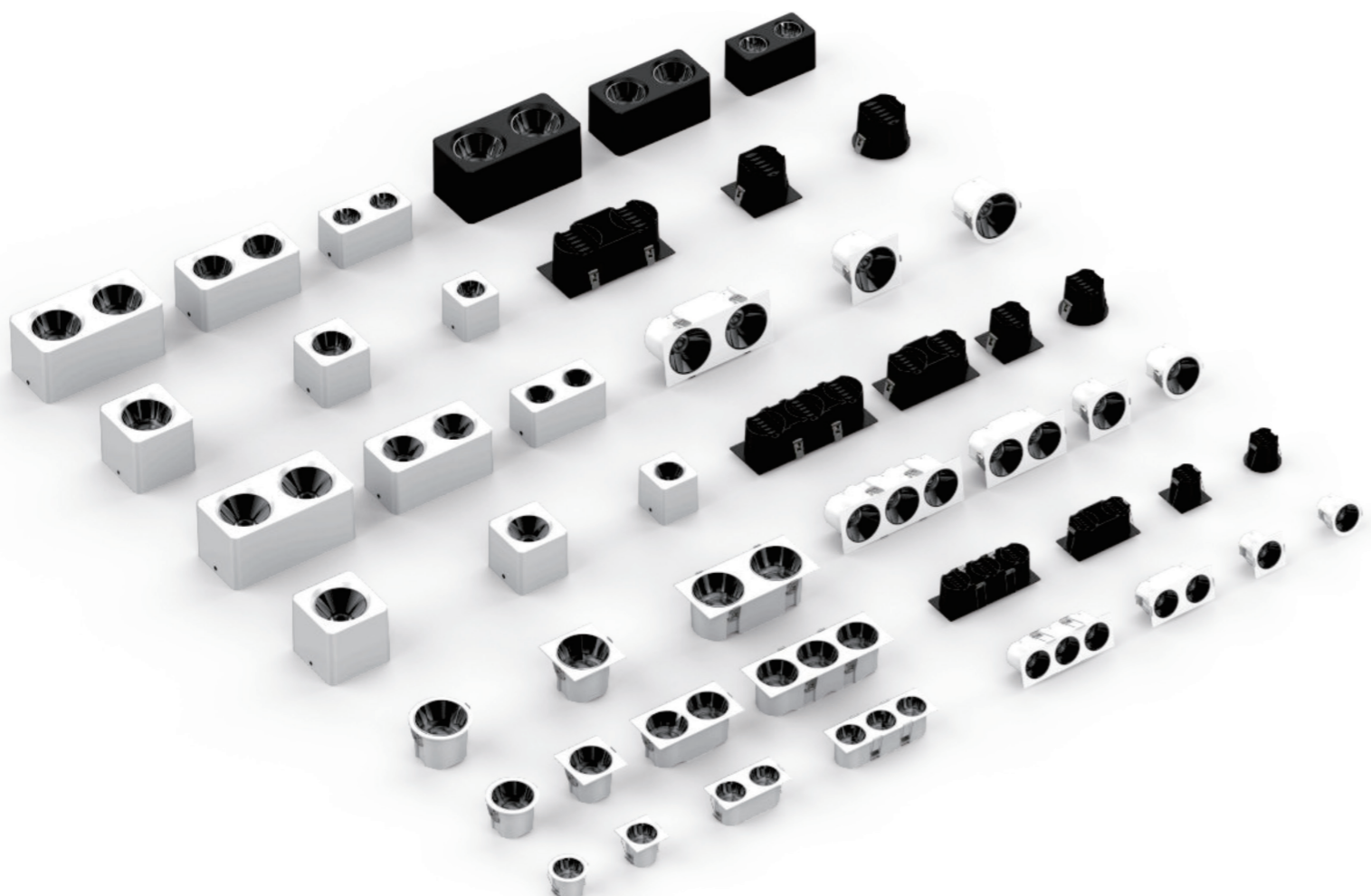

## BLM SERIES-COB



### PARAMETERS

Name	Model	Watt	Chip	Size(mm)	Color	Beam Angle
BLM SERIES-COB	BLM-75-COB	5-8W	1304	75*H75	WH+BK	15°24°38°55°

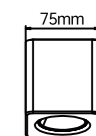

### PARAMETERS

Name	Model	Watt	Chip	Size(mm)	Color	Beam Angle
BLM SERIES-COB	BLM-100-COB	10-15W	1304/1507/020	100*100*H93	WH+BK	15°24°38°55°

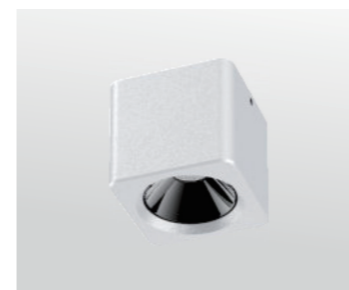
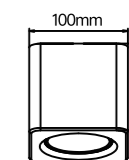

### PARAMETERS

Name	Model	Watt	Chip	Size(mm)	Color	Beam Angle
BLM SERIES-COB	BLM-120-COB	20-24W	1507/020	120*120*H112	WH+BK	15°24°38°55°

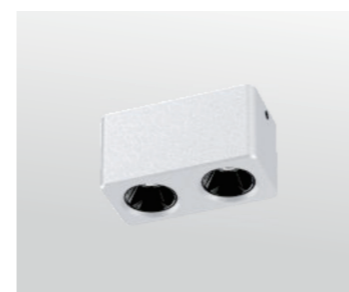
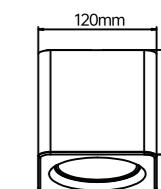

### PARAMETERS

Name	Model	Watt	Chip	Size(mm)	Color	Beam Angle
BLM SERIES-COB	BLM-75D-COB	(5-8)W*2	1304	1150*175*H79	WH+BK	15°24°38°55°

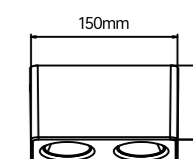

### PARAMETERS

Name	Model	Watt	Chip	Size(mm)	Color	Beam Angle
BLM SERIES-COB	BLM-100D-COB	(10-15)W*2	1304/1507/020	200*100*H93	WH+BK	15°24°38°55°

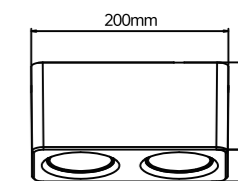

### PARAMETERS

Name	Model	Watt	Chip	Size(mm)	Color	Beam Angle
BLM SERIES-COB	BLM-120D-COB	(20-24)W*2	1507/020	240*120*H112	WH+BK	15°24°38°55°

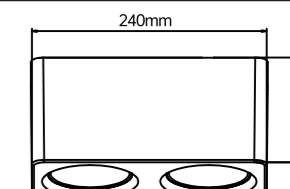



BLM SERIES-SMD

Product Breakdown Diagram

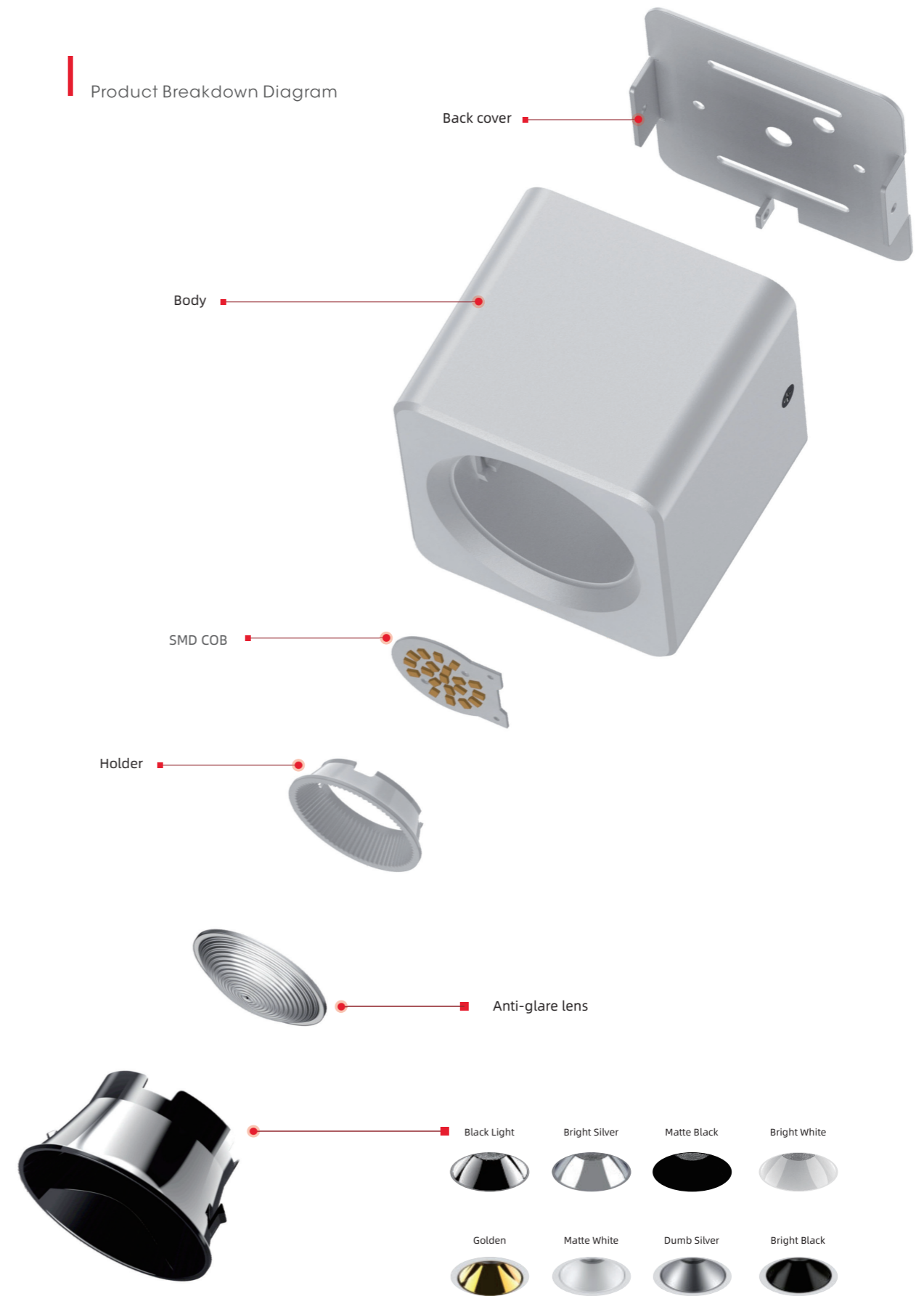

BLM Series-SMD

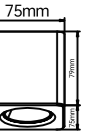

PARAMETERS

Name	Model	Watt	Chip	Size(mm)	Color	Beam Angle
BLM SERIES-SMD	BLM-75-SMD	5-8W	(2835)1W*12	75*H75	WH+BK	60°

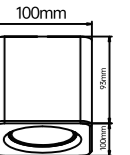

PARAMETERS

Name	Model	Watt	Chip	Size(mm)	Color	Beam Angle
BLM SERIES-SMD	BLM-100-SMD	10-15W	(2835)1W*20	100*100*H93	WH+BK	60°

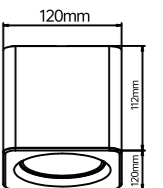
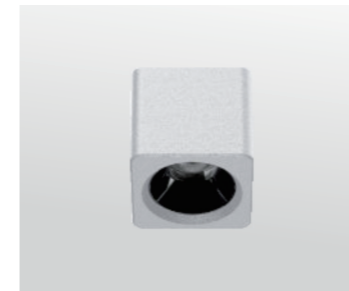

PARAMETERS

Name	Model	Watt	Chip	Size(mm)	Color	Beam Angle
BLM SERIES-SMD	BLM-120-SMD	20-24W	(2835)1W*28	120*120*H112	WH+BK	60°

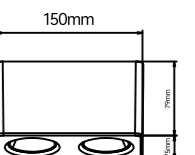

PARAMETERS

Name	Model	Watt	Chip	Size(mm)	Color	Beam Angle
BLM SERIES-SMD	BLM-75D-SMD	(10-15)W*2	(2835)1W*12	150*75*H79	WH+BK	60°

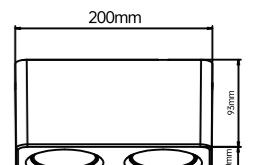

PARAMETERS

Name	Model	Watt	Chip	Size(mm)	Color	Beam Angle
BLM SERIES-SMD	BLM-100D-SMD	(10-15)W*2	(2835)1W*20	200*100*H93	WH+BK	60°

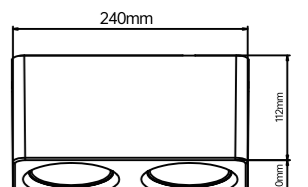

PARAMETERS

Name	Model	Watt	Chip	Size(mm)	Color	Beam Angle
BLM SERIES-SMD	BLM-120D-SMD	(20-24)W*2	(2835)1W*28	240*120*H112	WH+BK	60°

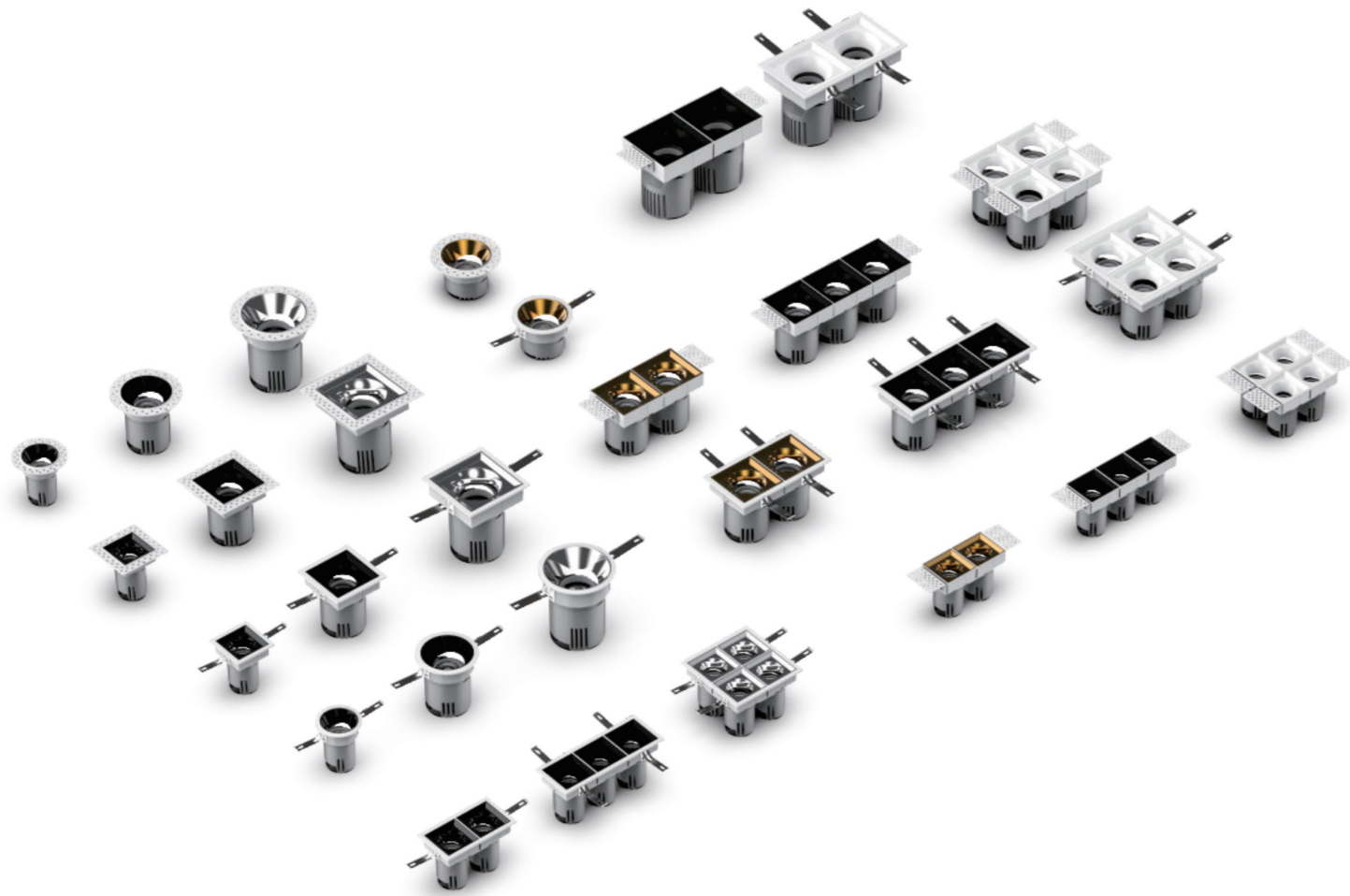

DHF SERIES

Product Breakdown Diagram

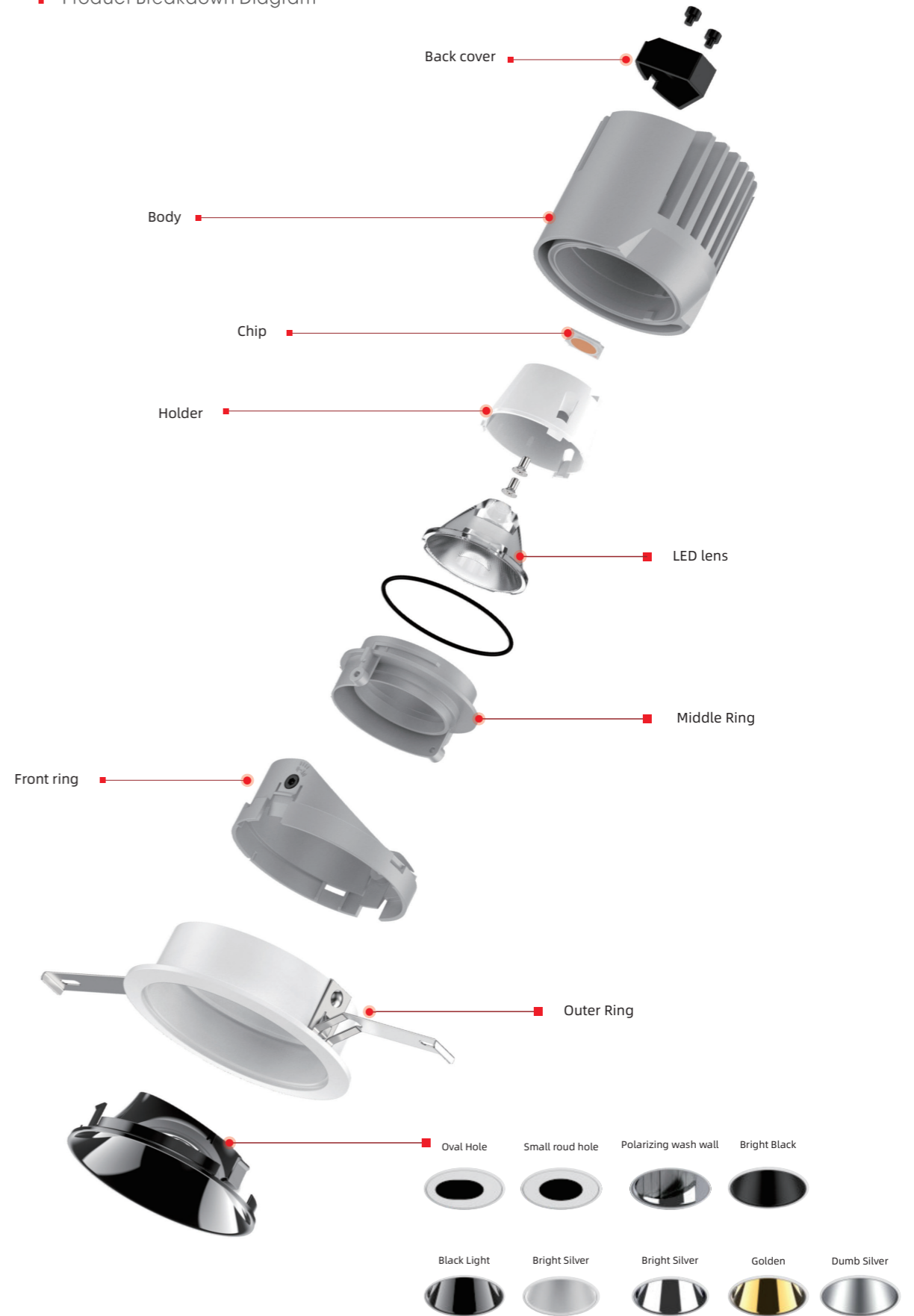

Breakthrough is never the same

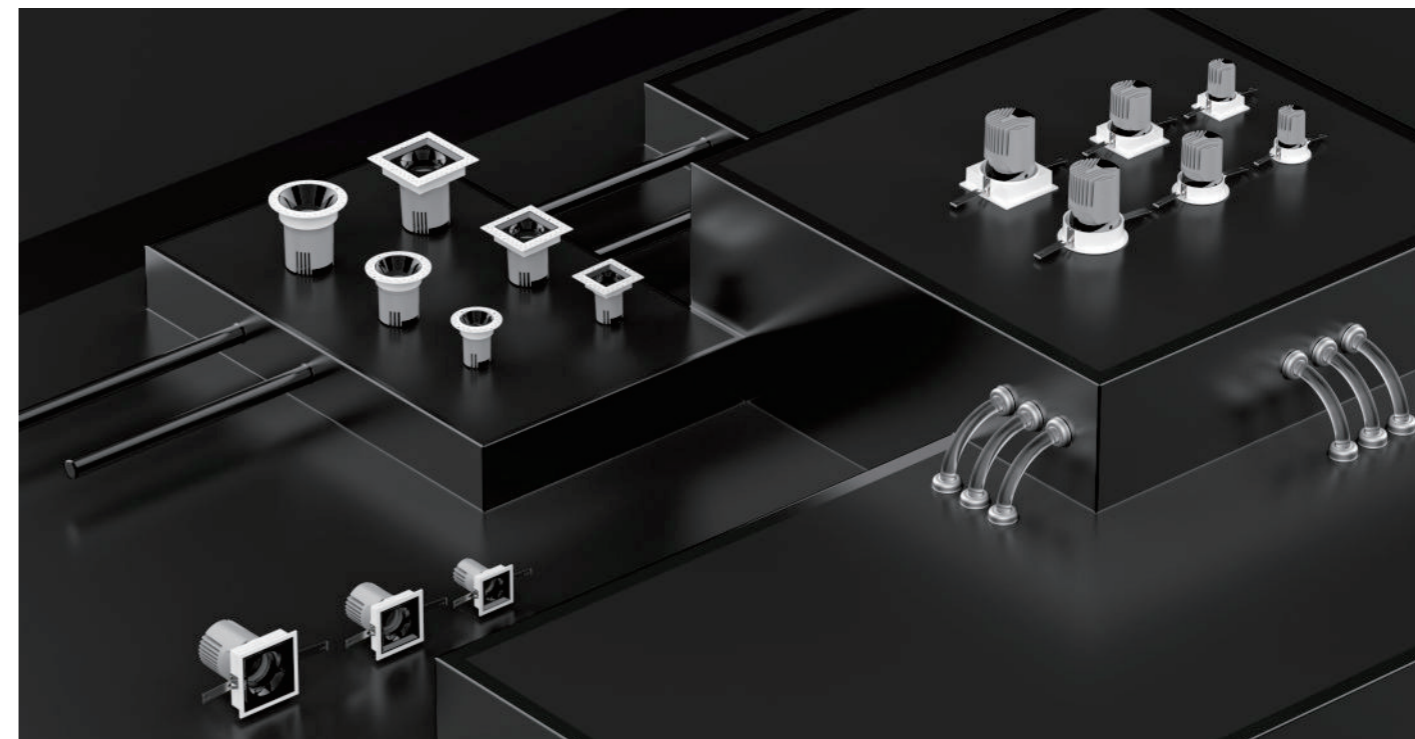
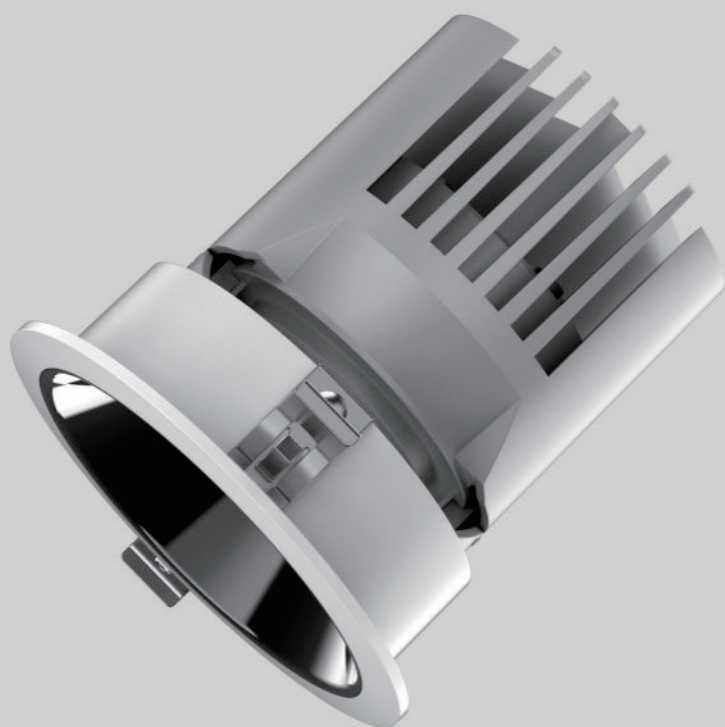

**PARAMETERS**

Name	Model	Watt	Chip	Size(mm)	Color	Beam Angle
DHF SERIES	DHF-55R	5-7W	1304	62*75	Gray+WH	15°24°38°55°

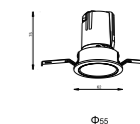

**PARAMETERS**

Name	Model	Watt	Chip	Size(mm)	Color	Beam Angle
DHF SERIES	DHF-55S	5-7W	1304	62*75*62	Gray+WH	15°24°38°55°

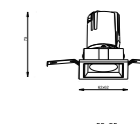

**PARAMETERS**

Name	Model	Watt	Chip	Size(mm)	Color	Beam Angle
DHF SERIES	DHF-55RT	5-7W	1304/1507/020	77*75	Gray+WH	15°24°38°55°

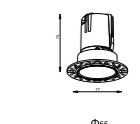

**PARAMETERS**

Name	Model	Watt	Chip	Size(mm)	Color	Beam Angle
DHF SERIES	DHF-55ST	5-7W	1304	77*75*77	Gray+WH	15°24°38°55°

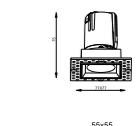



**PARAMETERS**

Name	Model	Watt	Chip	Size(mm)	Color	Beam Angle
DHF SERIES	DHF-55DS	5-7W*2	1304	114*76*62	Gray+WH	15°24°38°55°

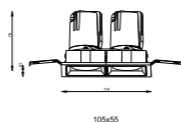

**PARAMETERS**

Name	Model	Watt	Chip	Size(mm)	Color	Beam Angle
DHF SERIES	DHF-55TS	5-7W*3	1304	166*76*62	Gray+WH	15°24°38°55°

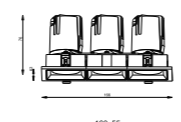

**PARAMETERS**

Name	Model	Watt	Chip	Size(mm)	Color	Beam Angle
DHF SERIES	DHF-55FS	5-7W*4	1304	114*76*114	Gray+WH	15°24°38°55°

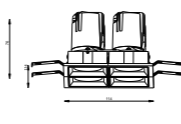

**PARAMETERS**

Name	Model	Watt	Chip	Size(mm)	Color	Beam Angle
DHF SERIES	DHF-55DST	5-7W*2	1304	104*76*52	Gray+WH	15°24°38°55°

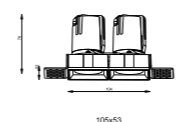

**PARAMETERS**

Name	Model	Watt	Chip	Size(mm)	Color	Beam Angle
DHF SERIES	DHF-55TST	5-7W*3	1304	157*76*52	Gray+WH	15°24°38°55°

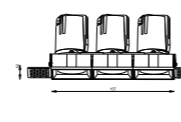

**PARAMETERS**

Name	Model	Watt	Chip	Size(mm)	Color	Beam Angle
DHF SERIES	DHF-55FST	5-7W*4	1304	104*76*104	Gray+WH	15°24°38°55°

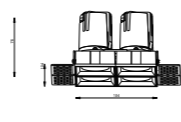

**PARAMETERS**

Name	Model	Watt	Chip	Size(mm)	Color	Beam Angle
DHF SERIES	DHF-75R-Thin	5-7W	1304/1507/020	85*60	Gray+WH	15°24°38°55°

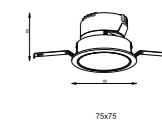

**PARAMETERS**

Name	Model	Watt	Chip	Size(mm)	Color	Beam Angle
DHF SERIES	DHF-75S-Thin	5-7W	1304/1507/020	85*60*85	Gray+WH	15°24°38°55°

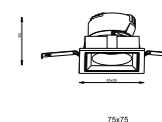

**PARAMETERS**

Name	Model	Watt	Chip	Size(mm)	Color	Beam Angle
DHF SERIES	DHF-75RT-Thin	5-7W	1304/1507/020	100*60	Gray+WH	15°24°38°55°

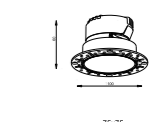

**PARAMETERS**

Name	Model	Watt	Chip	Size(mm)	Color	Beam Angle
DHF SERIES	DHF-75ST-Thin	5-7W	1304/1507/020	100*60*100	Gray+WH	15°24°38°55°

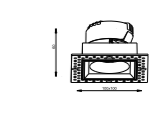



**PARAMETERS**

Name	Model	Watt	Chip	Size(mm)	Color	Beam Angle
DHF SERIES	DHF-75DS-Thin	5-7W*2	1304/1507/020	158*60*85	Gray+WH	15°24°38°55°

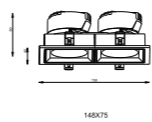

**PARAMETERS**

Name	Model	Watt	Chip	Size(mm)	Color	Beam Angle
DHF SERIES	DHF-75TS-Thin	5-7W*3	1304/1507/020	230*60*85	Gray+WH	15°24°38°55°

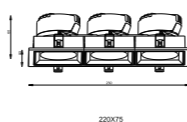

**PARAMETERS**

Name	Model	Watt	Chip	Size(mm)	Color	Beam Angle
DHF SERIES	DHF-75FS-Thin	5-7W*4	1304/1507/020	158*60*158	Gray+WH	15°24°38°55°

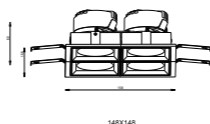

**PARAMETERS**

Name	Model	Watt	Chip	Size(mm)	Color	Beam Angle
DHF SERIES	DHF-75DST-Thin	5-7W*2	1304/1507/020	144*60*72	Gray+WH	15°24°38°55°

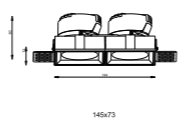

**PARAMETERS**

Name	Model	Watt	Chip	Size(mm)	Color	Beam Angle
DHF SERIES	DHF-75TST-Thin	5-7W*3	1304/1507/020	216*60*72	Gray+WH	15°24°38°55°

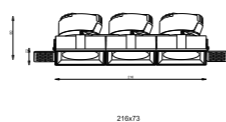

**PARAMETERS**

Name	Model	Watt	Chip	Size(mm)	Color	Beam Angle
DHF SERIES	DHF-75FST-Thin	5-7W*4	1304/1507/020	144*60*144	Gray+WH	15°24°38°55°

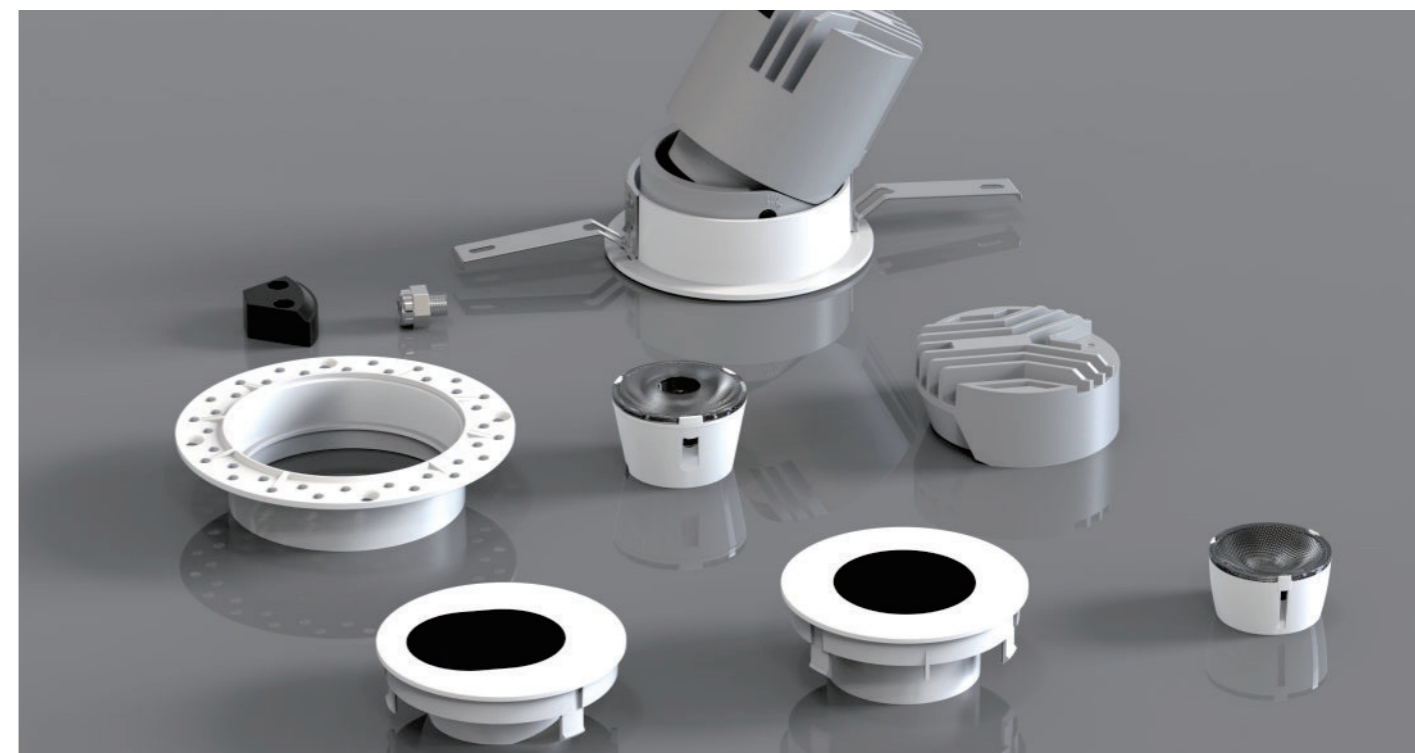
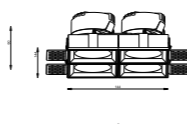

**PARAMETERS**

Name	Model	Watt	Chip	Size(mm)	Color	Beam Angle
DHF SERIES	DHF-75R	12-15W	1304/1507/020	85*90	Gray+WH	15°24°38°55°



**PARAMETERS**

Name	Model	Watt	Chip	Size(mm)	Color	Beam Angle
DHF SERIES	DHF-75S	12-15W	1304/1507/020	85*90*85	Gray+WH	15°24°38°55°

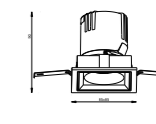

**PARAMETERS**

Name	Model	Watt	Chip	Size(mm)	Color	Beam Angle
DHF SERIES	DHF-75RT	12-15W	1304/1507/020	120*120*H112	Gray+WH	15°24°38°55°

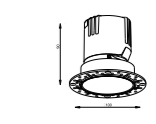

**PARAMETERS**

Name	Model	Watt	Chip	Size(mm)	Color	Beam Angle
DHF SERIES	DHF-75ST	12-15W	1304/1507/020	100*90*100	Gray+WH	15°24°38°55°

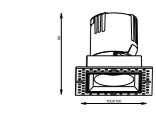





**PARAMETERS**

Name	Model	Watt	Chip	Size(mm)	Color	Beam Angle
DHF SERIES	DHF-75DS	12-15W*2	1304/1507/020	158*90*85	Gray+WH	15°24°38°55°

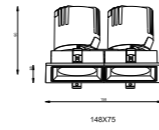

**PARAMETERS**

Name	Model	Watt	Chip	Size(mm)	Color	Beam Angle
DHF SERIES	DHF-95R	20-25W	1507/1816/020	104*115	Gray+WH	15°24°38°55°

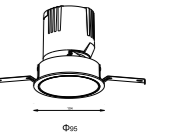

**PARAMETERS**

Name	Model	Watt	Chip	Size(mm)	Color	Beam Angle
DHF SERIES	DHF-75TS	12-15W*3	1304/1507/020	230*90*85	Gray+WH	15°24°38°55°

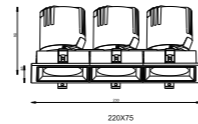

**PARAMETERS**

Name	Model	Watt	Chip	Size(mm)	Color	Beam Angle
DHF SERIES	DHF-95S	20-25W	1507/1816/020	104*115*104	Gray+WH	15°24°38°55°

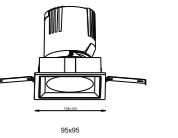

**PARAMETERS**

Name	Model	Watt	Chip	Size(mm)	Color	Beam Angle
DHF SERIES	DHF-75FS	12-15W*4	1304/1507/020	158*90*158	Gray+WH	15°24°38°55°

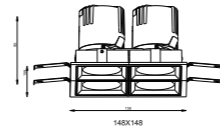

**PARAMETERS**

Name	Model	Watt	Chip	Size(mm)	Color	Beam Angle
DHF SERIES	DHF-95RT	20-25W	1507/1816/020	120*115	Gray+WH	15°24°38°55°

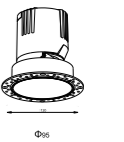

**PARAMETERS**

Name	Model	Watt	Chip	Size(mm)	Color	Beam Angle
DHF SERIES	DHF-75DST	12-15W*2	1304/1507/020	144*90*72	Gray+WH	15°24°38°55°

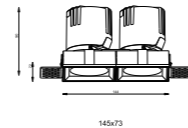

**PARAMETERS**

Name	Model	Watt	Chip	Size(mm)	Color	Beam Angle
DHF SERIES	DHF-95ST	20-25W	1507/1816/020	120*115*120	Gray+WH	15°24°38°55°

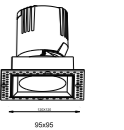

**PARAMETERS**

Name	Model	Watt	Chip	Size(mm)	Color	Beam Angle
DHF SERIES	DHF-75TST	12-15W*3	1304/1507/020	216*90*72	Gray+WH	15°24°38°55°

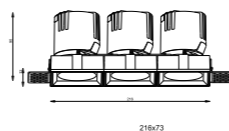

**PARAMETERS**

Name	Model	Watt	Chip	Size(mm)	Color	Beam Angle
DHF SERIES	DHF-95SD	20-25W*2	1507/1816/020	196*116*104	Gray+WH	15°24°38°55°

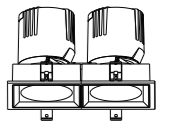

**PARAMETERS**

Name	Model	Watt	Chip	Size(mm)	Color	Beam Angle
DHF SERIES	DHF-75FST	12-15W*4	1304/1507/020	144*90*144	Gray+WH	15°24°38°55°

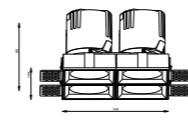

**PARAMETERS**

Name	Model	Watt	Chip	Size(mm)	Color	Beam Angle
DHF SERIES	DHF-95SDT	20-25W*2	1507/1816/020	184*116*92	Gray+WH	15°24°38°55°

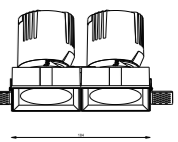

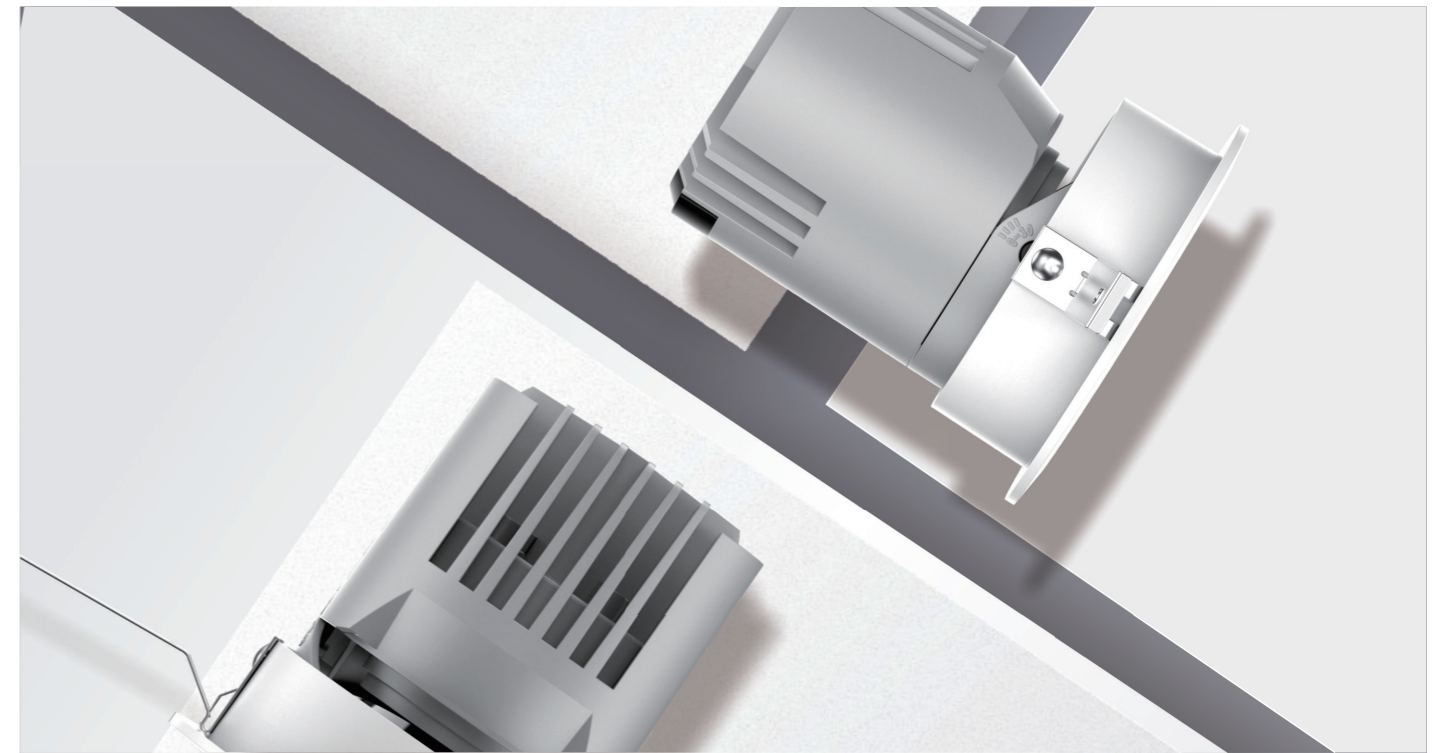

**PARAMETERS**

Name	Model	Watt	Chip	Size(mm)	Color	Beam Angle
DHF SERIES	DHF-120R	30-55W	1816/2520/030	140*149	Gray+WH	15°24°38°55°

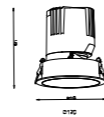

**PARAMETERS**

Name	Model	Watt	Chip	Size(mm)	Color	Beam Angle
DHF SERIES	DHF-145R	50-55W	1816/2520/030	168*179	Gray+WH	15°24°38°55°

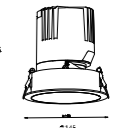

**PARAMETERS**

Name	Model	Watt	Chip	Size(mm)	Color	Beam Angle
DHF SERIES	DHF-120S	30-55W	1816/2520/030	140*140*149	Gray+WH	15°24°38°55°

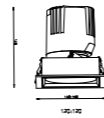

**PARAMETERS**

Name	Model	Watt	Chip	Size(mm)	Color	Beam Angle
DHF SERIES	DHF-145S	50-55W	1816/2520/030	168*168*179	Gray+WH	15°24°38°55°

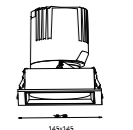

**PARAMETERS**

Name	Model	Watt	Chip	Size(mm)	Color	Beam Angle
DHF SERIES	DHF-120RT	30-55W	1816/2520/030	120*149	Gray+WH	15°24°38°55°

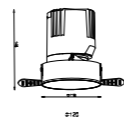

**PARAMETERS**

Name	Model	Watt	Chip	Size(mm)	Color	Beam Angle
DHF SERIES	DHF-145RT	50-55W	1816/2520/030	140*179	Gray+WH	15°24°38°55°

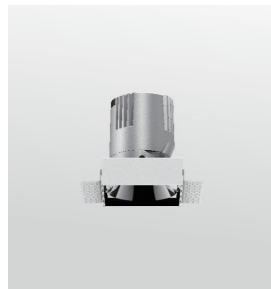
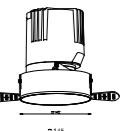

**PARAMETERS**

Name	Model	Watt	Chip	Size(mm)	Color	Beam Angle
DHF SERIES	DHF-120ST	30-55W	1816/2520/030	120*120*149	Gray+WH	15°24°38°55°

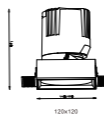

**PARAMETERS**

Name	Model	Watt	Chip	Size(mm)	Color	Beam Angle
DHF SERIES	DHF-145ST	50-55W	1816/2520/030	140*140*179	Gray+WH	15°24°38°55°

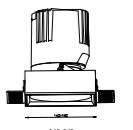

# LD SERIES

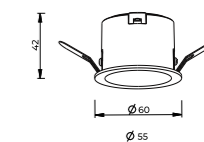
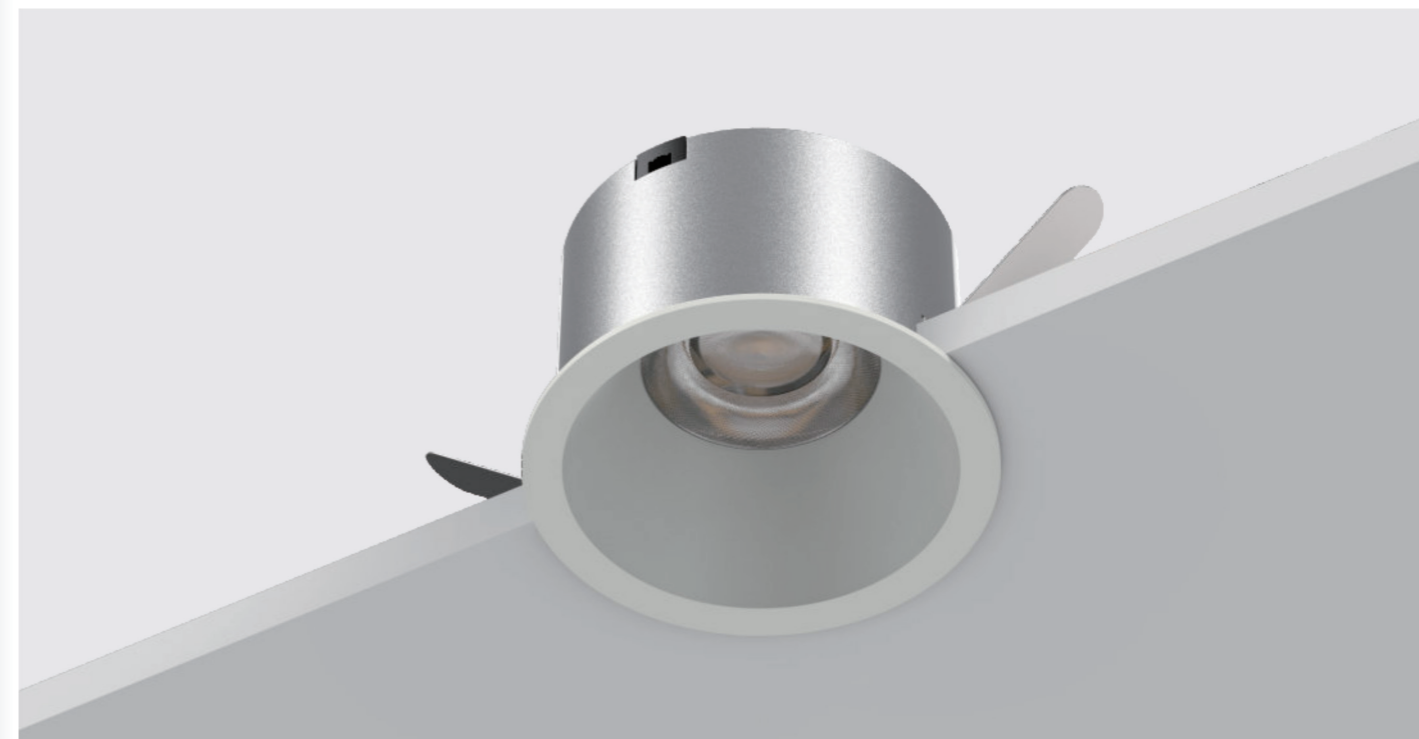

### PARAMETERS

Name	Model	Watt	Chip	Size(mm)	Cutout	Color	Beam Angle
LD SREIES	LD-55	5W	1304	60*42	55	Gray	15°/24°/38°/60°

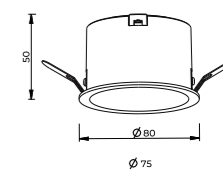

### PARAMETERS

Name	Model	Watt	Chip	Size(mm)	Cutout	Color	Beam Angle
LD SREIES	LD-75	10W	1304/1507/020	80*50	75	Gray	15°/24°/38°/60°

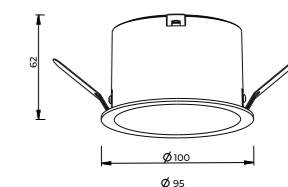

### PARAMETERS

Name	Model	Watt	Chip	Size(mm)	Cutout	Color	Beam Angle
LD SREIES	LD-95	20W	1507/1816/020/030	100*62	95	Gray	15°/24°/38°/60°



## BL SERIES-COB

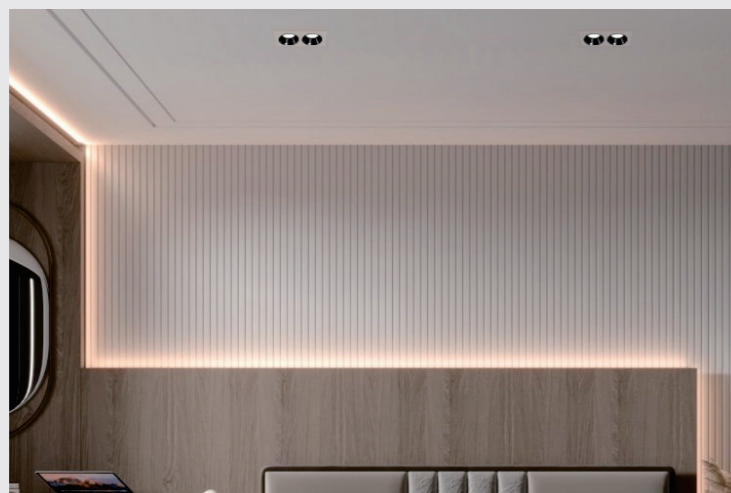

### Product Breakdown Diagram



# DOWNLIGHT

BL Series-COB —



### PARAMETERS

Name	Model	Watt	Chip	Size(mm)	Cutout	Color	Beam Angle
BL SERIES-COB	BL-55R-COB	5-7W	1304	63*52	55*55	WH+BK	15°/24°/38°/55°

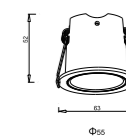

### PARAMETERS

Name	Model	Watt	Chip	Size(mm)	Cutout	Color	Beam Angle
BL SERIES-COB	BL-55S-COB	5-7W	1304	63*63*52	55*55	WH+BK	15°/24°/38°/55°

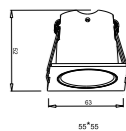

### PARAMETERS

Name	Model	Watt	Chip	Size(mm)	Cutout	Color	Beam Angle
BL SERIES-COB	BL-55SSD-COB	(5-7)W*2	1304	130*63*52	120*55	WH+BK	15°/24°/38°/55°

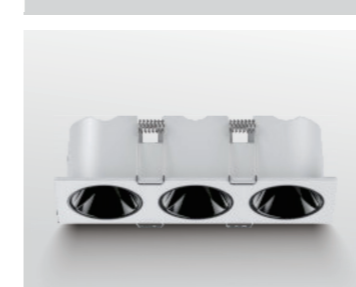
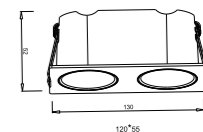

### PARAMETERS

Name	Model	Watt	Chip	Size(mm)	Cutout	Color	Beam Angle
BL SERIES-COB	BL-55SST-COB	(5-7)W*3	1304	185*63*52	175*55	WH+BK	15°/24°/38°/55°

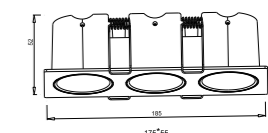



**PARAMETERS**

Name	Model	Watt	Chip	Size(mm)	Cutout	Color	Beam Angle
BL SERIES-COB	BL-75R-COB	8-10W	1304/1507/020	85*64	75	WH+BK	15°/24°/38°/55°

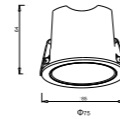

**PARAMETERS**

Name	Model	Watt	Chip	Size(mm)	Cutout	Color	Beam Angle
BL SERIES-COB	BL-75S-COB	8-10W	1304/1507/020	85*85*64	75*75	WH+BK	15°/24°/38°/55°

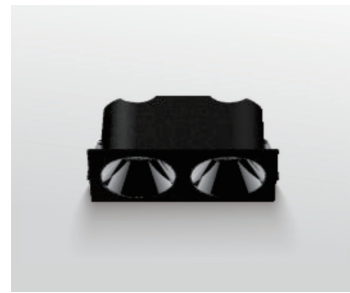
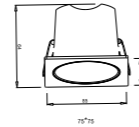

**PARAMETERS**

Name	Model	Watt	Chip	Size(mm)	Cutout	Color	Beam Angle
BL SERIES-COB	BL-75SD-COB	(8-10)*2W	1304/1507/020	165*85*64	150*75	WH+BK	15°/24°/38°/55°

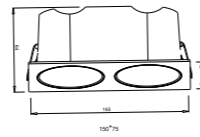

**PARAMETERS**

Name	Model	Watt	Chip	Size(mm)	Cutout	Color	Beam Angle
BL SERIES-COB	BL-75ST-COB	(8-10)*3W	1304/1507/020	240*85*64	230*75	WH+BK	15°/24°/38°/55°

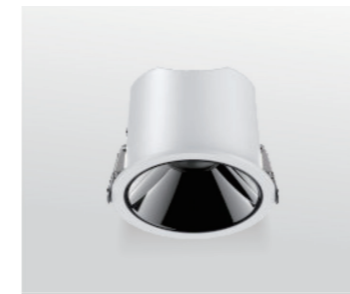
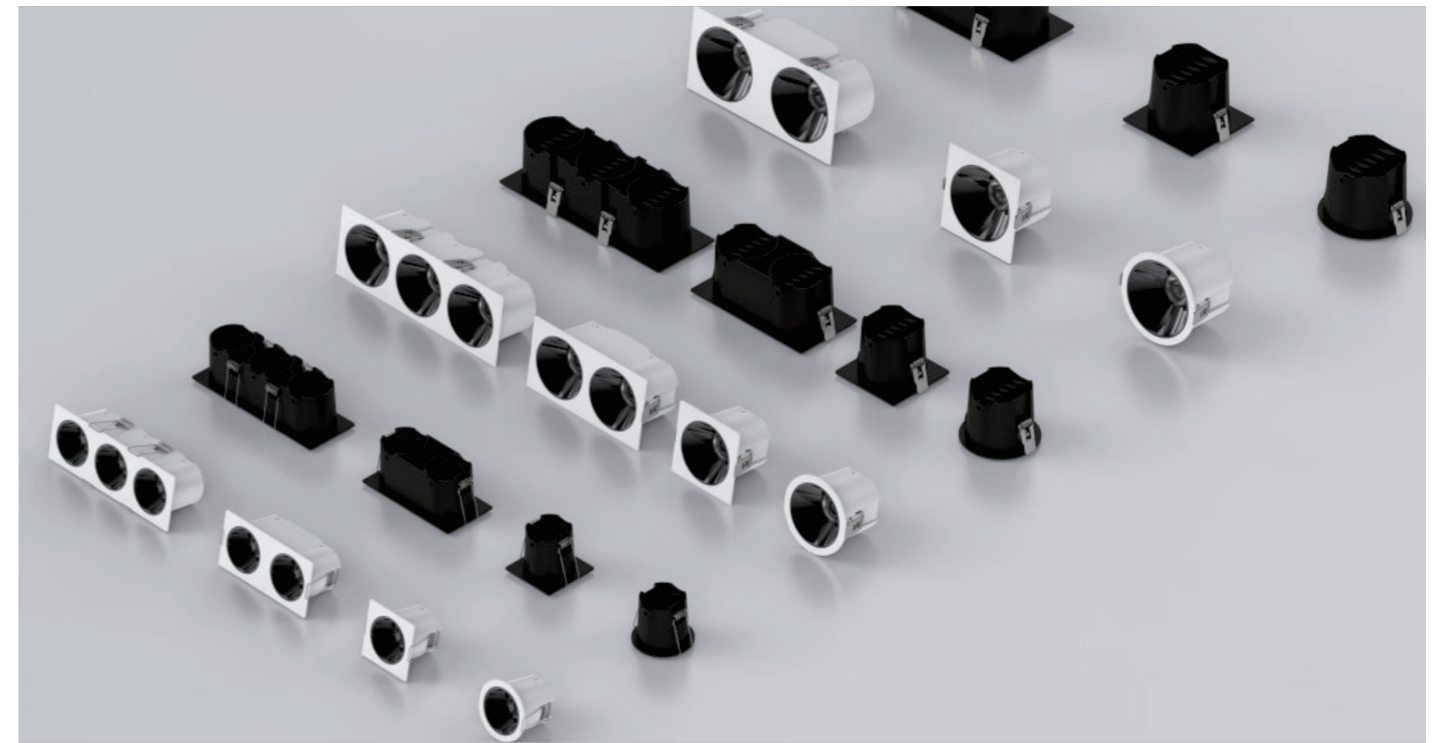
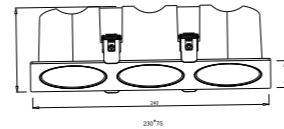

**PARAMETERS**

Name	Model	Watt	Chip	Size(mm)	Cutout	Color	Beam Angle
BL SERIES-COB	BL-90R-COB	15-18W	1507/020	102*74	90	WH+BK	15°/24°/38°/55°

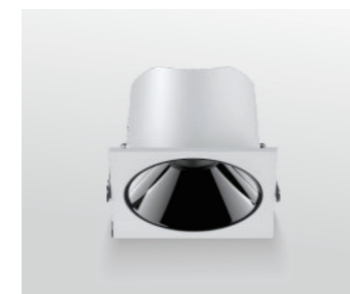
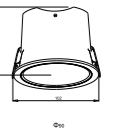

**PARAMETERS**

Name	Model	Watt	Chip	Size(mm)	Cutout	Color	Beam Angle
BL SERIES-COB	BL-90S-COB	15-18W	1507/020	102*102*74	90*90	WH+BK	15°/24°/38°/55°

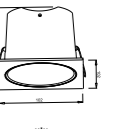

**PARAMETERS**

Name	Model	Watt	Chip	Size(mm)	Cutout	Color	Beam Angle
BL SERIES-COB	BL-90SD-COB	(15-18)W*2	1507/020	220*102*74	205*90	WH+BK	15°/24°/38°/55°

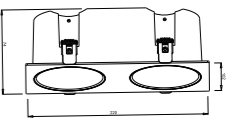

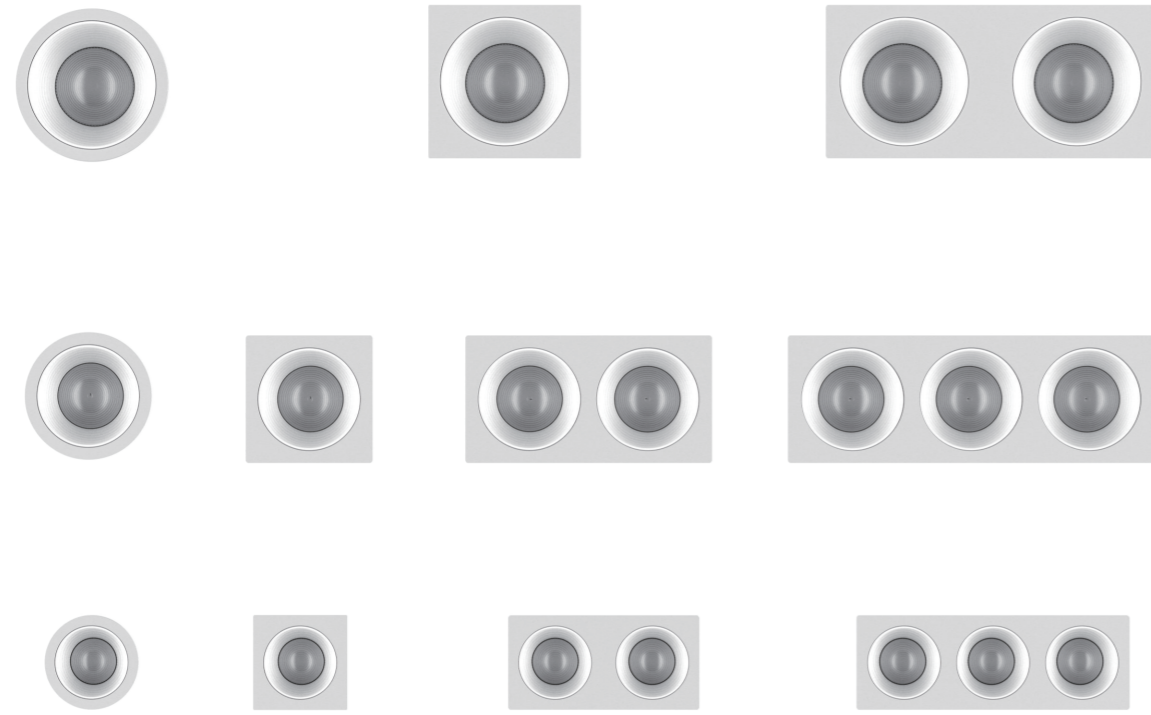

## BL SERIES-SMD



### Product Breakdown Diagram





DOWNLIGHT



**PARAMETERS**

Name	Model	Watt	Chip	Size(mm)	Cutout	Color	Beam Angle
BL SERIES-SMD	BL-55R-SMD	5-8W	(2835)1W*12	63*52	55	WH+BK	60°

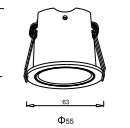

**PARAMETERS**

Name	Model	Watt	Chip	Size(mm)	Cutout	Color	Beam Angle
BL SERIES-SMD	BL-55S-SMD	5-8W	(2835)1W*12	63*60/32	55*55	WH+BK	60°

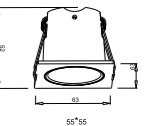

**PARAMETERS**

Name	Model	Watt	Chip	Size(mm)	Cutout	Color	Beam Angle
BL SERIES-SMD	BL-55SD-SMD	(5-8)W*2	(2835)1W*12	130*63*52	120*55	WH+BK	60°

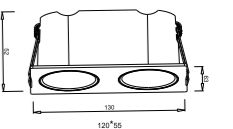

**PARAMETERS**

Name	Model	Watt	Chip	Size(mm)	Cutout	Color	Beam Angle
BL SERIES-SMD	BL-55ST-SMD	(5-8)W*3	(2835)1W*12	185*63*52	175*55	WH+BK	60°

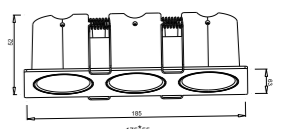





**PARAMETERS**

Name	Model	Watt	Chip	Size(mm)	Cutout	Color	Beam Angle
BL SERIES-SMD	BL-75R-SMD	10-15W	(2835)1W*20	85*64	75	WH+BK	60°

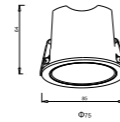

**PARAMETERS**

Name	Model	Watt	Chip	Size(mm)	Cutout	Color	Beam Angle
BL SERIES-SMD	BL-75S-SMD	10-15W	(2835)1W*20	85*85*64	75*75	WH+BK	60°

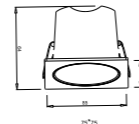

**PARAMETERS**

Name	Model	Watt	Chip	Size(mm)	Cutout	Color	Beam Angle
BL SERIES-SMD	BL-75SD-SMD	(10-15)W*2	(2835)1W*20	165*85*64	150*75	WH+BK	60°

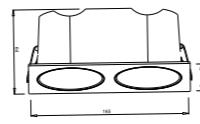

**PARAMETERS**

Name	Model	Watt	Chip	Size(mm)	Cutout	Color	Beam Angle
BL SERIES-SMD	BL-75ST-SMD	(10-15)W*3	(2835)1W*20	240*85*64	230*75	WH+BK	60°

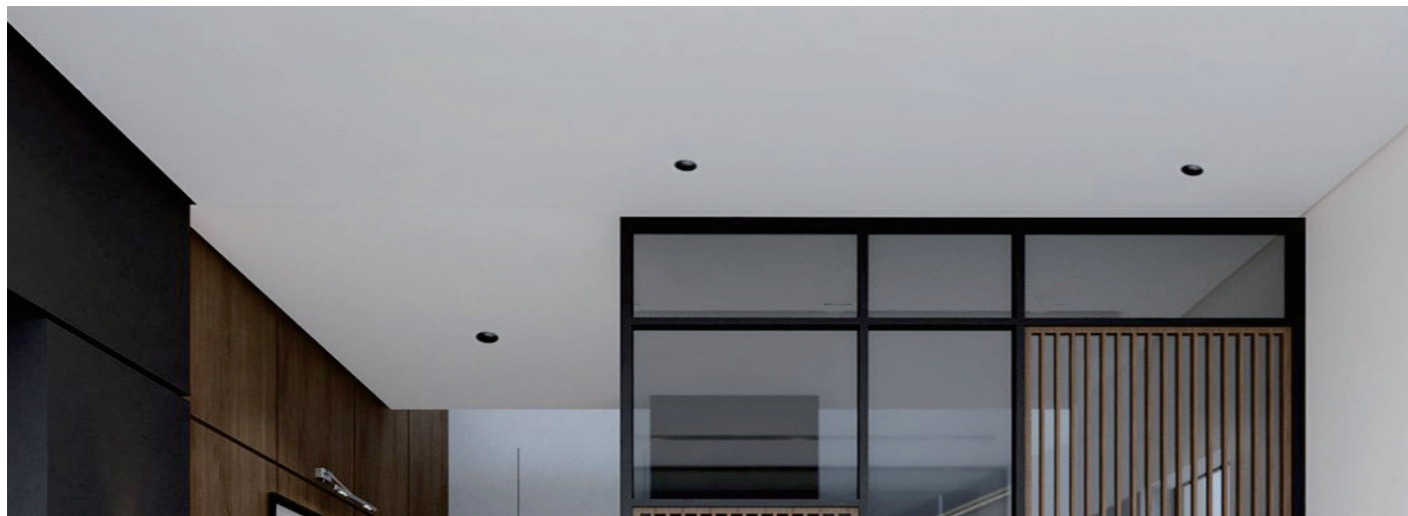
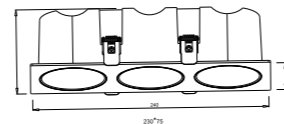

**PARAMETERS**

Name	Model	Watt	Chip	Size(mm)	Cutout	Color	Beam Angle
BL SERIES-SMD	BL-95R-SMD	18-22W	(2835)1W*28	102*74	90	WH+BK	60°

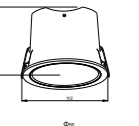

**PARAMETERS**

Name	Model	Watt	Chip	Size(mm)	Cutout	Color	Beam Angle
BL SERIES-SMD	BL-95S-SMD	18-22W	(2835)1W*28	102*102*74	90*90	WH+BK	60°

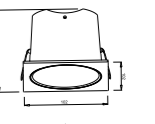

**PARAMETERS**

Name	Model	Watt	Chip	Size(mm)	Cutout	Color	Beam Angle
BL SERIES-SMD	BL-95SD-SMD	(18-22)W*2	(2835)1W*28	220*102*74	205*90	WH+BK	60°

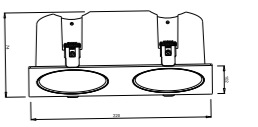



## MS SERIES - LENS



### Product Breakdown Diagram



# LIGHT

Light is everywhere

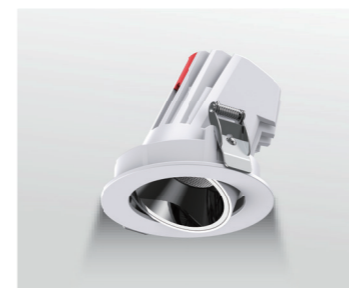
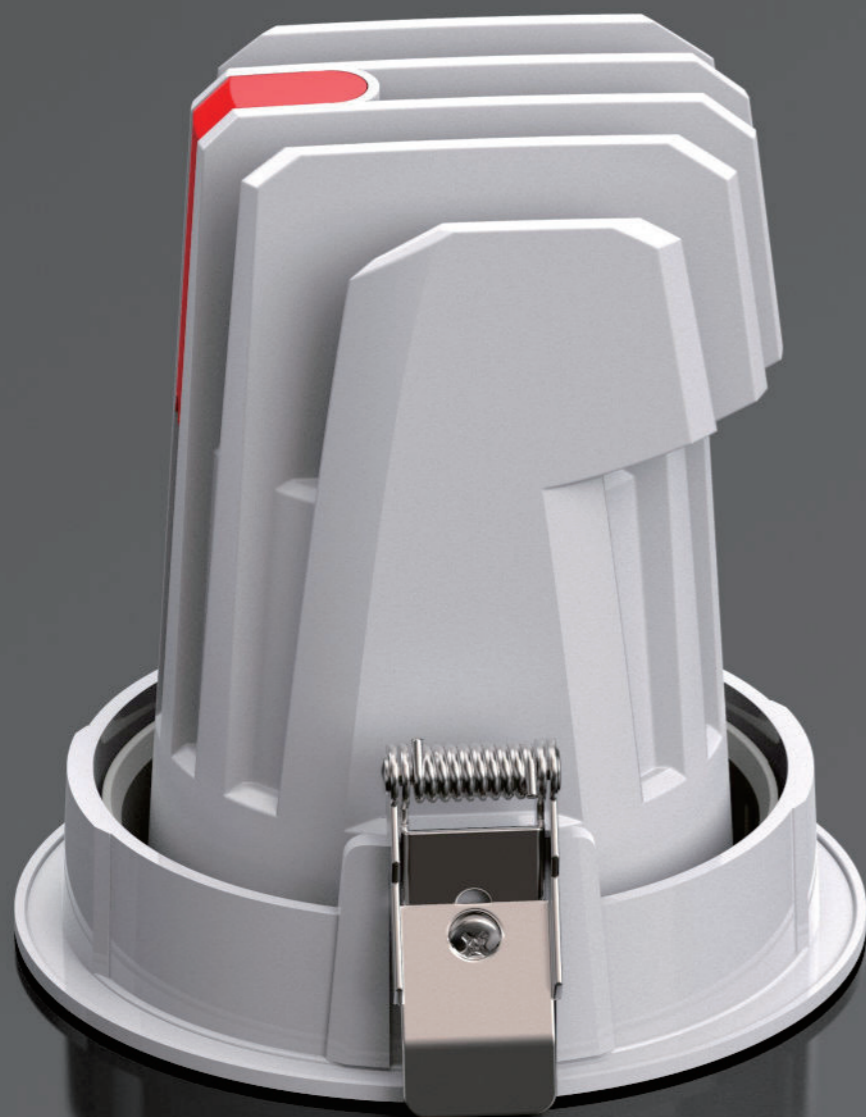

## PARAMETERS

Name	Model	Watt	Chip	Size(mm)	Cutout	Color	Beam Angle
MS SREIES	MS-75	9-12W	1304/020/1507	85*80	75	WH	15°/24°/38°

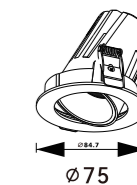

## PARAMETERS

Name	Model	Watt	Chip	Size(mm)	Cutout	Color	Beam Angle
MS SREIES	MS-95	15-20W	1507/020/CXM-9	104*108	95	WH	15°/24°/38°

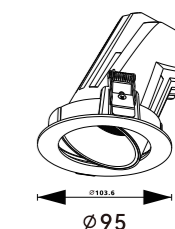

## PARAMETERS

Name	Model	Watt	Chip	Size(mm)	Cutout	Color	Beam Angle
MS SREIES	MS-125	30-33W	1816/030/1507/020	132*127	125	WH	15°/24°/38°

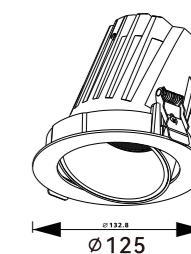

# MZD SERIES



## Application

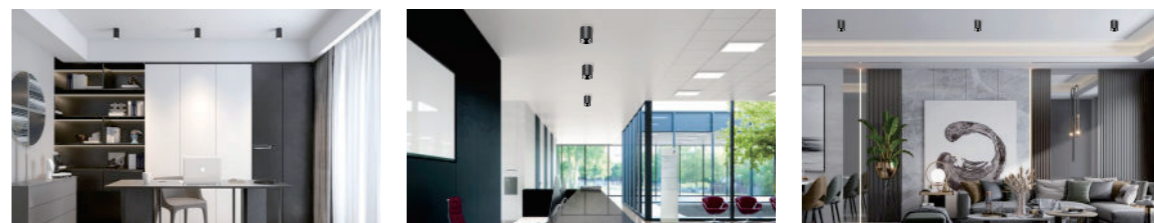

Product Breakdown Diagram

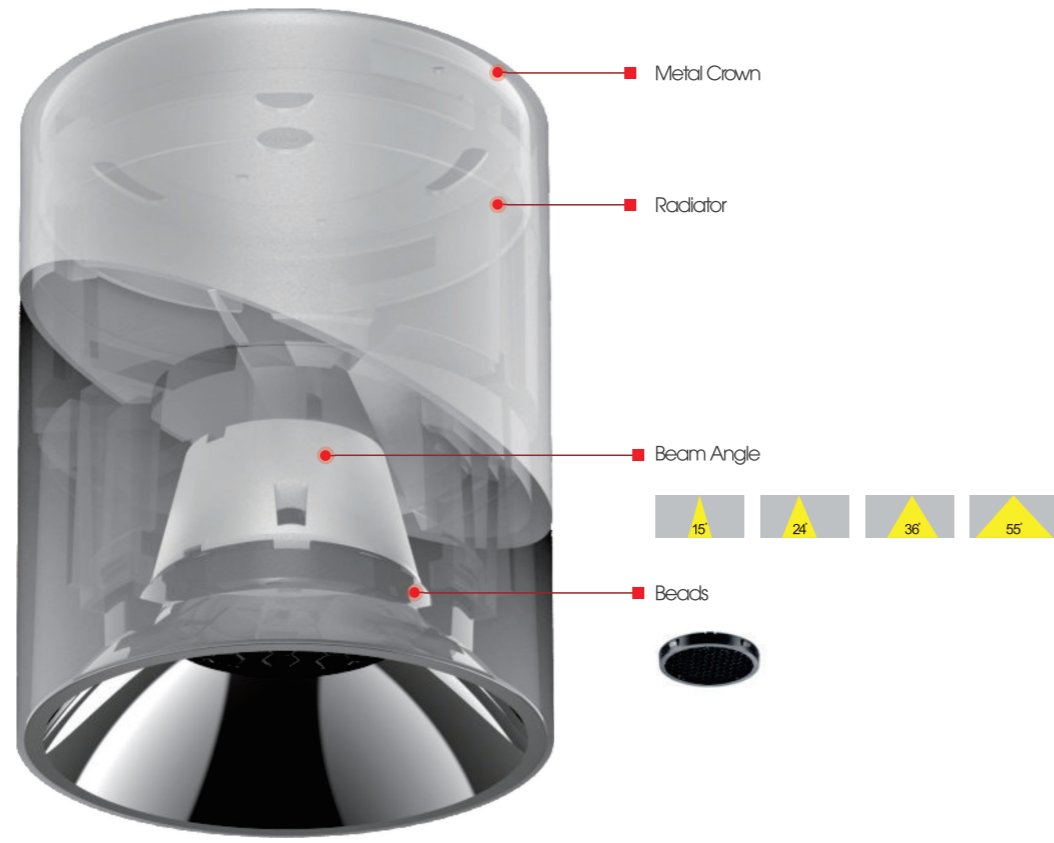

Three-time anti-glare



Details

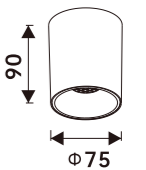

PARAMETERS

Name	Model	Watt	Chip	Size(mm)	Color	Beam Angle
MZD SERIES	MAD-75	8-12W	1304/020/1507	75*90	WH+BK	15°/24°/36°/55°

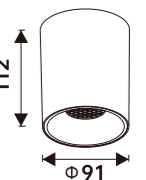

PARAMETERS

Name	Model	Watt	Chip	Size(mm)	Color	Beam Angle
MZD SERIES	MAD-90	18X24W	1507/020/CXM-9	91*112	WH+BK	15°/24°/36°/55°

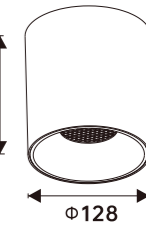

PARAMETERS

Name	Model	Watt	Chip	Size(mm)	Color	Beam Angle
MZD SERIES	MAD-125	25-32W	1814/030/1507/020	128*137	WH+BK	15°/24°/36°/55°



## JG SREIES-REFLECTOR



### Product Breakdown Diagram



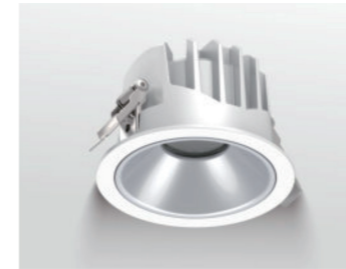

**PARAMETERS**

Name	Model	Watt	Chip	Size(mm)	Cutout	Color	Beam Angle
JG SREIES REFLECTOR	JG-75	7-10W	1304/020/1507	186*55	75	WH+BK	24°/38°/55°

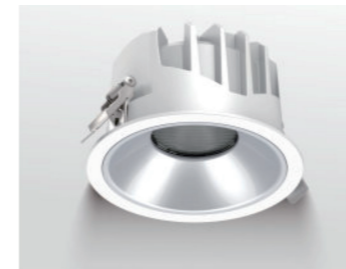
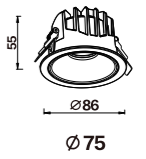

**PARAMETERS**

Name	Model	Watt	Chip	Size(mm)	Cutout	Color	Beam Angle
JG SREIES REFLECTOR	JG-90	15-18W	1507/020/CXM-9	186*55	75	WH+BK	24°/38°/55°

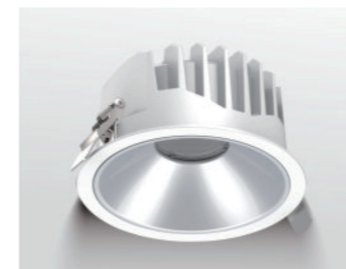
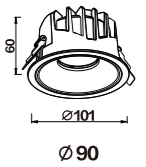

**PARAMETERS**

Name	Model	Watt	Chip	Size(mm)	Cutout	Color	Beam Angle
JG SREIES REFLECTOR	JG-125	25-30W	1814/030/1507/020	140*73	125	WH+BK	24°/38°/55°

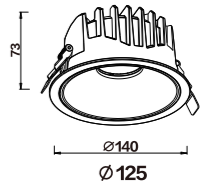

**PARAMETERS**

Name	Model	Watt	Chip	Size(mm)	Cutout	Color	Beam Angle
JG SREIES REFLECTOR	JG-165	35-40W	1820/2520/030	180*94	165	WH+BK	24°/38°/55°

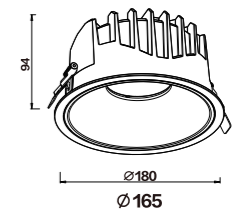

**PARAMETERS**

Name	Model	Watt	Chip	Size(mm)	Cutout	Color	Beam Angle
JG SREIES REFLECTOR	JG-200	50-55W	1820/2520/030	214*110	200	WH+BK	24°/38°/55°

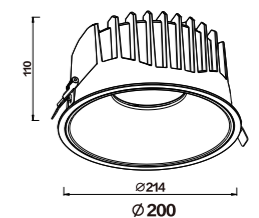

Details

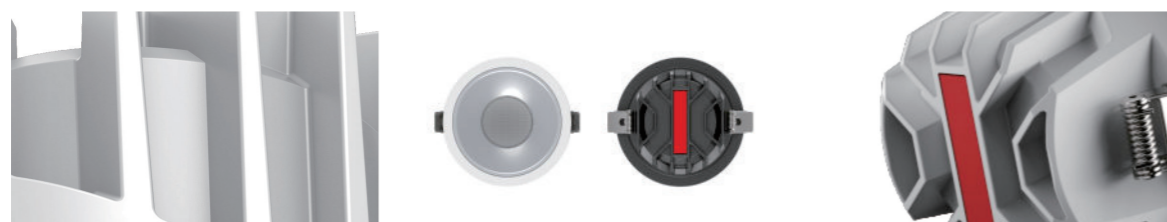



JG SERIES-LENS



Product Breakdown Diagram





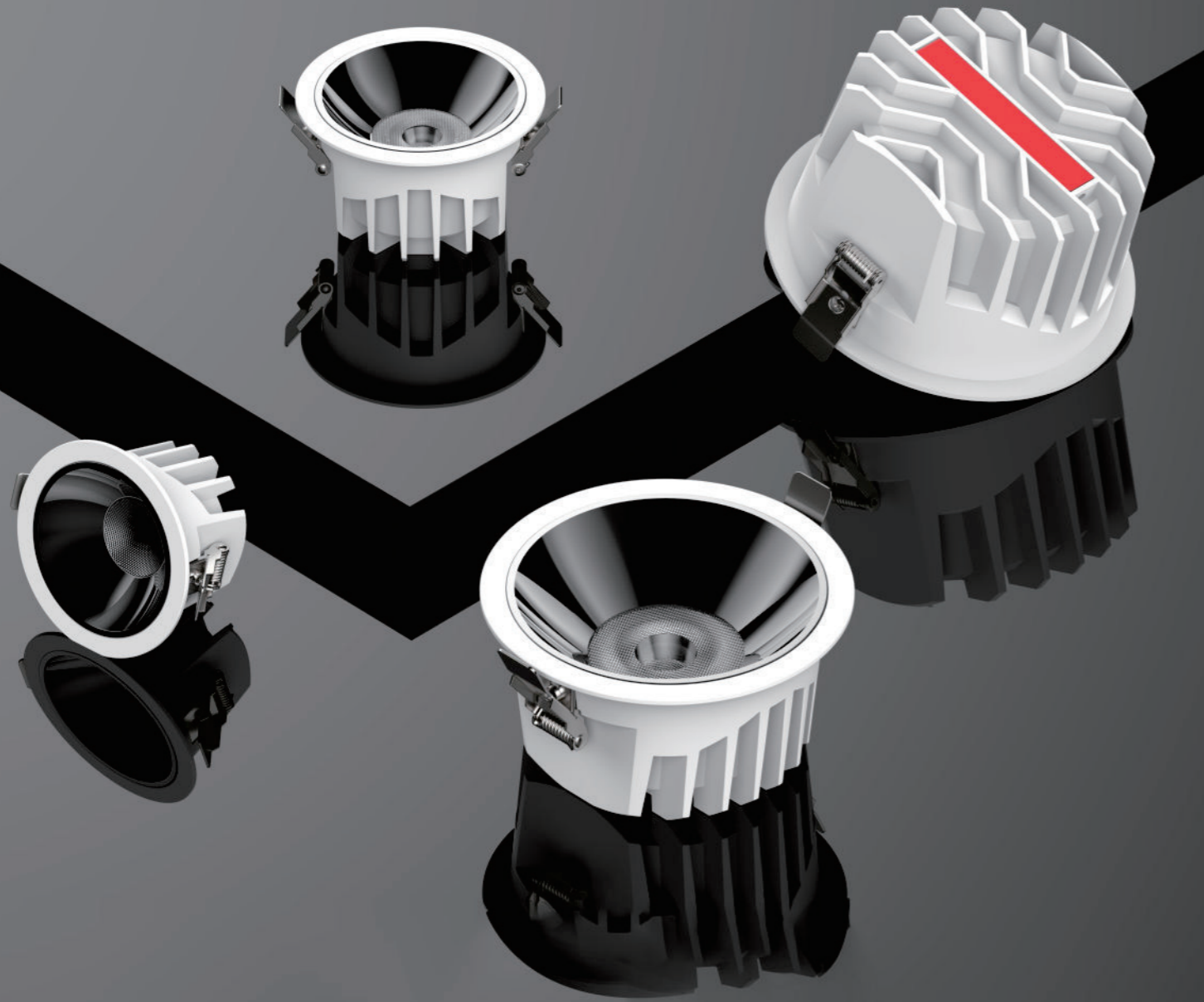

Details

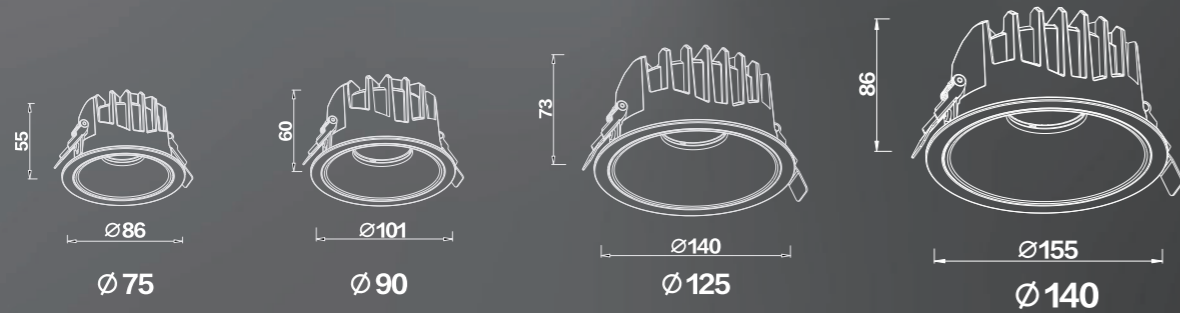

PARAMETERS

Name	Model	Watt	Chip	Size(mm)	Cutout	Color	Beam Angle
JG SREIES-LENS	JG-75	7-10W	1304/020/1507	86*55	75	WH+BK	15°/24°/38°/55°

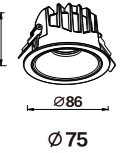

PARAMETERS

Name	Model	Watt	Chip	Size(mm)	Cutout	Color	Beam Angle
JG SREIES-LENS	JG-90	15-18W	1507/020/CXM-9	101*55	75	WH+BK	15°/24°/38°/55°

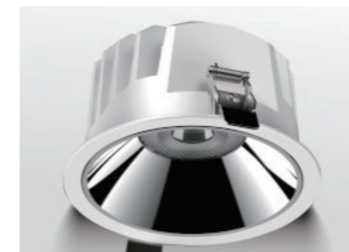
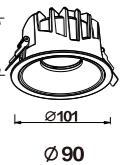

PARAMETERS

Name	Model	Watt	Chip	Size(mm)	Cutout	Color	Beam Angle
JG SREIES-LENS	JG-125	25-30W	1814/030/1507/020	140*73	125	WH+BK	15°/24°/38°/55°

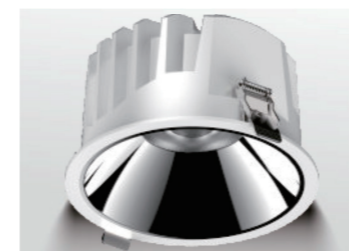
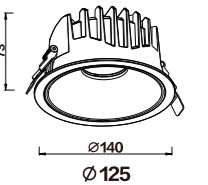

PARAMETERS

Name	Model	Watt	Chip	Size(mm)	Cutout	Color	Beam Angle
JG SREIES-LENS	JG-140	30-35W	1816/030/1507/020	155*86	1405	WH+BK	15°/24°/38°/55°

