

Processing Time Reference Chart

Ingredient	Ingredient volume	Suggested water/ juice/milk volume	Suggested blend time
Carrot	150g/5.3oz	100mL/3.4oz	15~30s
Fruit	100~120g/3.5~4.3oz	100mL/3.4oz	15~30s
Leaf vegetable	120~150g/4.3~5.3oz	100mL/3.4oz	15~30s
Raw meat	150g/5.3oz	100mL/3.4oz	60s

*Please remember to add water/juice/milk for fine puree. Otherwise there might be chunks remain. Water volume and blend time can be different and adjusted for your own preference.

Warning

1. Keep the product away from children.
2. Always unplug before installing or removing components.
3. If product is damaged or missing parts, please contact customer service for help.
4. Do not use other products' blades or accessories. Any damage caused by unauthorized repairment will not be covered by warranty.
5. Make sure the product is connected to 120V-60Hz voltage.
6. Never use the product with damaged cord or plug.
7. Do not put mixing bowl in microwave oven or refrigerator.
8. Never turn on the product without food inside. Do not directly assemble blade set on machine body to avoid injury.
9. If machine stops working during operation, it may be caused by temperature control protection. Please unplug power, and let it cool down for 30 minutes.
10. Unplug power when product is not in using.

Cleaning

1. Please clean and dry mixing bowl, blades, and bowl lid after each use.
2. Do not immerse machine body into water or other liquids. Machine body can only be cleaned by wet wipe.
3. Be careful when cleaning blade set. It is sharp.
4. Do not microwave or boil to sterilize any parts of product.

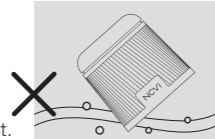

Trouble Shooting

Malfunction	Checking Reason	Solution
Power has been plugged in, but machine doesn't work when press ON/OFF button	Machine body or bowl lid do not in right position	Correct assembled product by aligning groove of bowl lid and machine body
For the first time use, machine has some unpleasant smell	Normal phenomenon for new machine	If product still has unpleasant smell after uses for several times, please contact customer service
Unusual vibration or noise	Blade set is not installed correctly; Product is not on a flat table; Voltage is not 120V; Ingredients in mixing bowl is over maximum capacity	Install blade set correctly; Place product on a stable flat table; Double check voltage; Remove excessive ingredients
Blade is stuck	Blade is stuck by ingredients	Turn of power, disconnect power supply, take out ingredients, cut into smaller pieces
Shut down during use	Voltage is lower than 120V; Machine temperature is too high, triggered control protection	Double check voltage; Let machine cool down for 30 minutes

Note: Above trouble shootings are common problems and solutions. Please contact our customer service ncvi_amz@xenbea.com if you have other problems.

WARRANTY CARD

Thank you for purchasing our product. Please keep your receipt as proof of purchase for any warranty claim.

For warranty claims, please scan QR code.



You can also visit our website
[Https://www.ncvi.co](https://www.ncvi.co) for more information.
 If you have any question,
 please email us at ncvi_amz@xenbea.com.

NOTICE

1. This product comes with 1 YEAR warranty. Please contact the MANUFACTURER for warranty claims.
2. This warranty does not cover defects caused by: misuse, abuse, improper storage/alteration of the product, use of improper components, failure to comply with the operating instructions using the accessories supplied with the product, or normal wear and tear.
3. The user of this product assumes all responsibility and risk for the use of this product.
4. WARNING: No modification of this equipment is allowed.

Jiangsu Xinbei Electrical Appliances Co., Ltd.

Add: No. 115 Xinjin Road, Xinwu District, Wuxi City, Jiangsu Province, China
 Tel: +1(818)291-3826
[Https://www.ncvi.co](https://www.ncvi.co)
 E-MAIL: ncvi_amz@xenbea.com
 Please read the manual carefully before use.
 Please store the product where children can not reach.



Version C-2

NCVI Baby Food Maker

— User Manual —

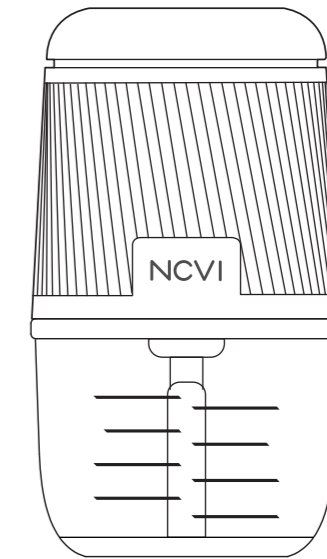

Low Noise · Fine Blending · Easy Control

Product Specification

Name	Baby Food Maker	Model	AM8287-US
Voltage	120V~	Place of Origin	China
Frequency	60Hz	Contains	1 X Food Maker 1 X Brush 1 X Silicone Spatula 1 X Silicone Spoons 2 X Silicone Spoons 1 X Baby Food Container 1 X Baby Food Freezer Tray 1 X Grinding Disc
Power	200W		
Volume	0.3L		

Features

- 300mL small size glass bowl for baby meal
- Crafted from high borosilicate glass for safety
- One-press operation, safe and easy control
- Easy to install, easy to clean
- Low noise, smoothly mixing

Processor Components

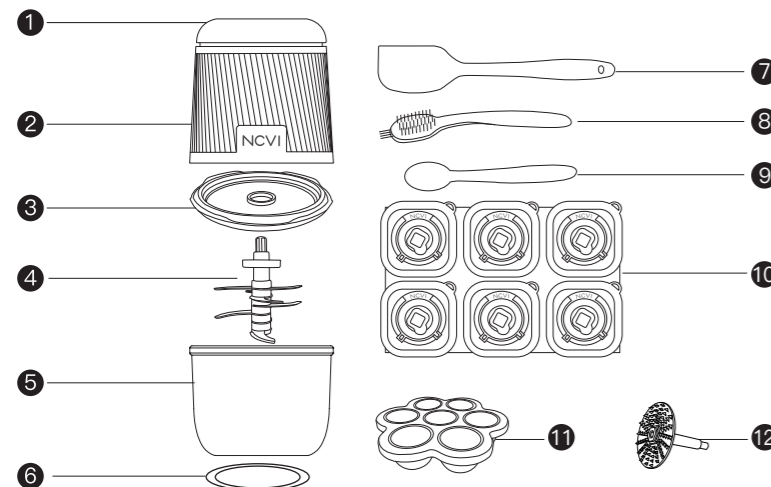

	Name	Function	Material	Operating Temperature	Quantity
1	On/Off	Press & hold to turn on, release to turn off	ABS	/	1
2	Machine Body	Main part of the product, contains motor, provide power for blade	ABS	/	1
3	Mixing Bowl Lid	Cover it on glass bowl for protection and safety	PP	-10°C~120°C 14°F~248°F	1
4	Blade Set	Chopping & mixing & blending	POM	-40°C~120°C -40°F~248°F	1
			SUS304	/	1
5	Mixing Bowl	Place chopped food in the bowl	High Borosilicate Glass	-20°C~150°C -4°F~302°F	1
6	Non-slip Pad	Fixed on mixing bowl to prevent slip	Silicone	-20°C~200°C -4°F~392°F	1
7	Silicone Spatula	Help to take out all pureed food	Silicone	-20°C~200°C -4°F~392°F	1
8	Brush	Clean mixing bowl and blades	PP+Nylon	-10°C/14°F 120°C/248°F	1
9	Silicone Spoon	Feeding Baby	Stainless Steel Silicone	-10°C~120°C 14°F~248°F	2
10	Baby Food Container	Storage pureed food, freezer safe	PP	-10°C~120°C 14°F~248°F	1
11	Baby Food Freezer Tray	Storage pureed food, freezer safe	Silicone	-20°C~200°C -4°F~392°F	1
12	Grinding Disc	Grinding	PP	-10°C~120°C 14°F~248°F	1

How to Install and Use

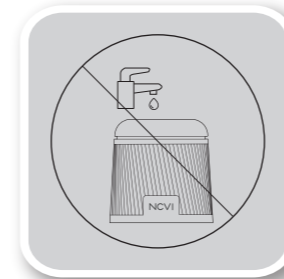

1. Clean all parts that will contact food. **DO NOT** immerse machine body into water.

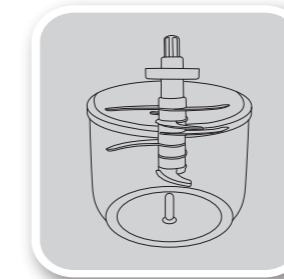

2. Place **MIXING BOWL** on a flat table, insert **BLADE SET** on the fixed shaft of the mixing bowl.

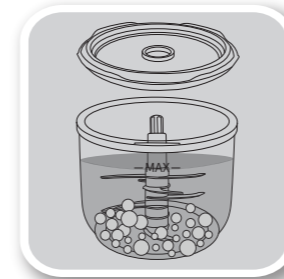

3. Put steamed & chopped fruit/veg/cereals or raw meat pieces into the **MIXING BOWL**, and add enough water/juice/milk (see **PROCESSING TIME REFERENCE CHART**). Make sure **BLADE SET** sits straight on shaft, then close **MIXING BOWL LID**.



4. Put machine body on the mixing bowl lid and fix it. The machine only can be turned on when machine body is correctly positioned.



5. **PLUG IN** power, press and hold **ON/OFF** button, then blade will start to spin. Machine will stop when release **ON/OFF** button.

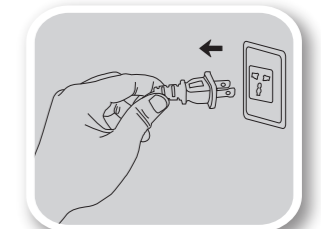

6. After blades stopped rotating, **UNPLUG POWER FIRST**, then use spatula take out pureed food.

Warning

- * It is recommended that continuous working time should not exceed 30 seconds. You can release **ON/OFF** button, then press & hold again after for a break every 30 seconds. If food is not delicate enough after processing for 300 seconds, please wait for 2 minutes wait for machine to cool down then start to blend again.
- * If ingredients stick to mixing bowl, please release button, disconnect power, scrape ingredients off with silicone spatula, then process again.
- * If product shakes due to uneven distribution of ingredients, please release button, disconnect power, scrape and put ingredients evenly with silicone spatula, then process again.

Instruction of Preparing Food Before Blending

1. Preparing raw meat: **Blending first then Steaming**. Remove tendons, bones, and skin of raw meat, cut it into small pieces (0.4in*0.4in cube), put chopped raw meat and appropriate amount of water/juice/milk into mixing bowl for blending (do not exceed "Max" line). Then steaming the pureed meat.
2. Prepare vegetables/fruits/cereals: **Steaming first then Blending**. Steaming vegetable/fruit first, then cut it into small pieces (0.4in*0.4in cube), put chopped vegetable/fruit and appropriate amount of water/juice/milk into mixing bowl for blending (do not exceed "Max" line).
3. This machine cannot be used to grind excessively hard ingredients (such as soybean, rice, frozen meat, etc).