

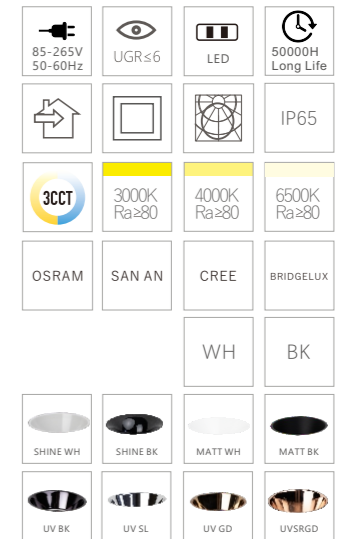

XG-CD2302

TECHNICAL SPECIFICATIONS

Product Name :	COB Downlight
Model no:	XG-CD2302
Power :	7W/12W/15W/20W/24W/36W/40W
Input :	AC85-265V , 50 /60 HZ
Temperature range :	-20-50°C
Light source :	COB
Lumen :	80-110 LM/W
Colour Temperture :	3000K - 6500K/CCT
Colour Rendering Index :	CRI>80
Beam angle :	15°/24°/36°
Power factor :	Pf>0.5 / Pf>0.9
Power efficiency :	92%
Housing material :	Die-casting Aluminium
Optical material:	Reflective cup+Lens
Lighning protection :	1.5-4KV
Protection class :	Ip20

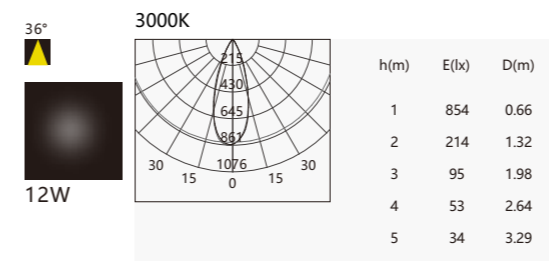
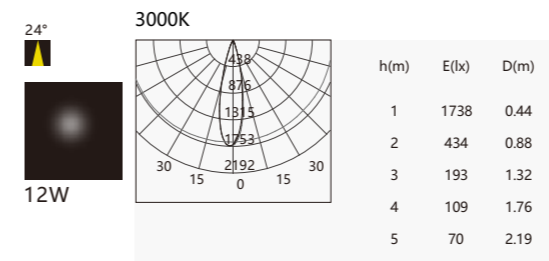
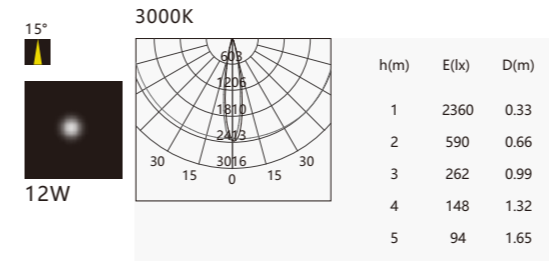
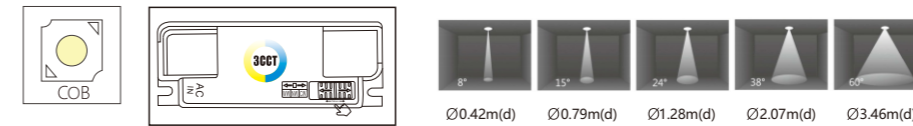

MODEL :
XG-CD2302-7W

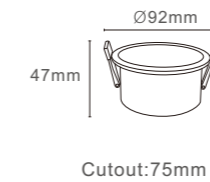

MODEL :
XG-CD2302-12W/15W

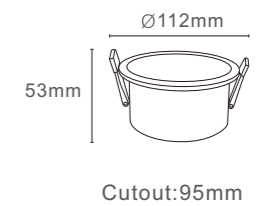

MODEL :
XG-CD2302-20-24W

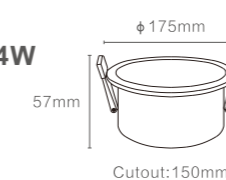

MODEL :
XG-CD2302-36-40W

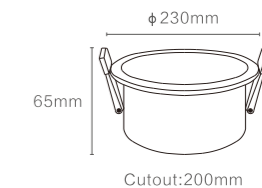



CD-2210

TECHNICAL SPECIFICATIONS

Product Name :	COB Downlight
Model no:	CD-2210
Power :	5W/12W
Input :	AC85-265V , 50 /60 HZ
Temperature range :	-20-50°C
Light source :	COB
Lumen :	80-110 LM/W
Colour Temperature :	3000K - 6500K/CCT
Colour Rendering Index :	CRI>80
Beam angle :	15°/24°/36°
Power factor :	Pf>0.5 / Pf>0.9
Power efficiency :	92%
Housing material :	Die-casting Aluminium
Optical material:	Reflective cup
Lighning protection :	1.5-4KV
Protection class :	Ip20



CD-2210 SERIES

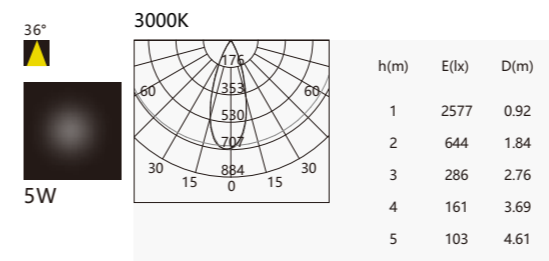
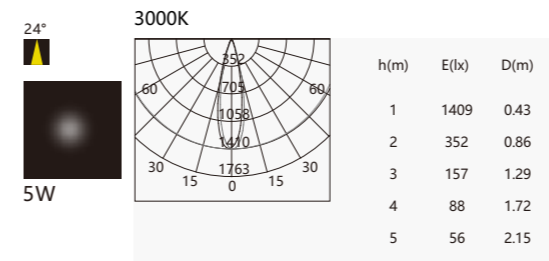
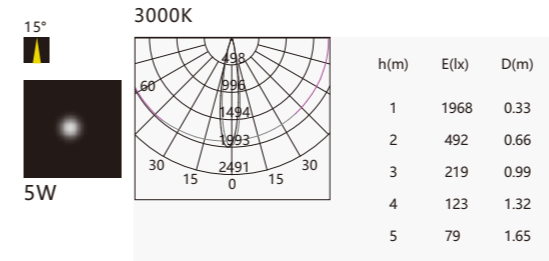
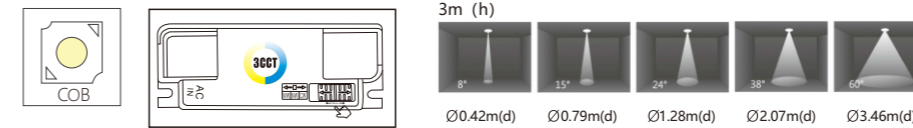

85-265V 50-60Hz	UGR≤6	LED	50000H Long Life
IP20	IP20	IP20	IP20
3CCT	3000K Ra>80	4000K Ra>80	6500K Ra>80
OSRAM	SAN AN	CREE	BRIDGELUX
	WH	BK	
	SAND WH	SAND BK	

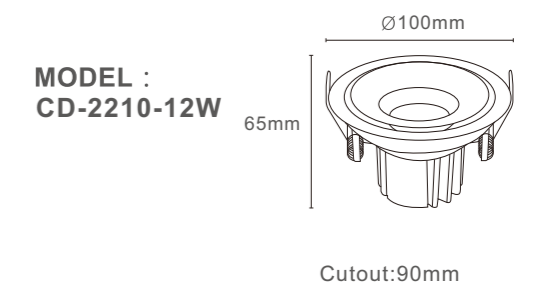
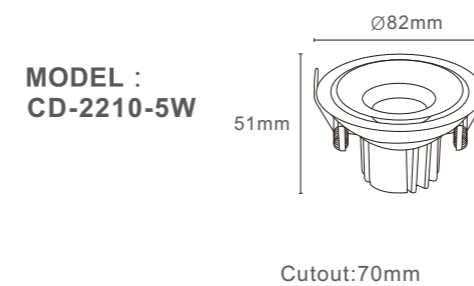



CD-2320

TECHNICAL SPECIFICATIONS

Product Name :	COB Downlight
Model no:	CD-2320
Power :	5W/7W/12W/10W/24W/18W
Input :	AC85-265V , 50 /60 HZ
Temperature range :	-20-50°C
Light source :	COB
Lumen :	80-110 LM/W
Colour Temperature :	3000K - 6500K/CCT
Colour Rendering Index :	CRI>80
Beam angle :	10°/20°/30°
Power factor :	Pf>0.5 / Pf>0.9
Power efficiency :	92%
Housing material :	Die-casting Aluminium
Optical material:	Lens
Lighning protection :	1.5-4KV
Protection class :	Ip20



CD-2320 SERIES

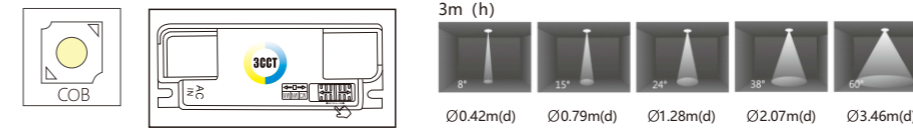

85-265V 50-60Hz	UGR≤6	LED	50000H Long Life
IP20	3000K Ra>80	4000K Ra>80	6500K Ra>80
OSRAM	SAN AN	CREE	BRIDGELUX
	WH	BK	

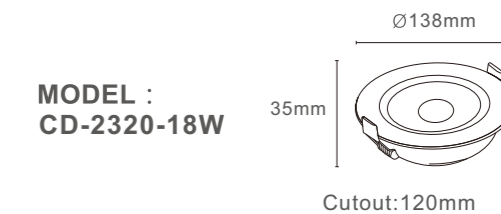
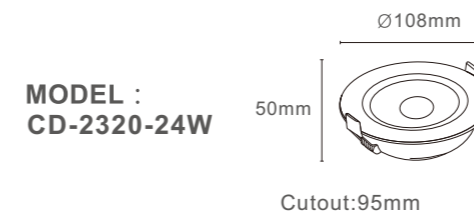
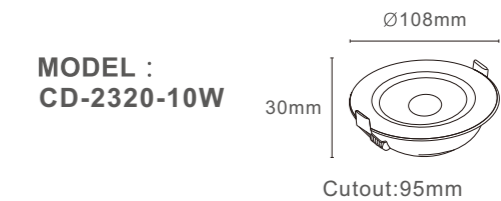
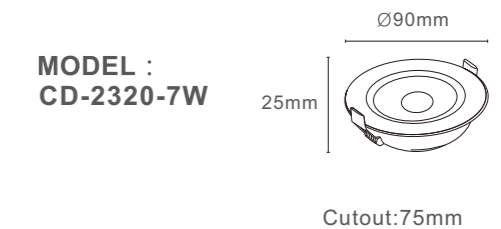
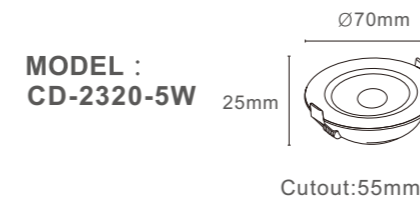
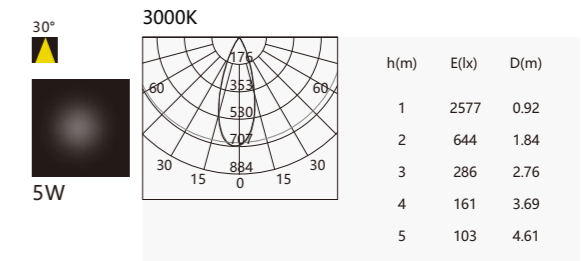
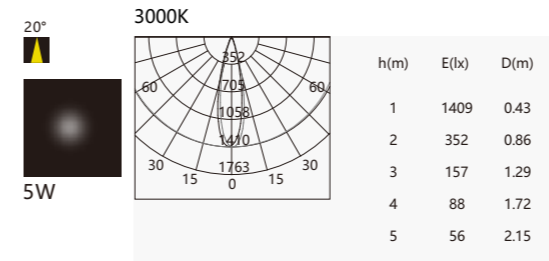
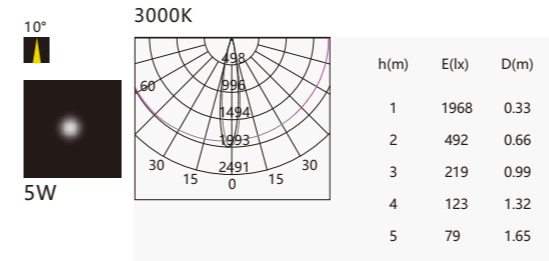



CD-2330

TECHNICAL SPECIFICATIONS

Product Name :	COB Downlight
Model no:	CD-2330
Power :	7W/7W/12W/18W
Input :	AC85-265V , 50 /60 HZ
Temperature range :	-20-50°C
Light source :	COB
Lumen :	80-110 LM/W
Colour Temperature :	3000K - 6500K/CCT
Colour Rendering Index :	CRI>80
Beam angle :	8°15°24°38°55°
Power factor :	Pf>0.5 / Pf>0.9
Power efficiency :	92%
Housing material :	Die-casting Aluminium
Optical material:	Reflective cup+Lens
Lighning protection :	1.5-4KV
Protection class :	Ip20



CD-2330 SERIES

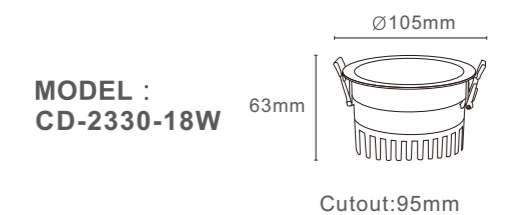
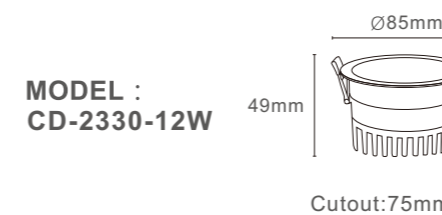
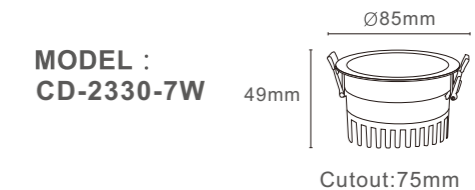
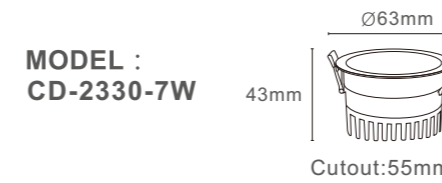
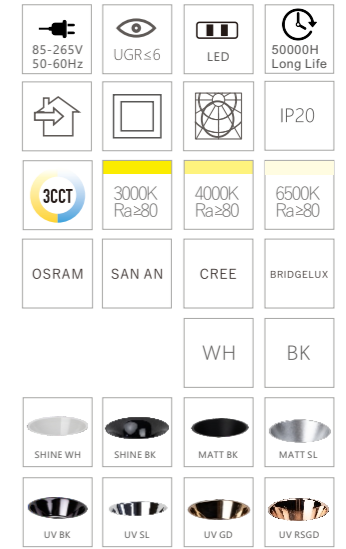
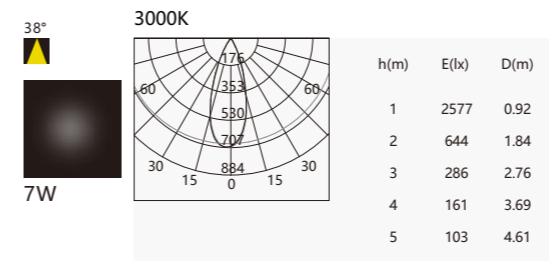
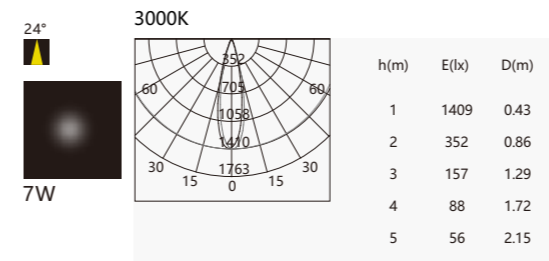
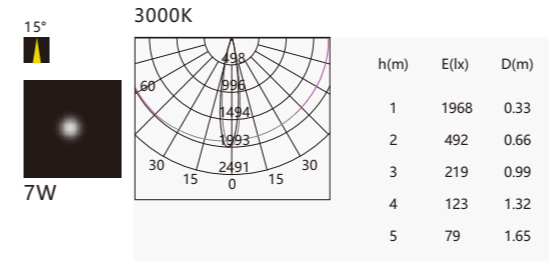
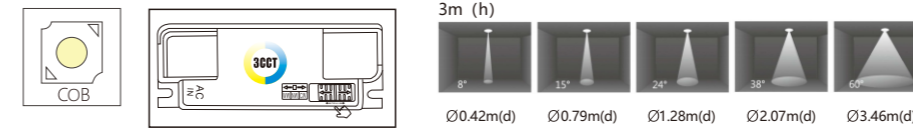



CD-2331

TECHNICAL SPECIFICATIONS

Product Name :	COB Downlight
Model no:	CD-2331
Power :	5W/7W/10W/15W
Input :	AC85-265V , 50 /60 HZ
Temperature range :	-20-50°C
Light source :	COB
Lumen :	80-110 LM/W
Colour Temperature :	3000K - 6500K/CCT
Colour Rendering Index :	CRI>80
Beam angle :	15°/24°/36°/60°
Power factor :	Pf>0.5 / Pf>0.9
Power efficiency :	92%
Housing material :	Die-casting Aluminium
Optical material:	Reflective cup+Lens
Lighning protection :	1.5-4KV
Protection class :	Ip20



CD-2331 SERIES

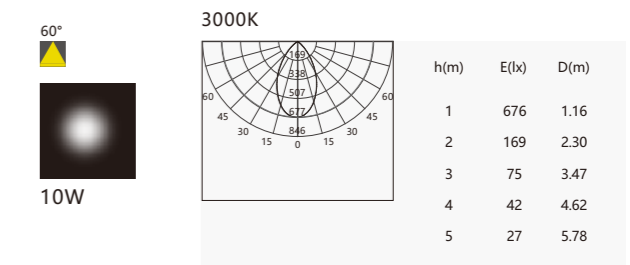
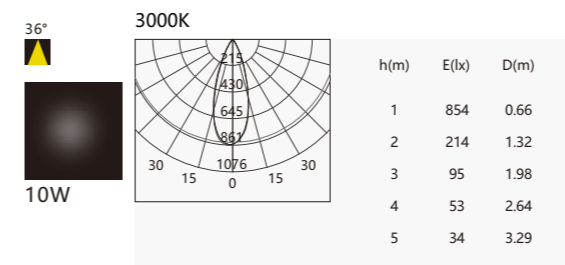
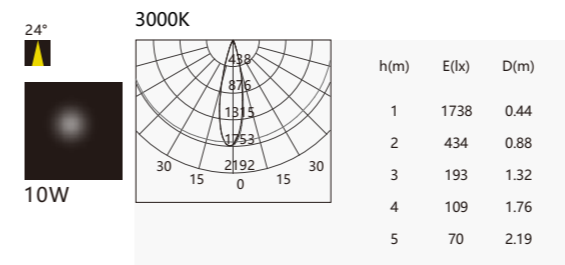
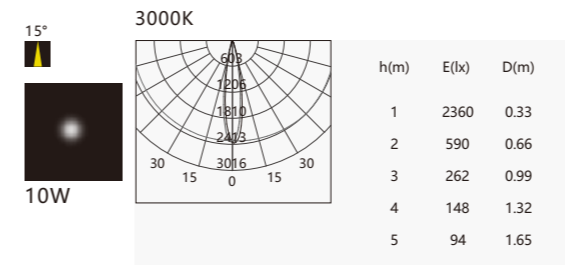
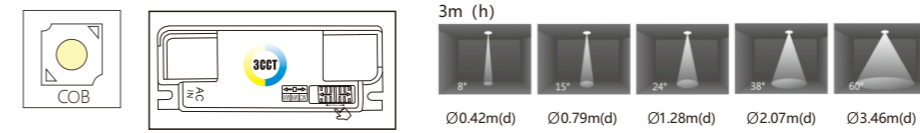

85-265V 50-60Hz	UGR≤6	LED	50000H Long Life
IP20	IP20	IP20	IP20
3000K Ra>80	4000K Ra>80	6500K Ra>80	
OSRAM	SAN AN	CREE	BRIDGELUX
	WH	BK	
	SHINE WH	SHINE BK	
	UV BK	UV SL	UV GD

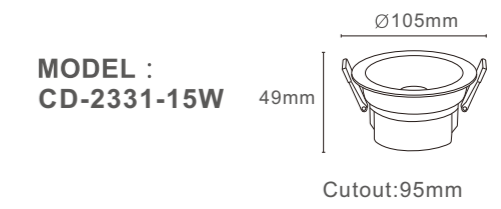
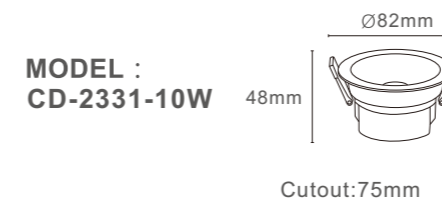
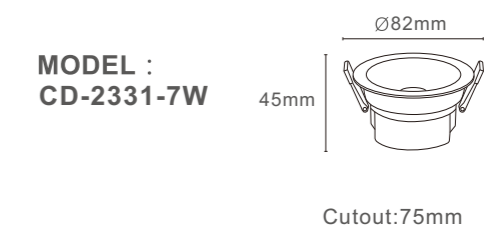
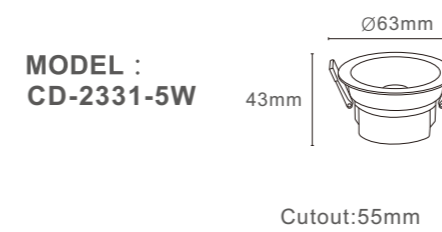



CD-2332

TECHNICAL SPECIFICATIONS

Product Name :	COB Downlight
Model no:	CD-2332
Power :	7W/2*7W/2*12W/2*15W
Input :	AC85-265V , 50 /60 HZ
Temperature range :	-20-50°C
Light source :	COB
Lumen :	80-110 LM/W
Colour Temperature :	3000K - 6500K/CCT
Colour Rendering Index :	CRI>80
Beam angle :	15°/24°/36°
Power factor :	Pf>0.5 / Pf>0.9
Power efficiency :	92%
Housing material :	Die-casting Aluminium
Optical material:	Reflective cup+Lens
Lighning protection :	1.5-4KV
Protection class :	Ip20

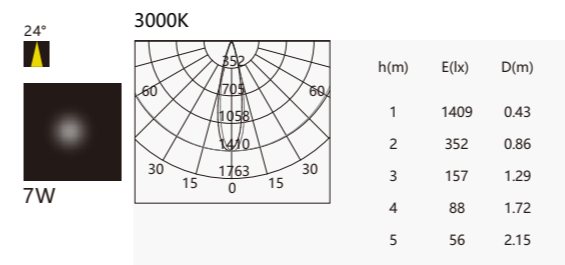
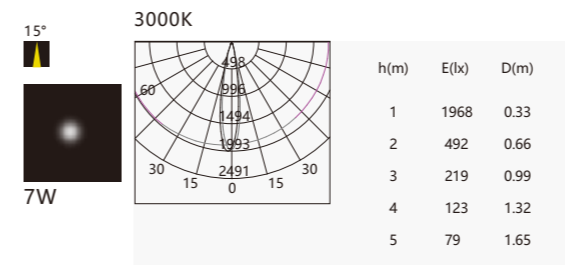
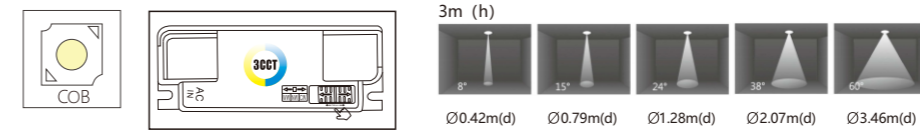

85-265V 50-60Hz	UGR≤6	LED	50000H Long Life
IP20	3000K Ra>80	4000K Ra>80	6500K Ra>80
OSRAM	SAN AN	CREE	BRIDGELUX
	WH	BK	
	SHINE WH	SHINE BK	
UV BK	UV SL	UV GD	UV RSGD

MODEL :
CD-2332-7W/12W/15W
Cutout:75mm

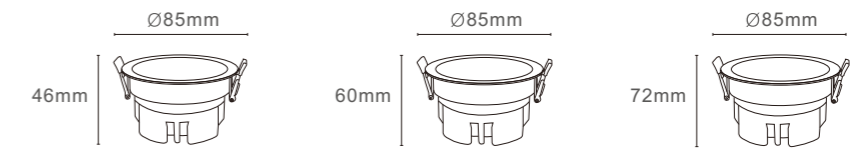

MODEL :
CD-2332-7W/12W/15W
Cutout:75mm

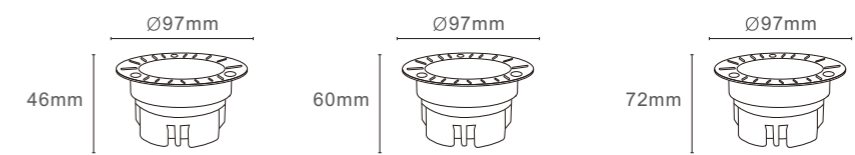

MODEL :
CD-2332-7W/12W/15W
Cutout:75mm

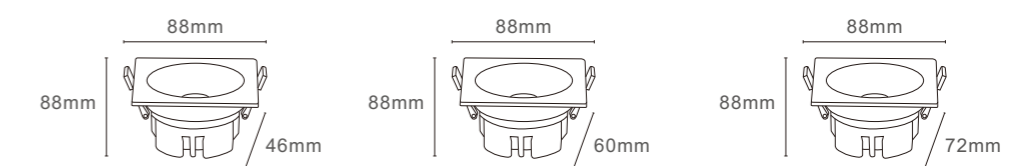

MODEL :
**CD-2332-2*7W/2*12W/
2*15W**
Cutout:160*75mm

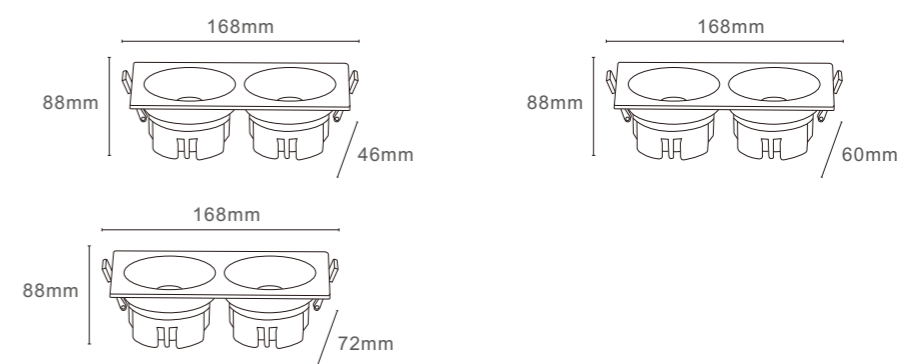



CD-2340

TECHNICAL SPECIFICATIONS

Product Name :	COB Downlight
Model no:	CD-2340
Power :	12W/18W
Input :	AC85-265V , 50 /60 HZ
Temperature range :	-20-50°C
Light source :	COB
Lumen :	80-110 LM/W
Colour Temperature :	3000K - 6500K/CCT
Colour Rendering Index :	CRI>80
Beam angle :	13°/15°/24°/38°/60°
Power factor :	Pf>0.5 / Pf>0.9
Power efficiency :	92%
Housing material :	Die-casting Aluminium
Optical material:	Reflective cup+Lens
Lighning protection :	1.5-4KV
Protection class :	Ip20

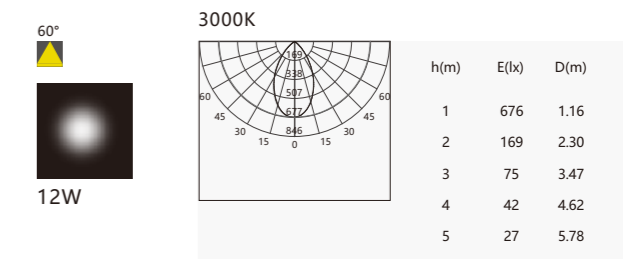
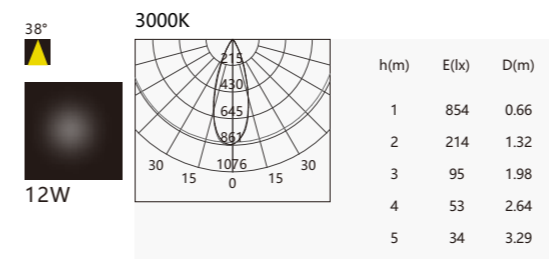
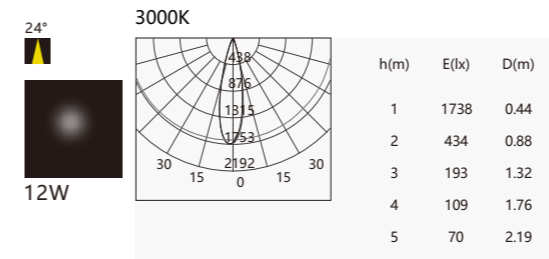
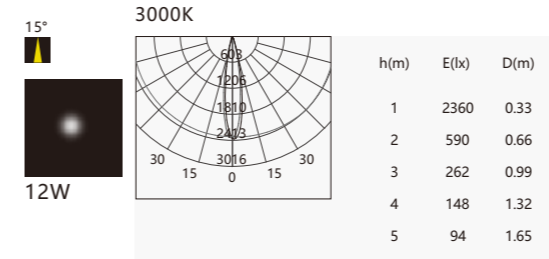
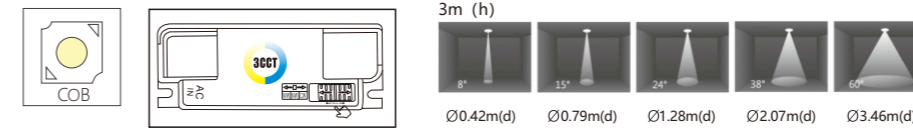

85-265V 50-60Hz	UGR≤6	LED	50000H Long Life
IP20	3000K Ra>80	4000K Ra>80	6500K Ra>80
OSRAM	SAN AN	CREE	BRIDGELUX
	WH	BK	
SHINE WH	SHINE BK	MATT WH	MATT BK
UV BK	UV SL	UV GD	UV RSGD

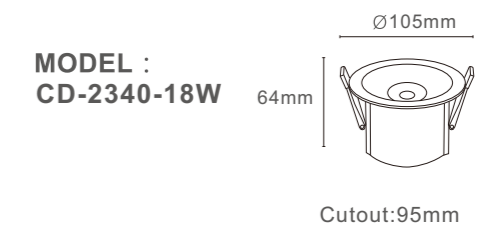
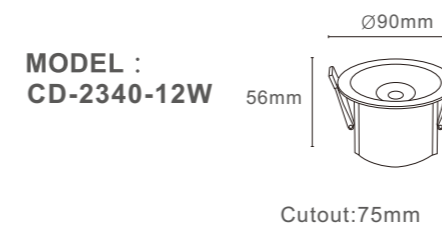

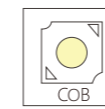

3m (h)

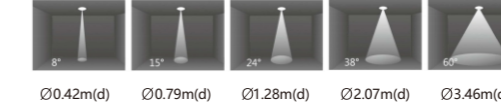

Ø0.42m(d) Ø0.79m(d) Ø1.28m(d) Ø2.07m(d) Ø3.46m(d)

15°

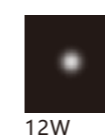

3000K

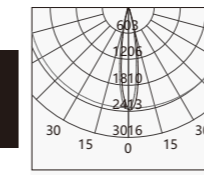

h(m)	E(lx)	D(m)
1	2360	0.33
2	590	0.66
3	262	0.99
4	148	1.32
5	94	1.65

12W

24°



3000K

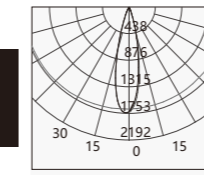

h(m)	E(lx)	D(m)
1	1738	0.44
2	434	0.88
3	193	1.32
4	109	1.76
5	70	2.19

12W

36°



3000K

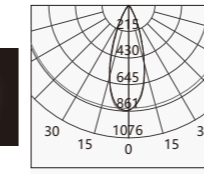

h(m)	E(lx)	D(m)
1	854	0.66
2	214	1.32
3	95	1.98
4	53	2.64
5	34	3.29

12W

55°



3000K

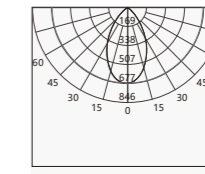

h(m)	E(lx)	D(m)
1	676	1.16
2	169	2.30
3	75	3.47
4	42	4.62
5	27	5.78

12W

CD-2341

TECHNICAL SPECIFICATIONS

Product Name :	COB Downlight
Model no:	CD-2341
Power :	7W/12W/18W/20W
Input :	AC85-265V , 50 /60 HZ
Temperature range :	-20-50°C
Light source :	COB
Lumen :	80-110 LM/W
Colour Temperature :	3000K - 6500K/CCT
Colour Rendering Index :	CRI>80
Beam angle :	15°/24°/36°/55°
Power factor :	Pf>0.5 / Pf>0.9
Power efficiency :	92%
Housing material :	Die-casting Aluminium
Optical material:	Reflective cup+Lens
Lighning protection :	1.5-4KV
Protection class :	Ip20



MODEL :
CD-2341-7W

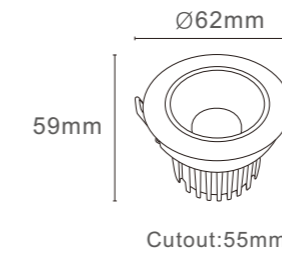

MODEL :
CD-2341-12W

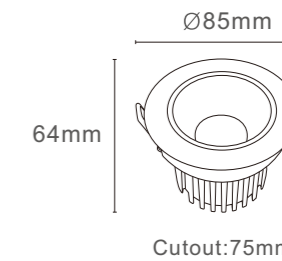

MODEL :
CD-2341-18W

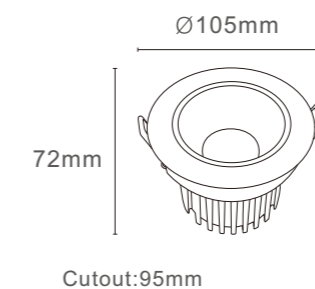

MODEL :
CD-2341-20W

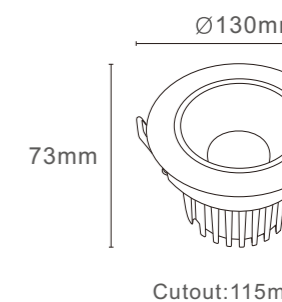



CD-2342 SERIES

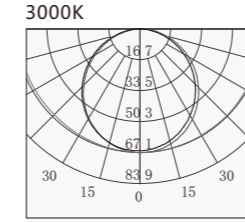
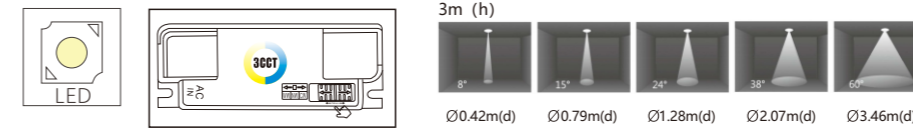

h(m)	E(lx)	D(m)
1	672	2.94
2	168	5.89
3	75	8.83
4	42	11.78
5	27	14.72

85-265V 50-60Hz	UGR≤6	LED	50000H Long Life
IP20	3 CCT	3000K Ra>80	4000K Ra>80
OSRAM	SAN AN	CREE	BRIDGELUX
		WH	BK
SHINE WH	SHINE BK	MATT WH	MATT BK
UV BK	UV SL	UV GD	UV RSGD

CD-2342

TECHNICAL SPECIFICATIONS

Product Name :	SMD Downlight
Model no:	CD-2342
Power :	7W/12W/18W
Input :	AC85-265V , 50 /60 HZ
Temperature range :	-20-50°C
Light source :	SMD2835
Lumen :	80-110 LM/W
Colour Temperature :	3000K - 6500K/CCT
Colour Rendering Index :	CRI>80
Beam angle :	120°
Power factor :	Pf>0.5 / Pf>0.9
Power efficiency :	92%
Housing material :	Die-casting Aluminium
Diffuser:	PS(Polystyrene)
Lighning protection :	1.5-4KV
Protection class :	Ip20

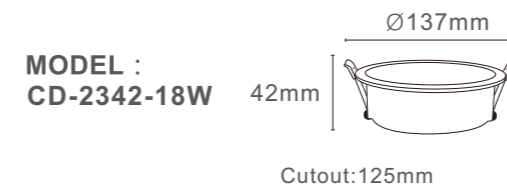
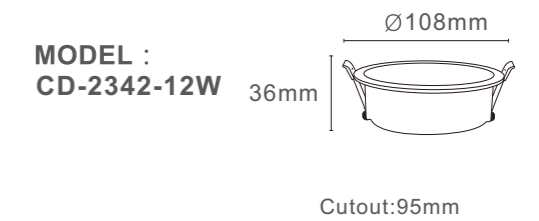
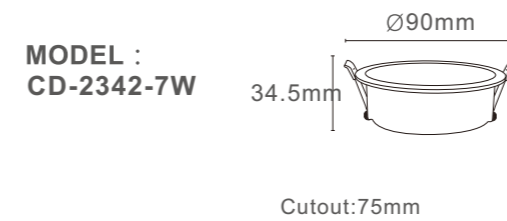



CD-2343 SERIES

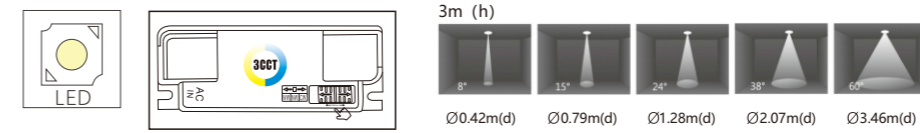

85-265V 50-60HZ	UGR≤6	LED	50000H Long Life
IP20	IP20	IP20	IP20
3CCT	3000K Ra>80	4000K Ra>80	6500K Ra>80
OSRAM	SAN AN	CREE	BRIDGELUX
	WH	BK	
SHINE WH	SHINE BK	MATT WH	MATT BK
UV BK	UV SL	UV GD	UV RSGD

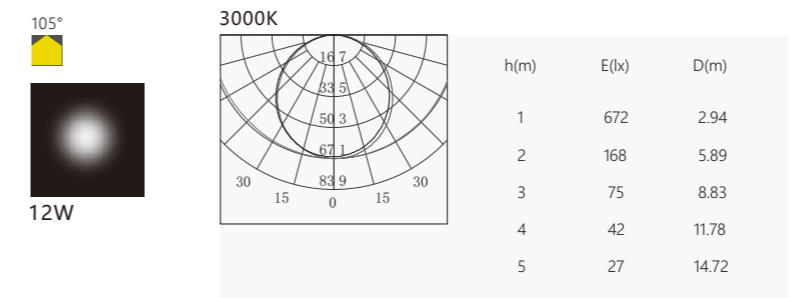

CD-2343

TECHNICAL SPECIFICATIONS

Product Name :	SMD Downlight
Model no:	CD-2343
Power :	5W/10W/12W/15W/18W/24W/30W/ 48W
Input :	AC85-265V , 50 /60 HZ
Temperature range :	-20-50°C
Light source :	SMD2835
Lumen :	80-110 LM/W
Colour Temperture :	3000K - 6500K/CCT
Colour Rendering Index :	CRI>80
Beam angle :	105°
Power factor :	Pf>0.5 / Pf>0.9
Power efficiency :	92%
Housing material :	Die-casting Aluminium
Optical material:	Reflective cup+PS Diffuser
Lighning protection :	1.5-4KV
Protection class :	Ip20

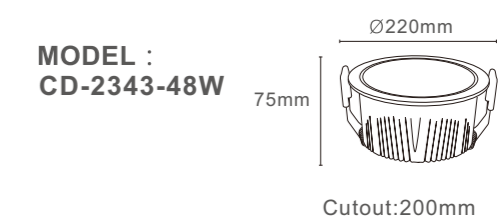
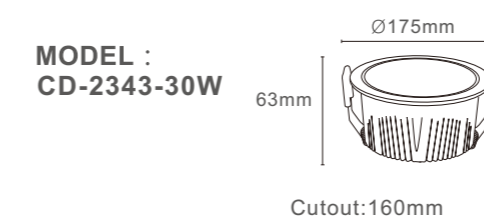
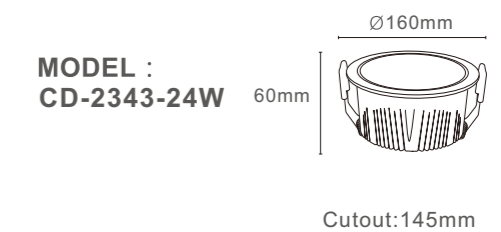
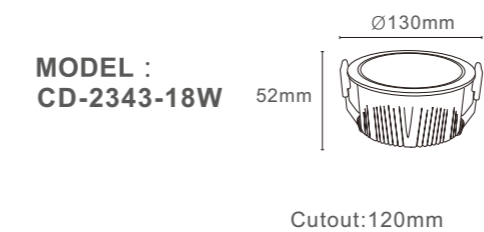
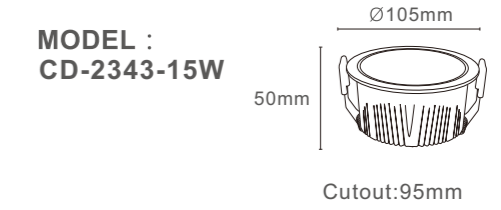
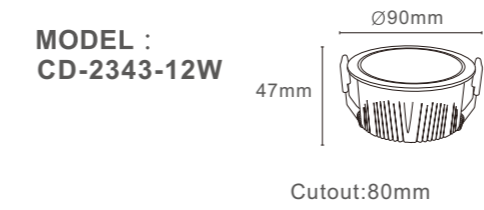
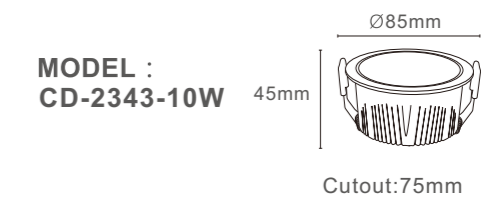
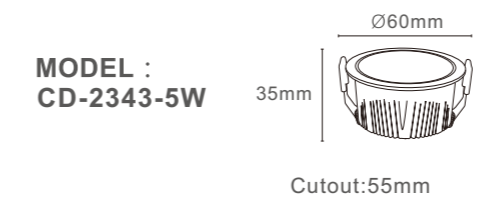



CD-2344 SERIES

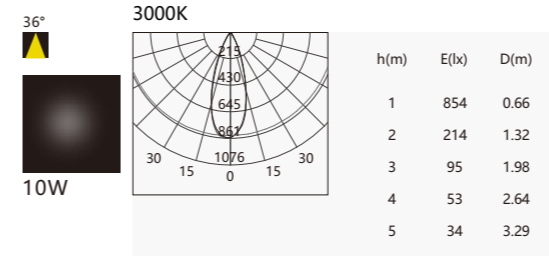
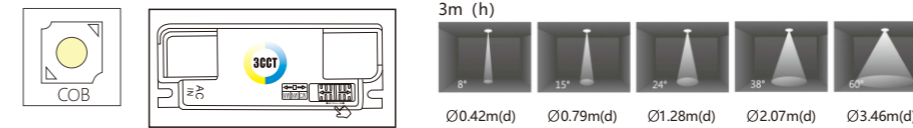

85-265V 50-60HZ	UGR≤6	LED	50000H Long Life
IP20	IP20	IP20	IP20
3000K Ra>80	4000K Ra>80	6500K Ra>80	
OSRAM	SAN AN	CREE	BRIDGELUX
	WH	BK	
SHINE WH	SHINE BK	MATT WH	MATT BK
UV BK	UV SL	UV GD	UV RSGD

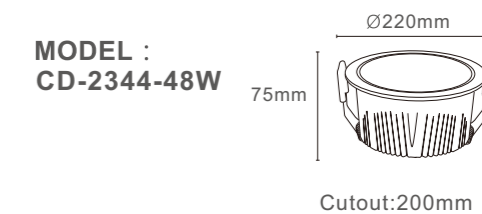
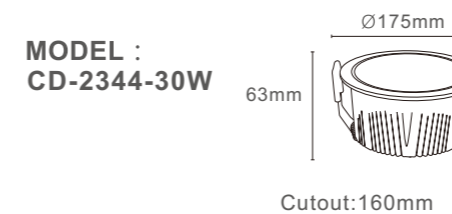
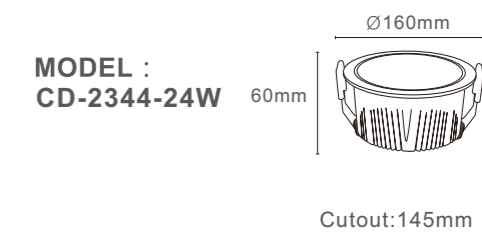
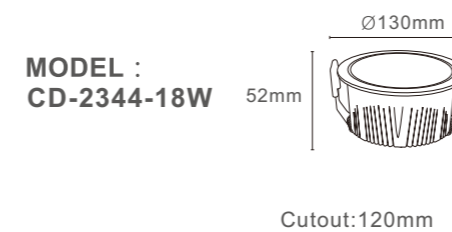
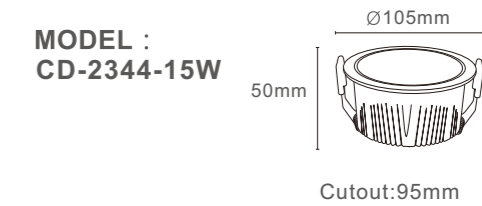
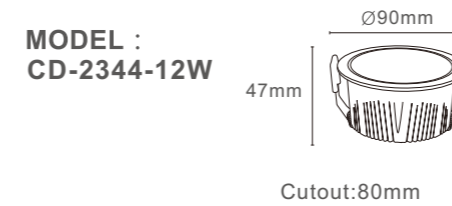
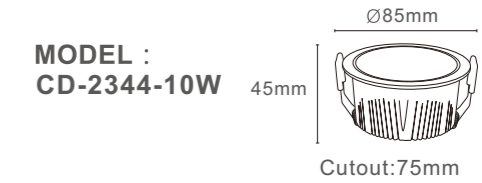

CD-2344

TECHNICAL SPECIFICATIONS

Product Name :	COB Downlight
Model no:	CD-2344
Power :	5W/10W/12W/15W/18W/24W/30W/ 48W
Input :	AC85-265V , 50 /60 HZ
Temperature range :	-20-50°C
Light source :	COB
Lumen :	80-110 LM/W
Colour Temperture :	3000K - 6500K/CCT
Colour Rendering Index :	CRI>80
Beam angle :	15°/24°/36°/60°
Power factor :	Pf>0.5 / Pf>0.9
Power efficiency :	92%
Housing material :	Die-casting Aluminium
Optical material:	Reflective cup+Lens
Lighning protection :	1.5-4KV
Protection class :	Ip20





CD-2345

TECHNICAL SPECIFICATIONS

Product Name :	COB Downlight
Model no:	CD-2345
Power :	5W/7W/15W
Input :	AC85-265V , 50 /60 HZ
Temperature range :	-20-50°C
Light source :	COB
Lumen :	80-110 LM/W
Colour Temperature :	3000K - 6500K/CCT
Colour Rendering Index :	CRI>80
Beam angle :	15°/24°/36°
Power factor :	Pf>0.5 / Pf>0.9
Power efficiency :	92%
Housing material :	Die-casting Aluminium
Optical material:	Reflective cup+Lens
Lighning protection :	1.5-4KV
Protection class :	Ip20

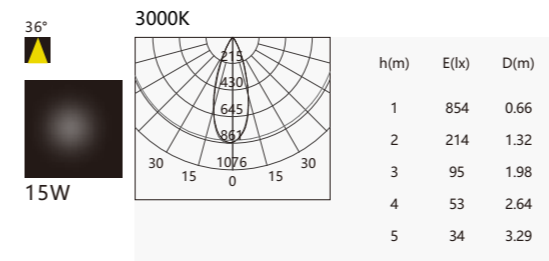
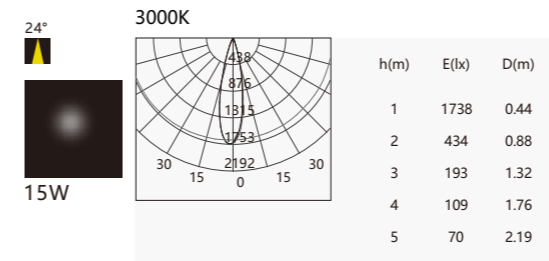
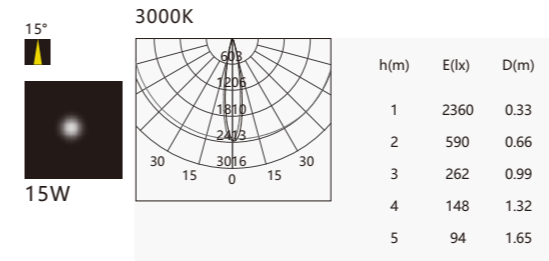
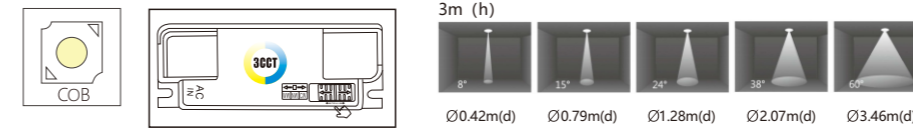

85-265V 50-60Hz	UGR≤6	LED	50000H Long Life
IP20	3000K Ra>80	4000K Ra>80	6500K Ra>80
OSRAM	SAN AN	CREE	BRIDGELUX
SHINE WH	UV BK	UV SL	WH BK

MODEL :
CD-2345-5W

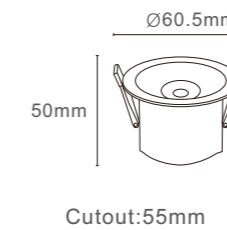

MODEL :
CD-2345-7W

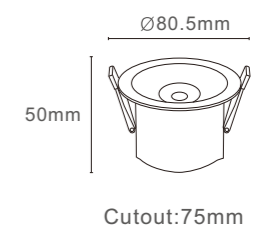

MODEL :
CD-2345-15W

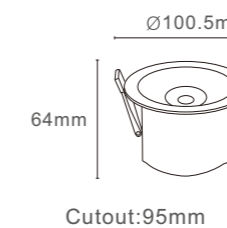



CD-2346

TECHNICAL SPECIFICATIONS

Product Name :	COB Downlight
Model no:	CD-2346
Power :	10W/15W/10W/15W/2*10W/2*15W
Input :	AC85-265V , 50 /60 HZ
Temperature range :	-20-50°C
Light source :	COB
Lumen :	80-110 LM/W
Colour Temperature :	3000K - 6500K/CCT
Colour Rendering Index :	CRI>80
Beam angle :	15°/24°/36°
Power factor :	Pf>0.5 / Pf>0.9
Power efficiency :	92%
Housing material :	Die-casting Aluminium
Optical material:	Reflective cup
Lighning protection :	1.5-4KV
Protection class :	Ip20



CD-2346 SERIES

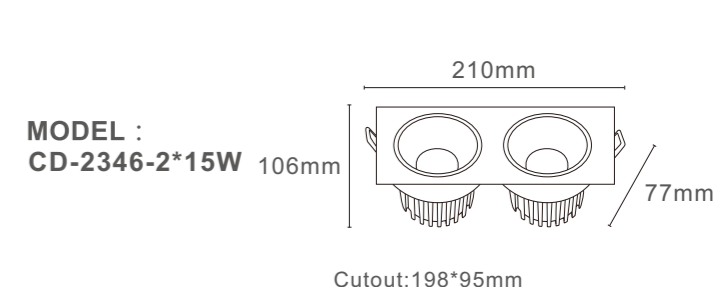
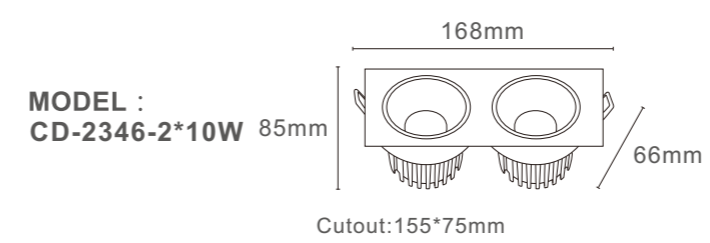
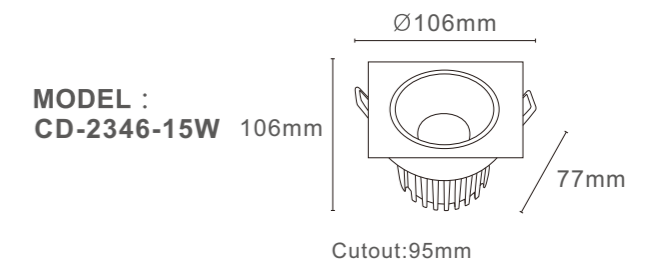
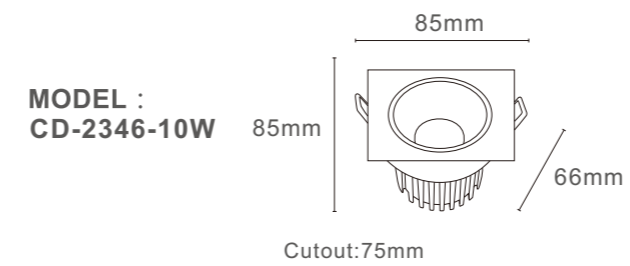
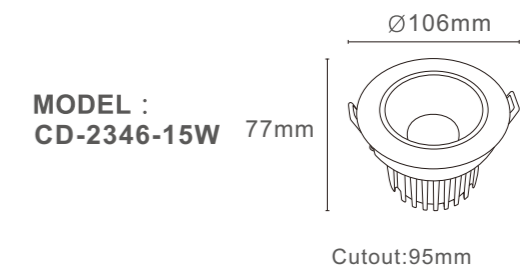
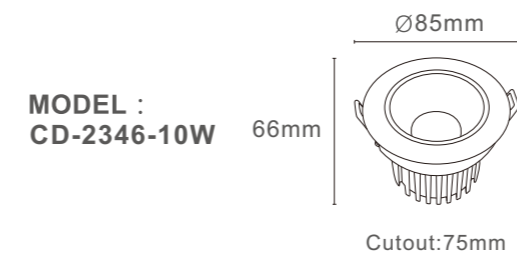
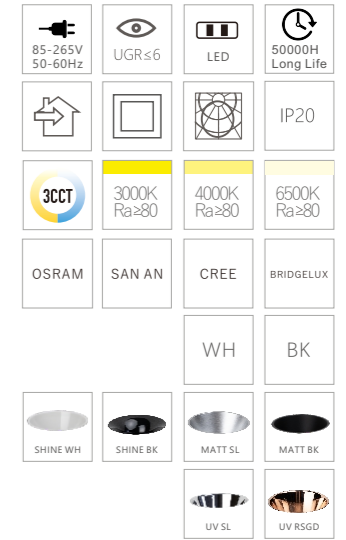
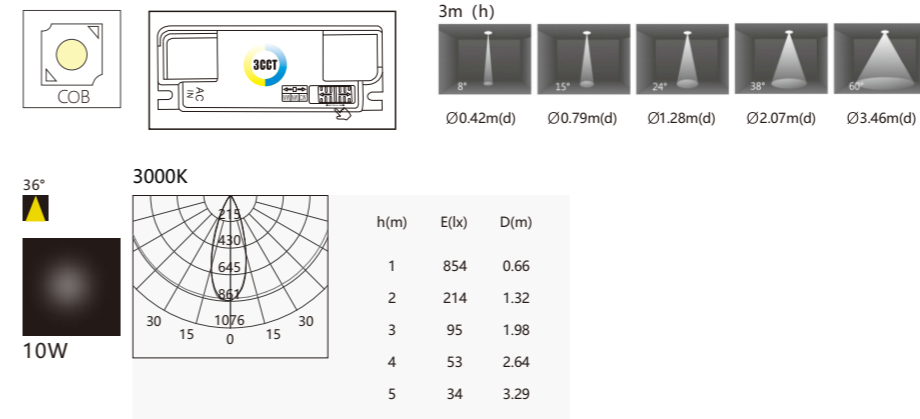



CD-2347

TECHNICAL SPECIFICATIONS

Product Name :	COB Downlight
Model no:	CD-2347
Power :	12W/24W/30W
Input :	AC85-265V , 50 /60 HZ
Temperature range :	-20-50°C
Light source :	COB
Lumen :	80-110 LM/W
Colour Temperature :	3000K - 6500K/CCT
Colour Rendering Index :	CRI>80
Beam angle :	105°
Power factor :	Pf>0.5 / Pf>0.9
Power efficiency :	92%
Housing material :	Die-casting Aluminium
Optical material:	Reflective cup+Lens/PS Diffuser
Lighning protection :	1.5-4KV
Protection class :	Ip20

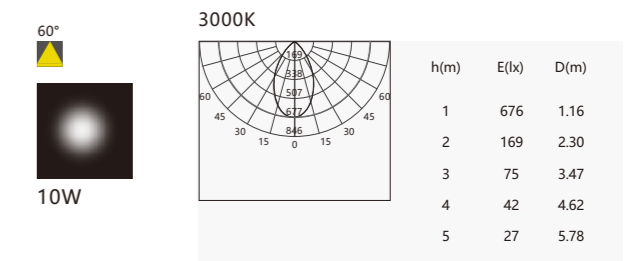
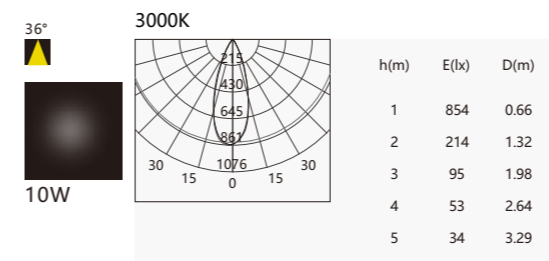
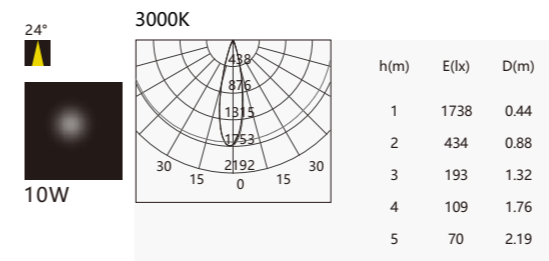
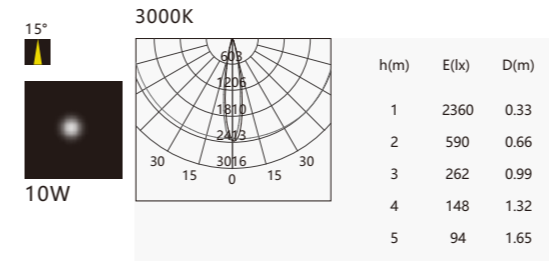
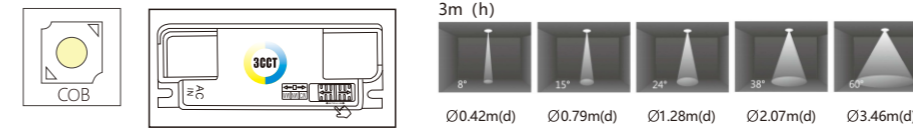

85-265V 50-60Hz	UGR≤6	LED	50000H Long Life
IP20	IP20	IP20	IP20
3000K Ra>80	4000K Ra>80	6500K Ra>80	
OSRAM	SAN AN	CREE	BRIDGELUX
	WH	BK	
	SHINE WH	SHINE BK	

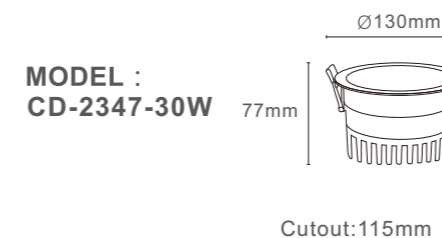
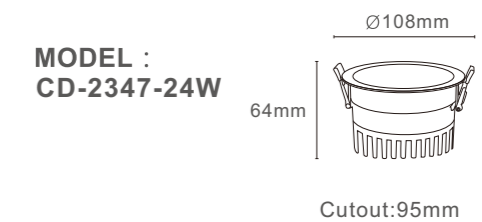
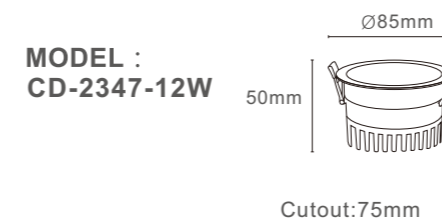



CD-2350

CD-2351

TECHNICAL SPECIFICATIONS

Product Name :	COB Downlight
Model no:	CD-2350/CD-2351
Power :	12W/10W
Input :	AC85-265V , 50 /60 HZ
Temperature range :	-20-50°C
Light source :	COB
Lumen :	80-110 LM/W
Colour Temperture :	3000K - 6500K/CCT
Colour Rendering Index :	CRI>80
Beam angle :	15°/24°/38°
Power factor :	Pf>0.5 / Pf>0.9
Power efficiency :	92%
Housing material :	Die-casting Aluminium
Optical material:	Reflective cup+Lens
Lighning protection :	1.5-4KV
Protection class :	Ip20



CD-2350/CD-2351 SERIES

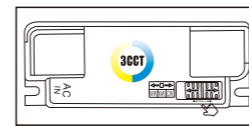
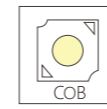

3m (h)

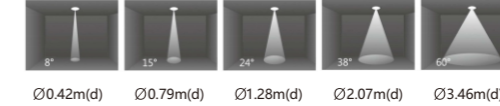

Ø0.42m(d) Ø0.79m(d) Ø1.28m(d) Ø2.07m(d) Ø3.46m(d)

15°

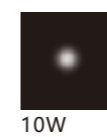

10W

3000K

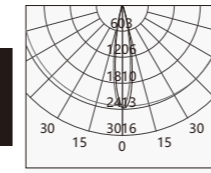

h(m)	E(lx)	D(m)
1	2360	0.33
2	590	0.66
3	262	0.99
4	148	1.32
5	94	1.65

24°

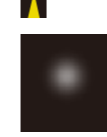

10W

3000K

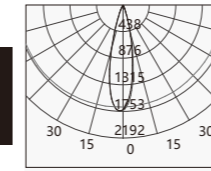

h(m)	E(lx)	D(m)
1	1738	0.44
2	434	0.88
3	193	1.32
4	109	1.76
5	70	2.19

38°



10W

3000K

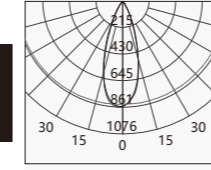

h(m)	E(lx)	D(m)
1	854	0.66
2	214	1.32
3	95	1.98
4	53	2.64
5	34	3.29

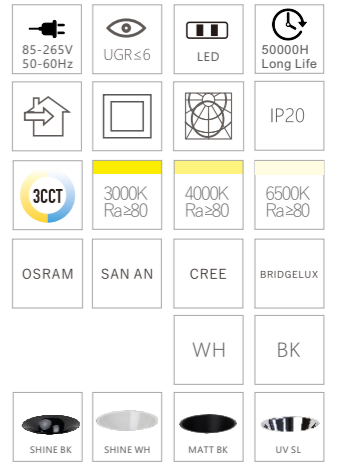

MODEL :
CD-2350-12W

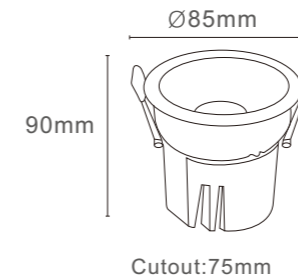

MODEL :
CD-2351-10W

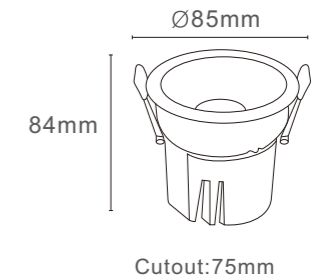

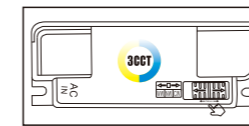
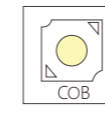

3m (h)

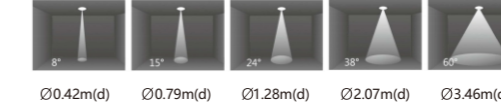

15°

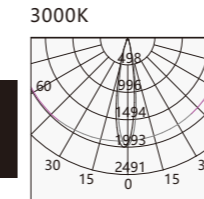
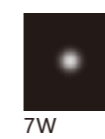

h(m)	E(lx)	D(m)
1	1968	0.33
2	492	0.66
3	219	0.99
4	123	1.32
5	79	1.65

24°

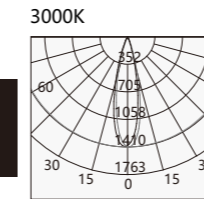
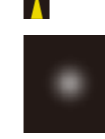

h(m)	E(lx)	D(m)
1	1409	0.43
2	352	0.86
3	157	1.29
4	88	1.72
5	56	2.15

36°

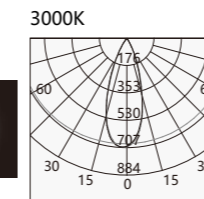

h(m)	E(lx)	D(m)
1	2577	0.92
2	644	1.84
3	286	2.76
4	161	3.69
5	103	4.61

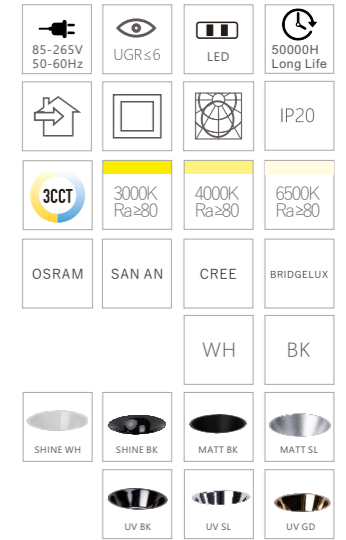

CD-2352

TECHNICAL SPECIFICATIONS

Product Name :	COB Downlight
Model no:	CD-2352
Power :	7W
Input :	AC85-265V , 50 /60 HZ
Temperature range :	-20-50°C
Light source :	COB
Lumen :	80-110 LM/W
Colour Temperture :	3000K - 6500K/CCT
Colour Rendering Index :	CRI>80
Beam angle :	15°/24°/36°
Power factor :	Pf>0.5 / Pf>0.9
Power efficiency :	92%
Housing material :	Die-casting Aluminium
Optical material:	Reflective cup/Lens
Lighning protection :	1.5-4KV
Protection class :	Ip20



MODEL :
CD-2352-7W



Cutout:75mm



CD-2354

TECHNICAL SPECIFICATIONS

Product Name :	COB Downlight
Model no:	CD-2354
Power :	7W/10W/7W/12W/18W/18W/30W
Input :	AC85-265V , 50 /60 HZ
Temperature range :	-20-50°C
Light source :	COB
Lumen :	80-110 LM/W
Colour Temperture :	3000K - 6500K/CCT
Colour Rendering Index :	CRI>80
Beam angle :	8°/15°/24°/38°/55°
Power factor :	Pf>0.5 / Pf>0.9
Power efficiency :	92%
Housing material :	Die-casting Aluminium
Optical material:	Reflective cup/Lens
Lighning protection :	1.5-4KV
Protection class :	Ip20



CD-2354 SERIES

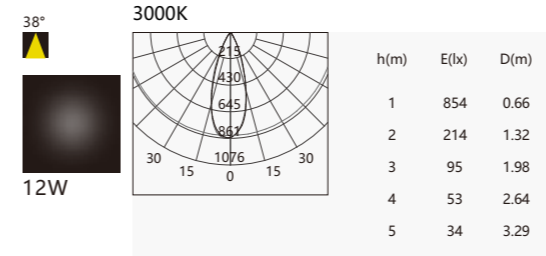
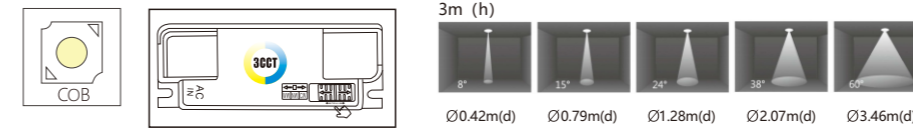

85-265V 50-60Hz	UGR≤6	LED	50000H Long Life
IP20	3000K Ra>80	4000K Ra>80	6500K Ra>80
OSRAM	SAN AN	CREE	BRIDGELUX
	WH	BK	
SHINE WH	SHINE BK	MATT WH	MATT BK
UV BK	UV SL	UV GD	UV RSGD

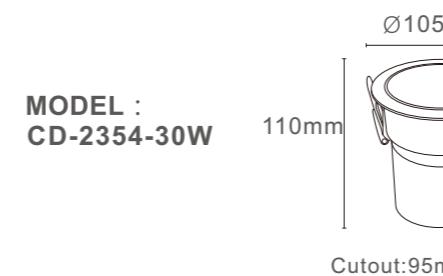
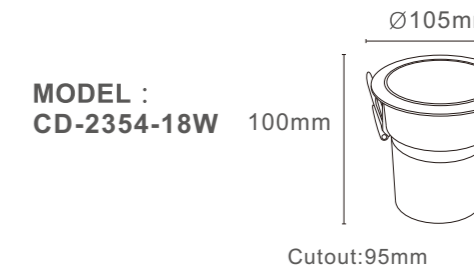
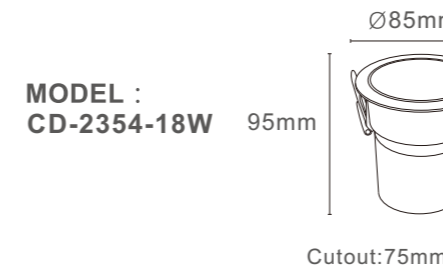
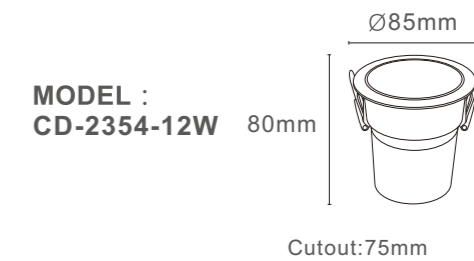
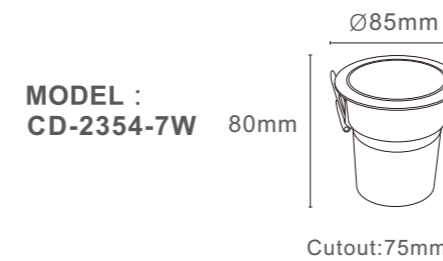
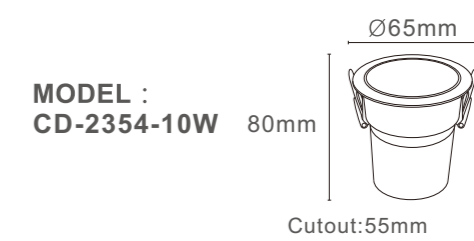
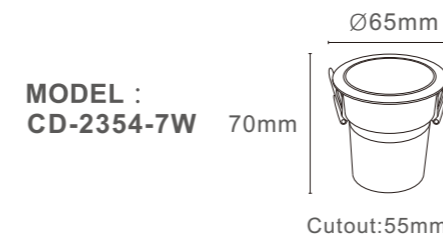



CD-2356

TECHNICAL SPECIFICATIONS

Product Name :	COB Downlight
Model no:	CD-2356
Power :	7W/12W/24W
Input :	AC85-265V , 50 /60 HZ
Temperature range :	-20-50°C
Light source :	COB
Lumen :	80-110 LM/W
Colour Temperture :	3000K - 6500K/CCT
Colour Rendering Index :	CRI>80
Beam angle :	15°/24°/38°
Power factor :	Pf>0.5 / Pf>0.9
Power efficiency :	92%
Housing material :	Die-casting Aluminium
Optical material:	Reflective cup
Lighning protection :	1.5-4KV
Protection class :	Ip20

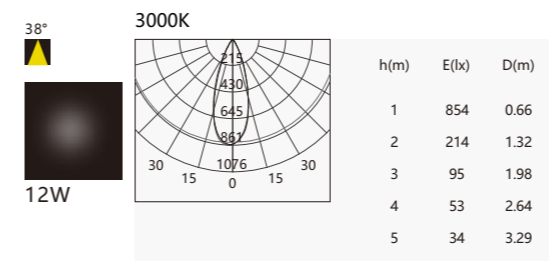
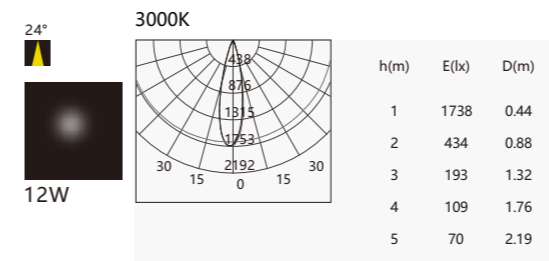
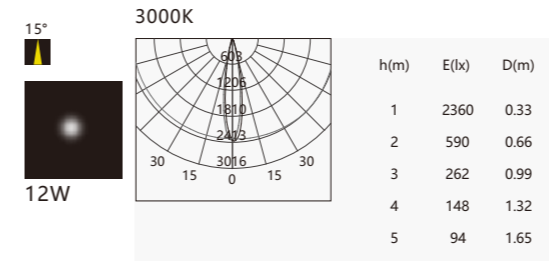
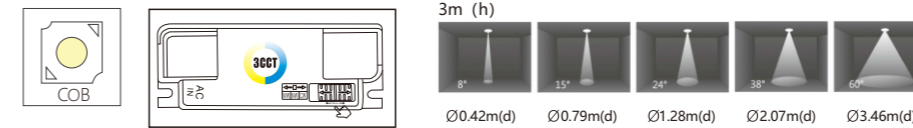

85-265V 50-60HZ	UGR≤6	LED	50000H Long Life
IP20	IP20	IP20	IP20
3CCT	3000K Ra>80	4000K Ra>80	6500K Ra>80
OSRAM	SAN AN	CREE	BRIDGELUX
	WH	BK	
	MATT WH	MATT BK	

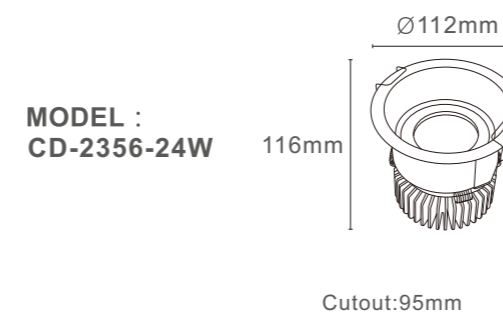
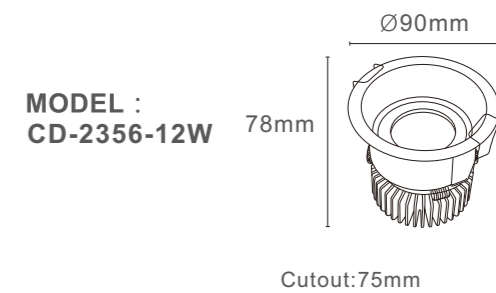
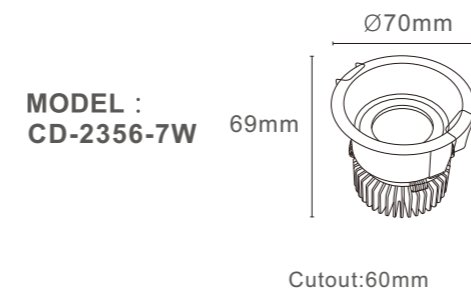



CD-2357

TECHNICAL SPECIFICATIONS

Product Name :	COB Downlight
Model no:	CD-2357
Power :	12W
Input :	AC85-265V , 50 /60 HZ
Temperature range :	-20-50°C
Light source :	COB
Lumen :	80-110 LM/W
Colour Temperture :	3000K - 6500K/CCT
Colour Rendering Index :	CRI>80
Beam angle :	15°/24°/38°
Power factor :	Pf>0.5 / Pf>0.9
Power efficiency :	92%
Housing material :	Die-casting Aluminium
Optical material:	Reflective cup
Lighning protection :	1.5-4KV
Protection class :	Ip20



CD-2357 SERIES

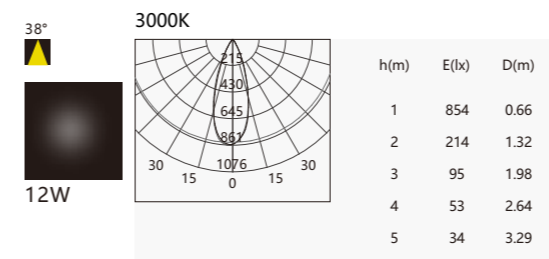
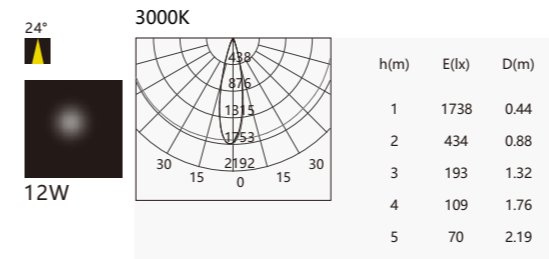
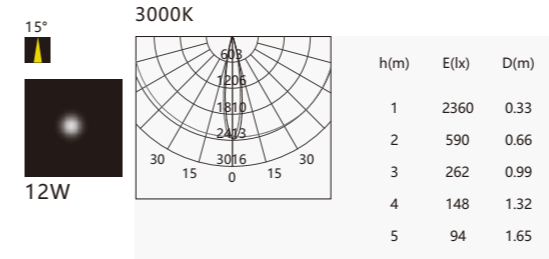
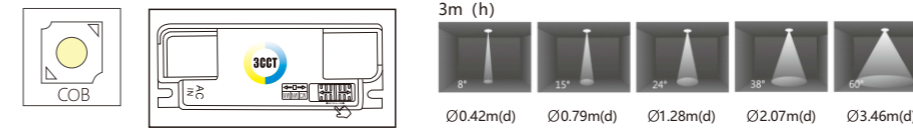

85-265V 50-60Hz	UGR≤6	LED	50000H Long Life
IP20	IP20	IP20	IP20
3000K Ra>80	4000K Ra>80	6500K Ra>80	
OSRAM	SAN AN	CREE	BRIDGELUX
	WH	BK	
	SHINE WH	SHINE BK	
UV BK	UV SL	UV GD	UV RSGD

MODEL :
CD-2357-12W

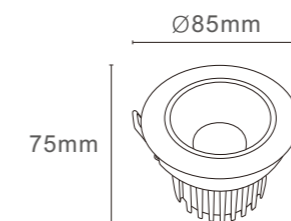

Cutout:75mm

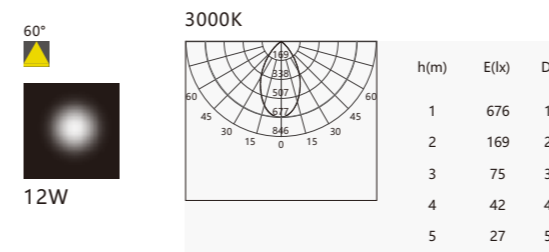
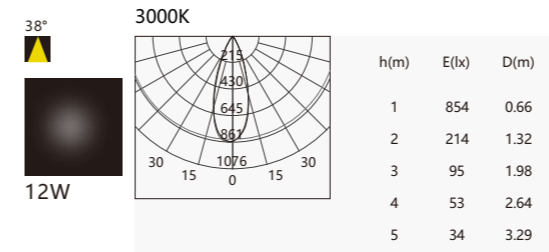
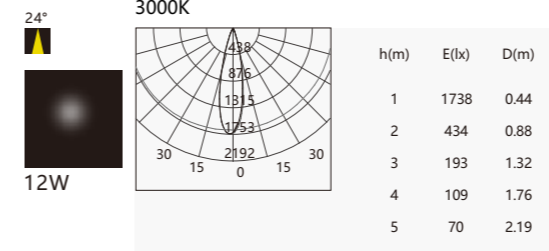
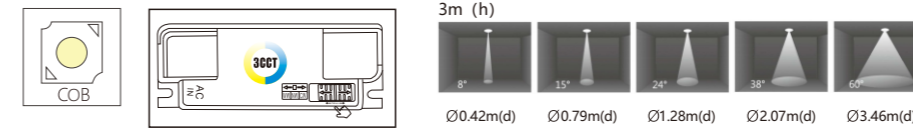

85-265V 50-60HZ	UGR≤6	LED	50000H Long Life
IP20	IP20	IP20	IP20
3CCT	3000K Ra>80	4000K Ra>80	6500K Ra>80
OSRAM	SAN AN	CREE	BRIDGELUX
	WH	BK	
	SAND WH	SAND BK	
UV BK	UV SL	UV GD	UV RSGD

CD-2358

TECHNICAL SPECIFICATIONS

Product Name :	COB Downlight
Model no:	CD-2358
Power :	7W/12W18W
Input :	AC85-265V , 50 /60 HZ
Temperature range :	-20-50°C
Light source :	COB
Lumen :	80-110 LM/W
Colour Temperture :	3000K - 6500K/CCT
Colour Rendering Index :	CRI>80
Beam angle :	24°/38°/60°
Power factor :	Pf>0.5 / Pf>0.9
Power efficiency :	92%
Housing material :	Die-casting Aluminium
Optical material:	Reflective cup
Lighning protection :	1.5-4KV
Protection class :	Ip20

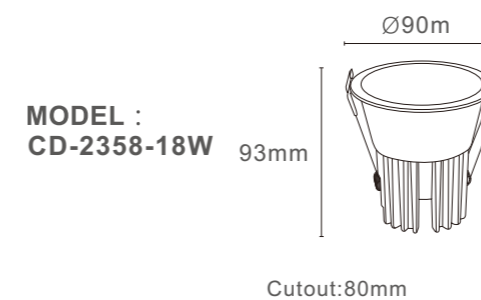
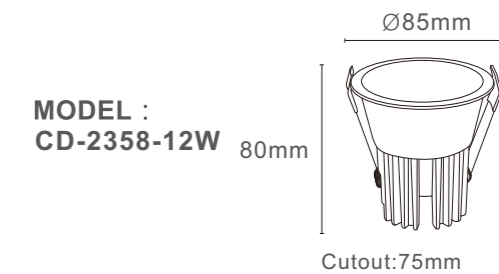
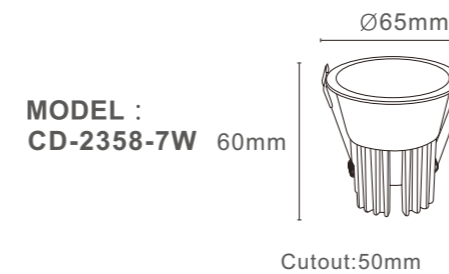



CD-2359

TECHNICAL SPECIFICATIONS

Product Name :	COB Downlight
Model no:	CD-2359
Power :	7W/10W/7W/12W/18W/18W/30W
Input :	AC85-265V , 50 /60 HZ
Temperature range :	-20-50°C
Light source :	COB
Lumen :	80-110 LM/W
Colour Temperture :	3000K - 6500K/CCT
Colour Rendering Index :	CRI>80
Beam angle :	8°/15°/24°/38°/55°
Power factor :	Pf>0.5 / Pf>0.9
Power efficiency :	92%
Housing material :	Die-casting Aluminium
Optical material:	Reflective cup+Lens
Lighning protection :	1.5-4KV
Protection class :	Ip20



CD-2359 SERIES

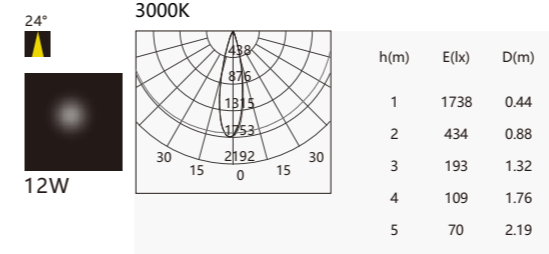
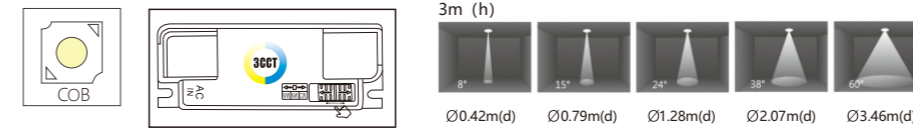

85-265V 50-60Hz	UGR≤6	LED	50000H Long Life
IP20	IP20	IP20	IP20
3000K Ra>80	4000K Ra>80	6500K Ra>80	
OSRAM	SAN AN	CREE	BRIDGELUX
	WH	BK	
SHINE WH	SHINE BK	MATT BK	MATT SL
UV BK	UV SL	UV GD	UV RSGD

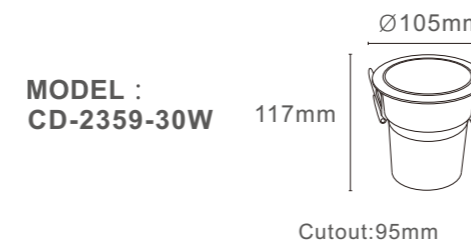
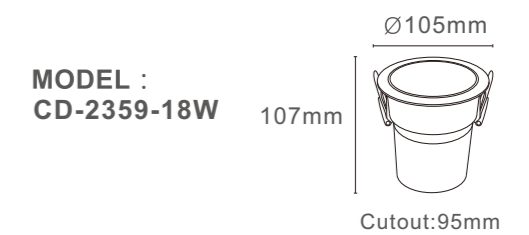
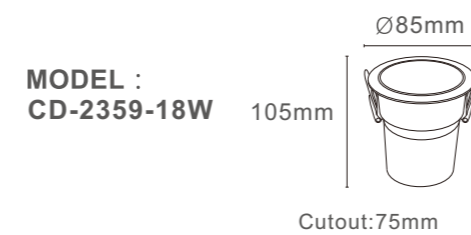
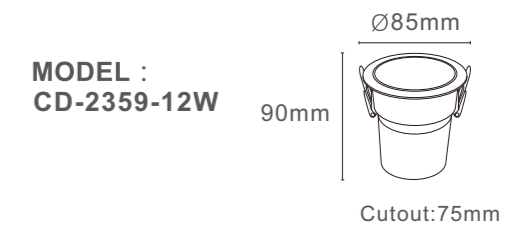
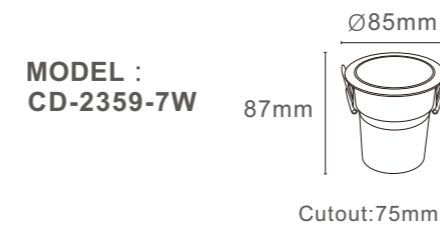
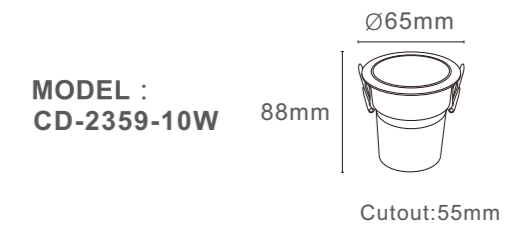
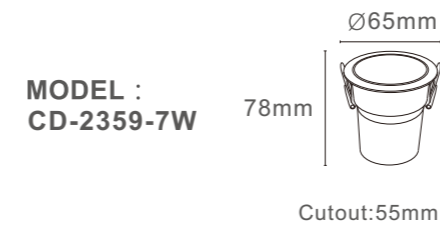

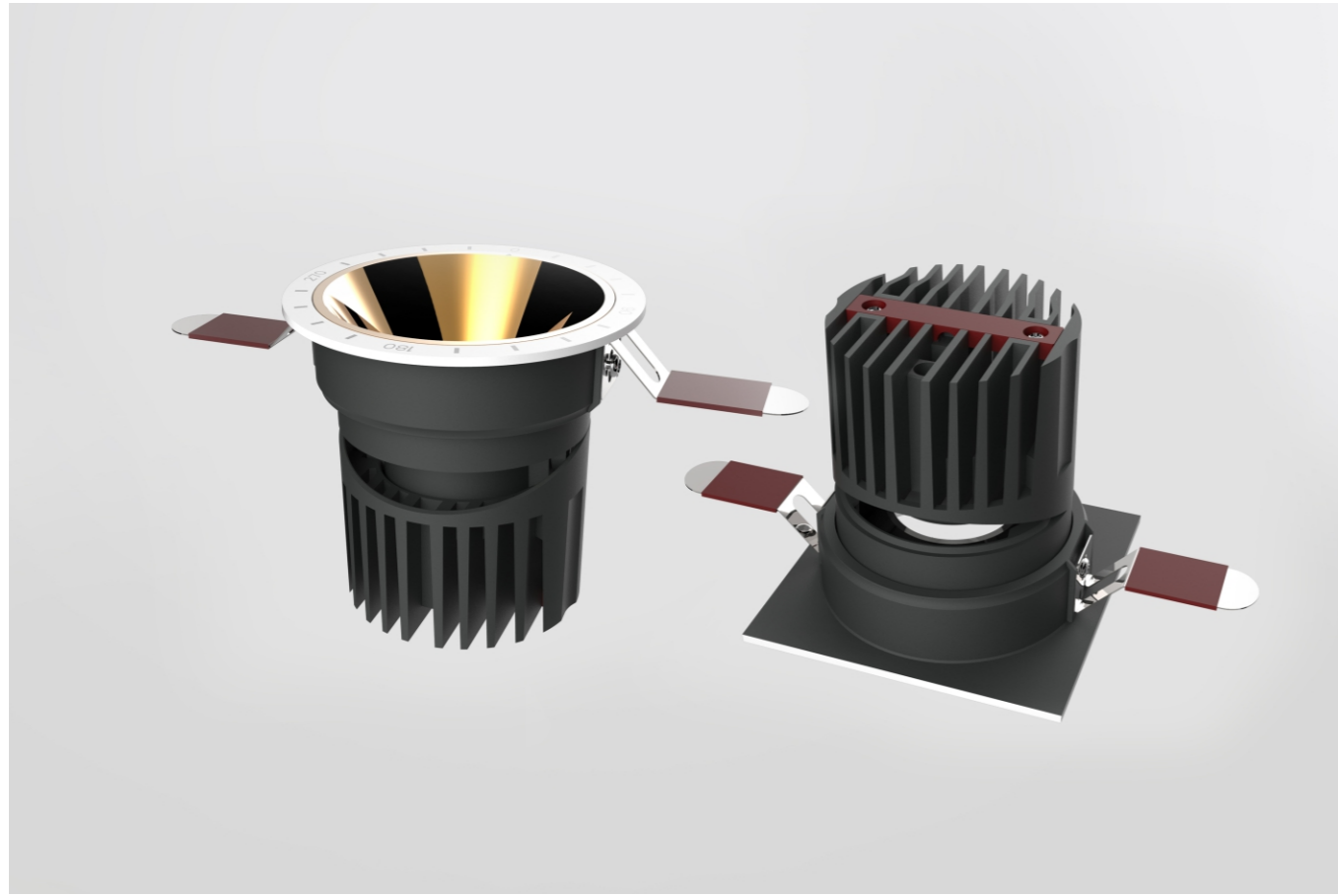

CD-2360

TECHNICAL SPECIFICATIONS

Product Name :	COB Downlight
Model no:	CD-2360
Power :	7W/12W
Input :	AC85-265V , 50 /60 HZ
Temperature range :	-20-50°C
Light source :	COB
Lumen :	80-110 LM/W
Colour Temperture :	3000K - 6500K/CCT
Colour Rendering Index :	CRI>80
Beam angle :	15°/24°/36°/54°
Power factor :	Pf>0.5 / Pf>0.9
Power efficiency :	92%
Housing material :	Die-casting Aluminium
Optical material:	Reflective cup+Lens
Lighning protection :	1.5-4KV
Protection class :	Ip20

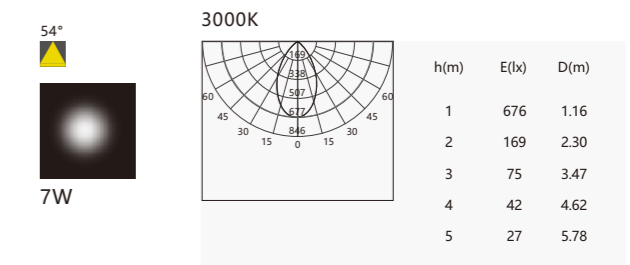
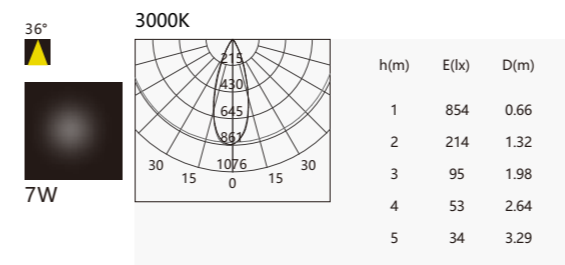
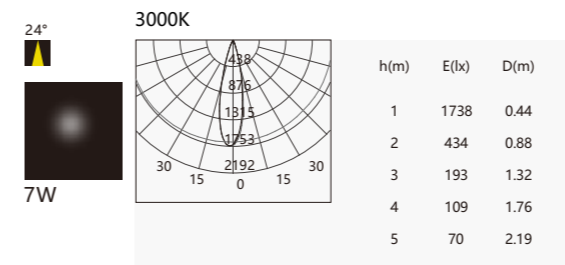
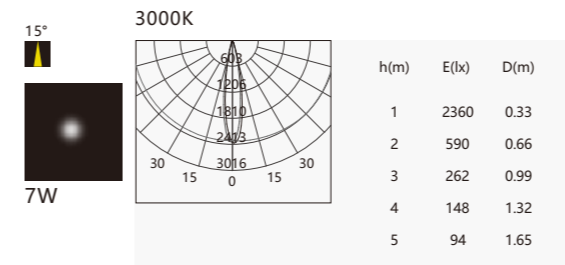
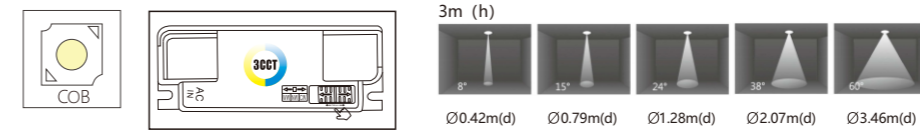

85-265V 50-60Hz	UGR≤6	LED	50000H Long Life
IP20	IP20	IP20	IP20
3000K Ra>80	4000K Ra>80	6500K Ra>80	
OSRAM	SAN AN	CREE	BRIDGELUX
	WH	BK	
SHINE WH	MATT BK	MATT SL	
UV BK	UV SL	UV RSGD	

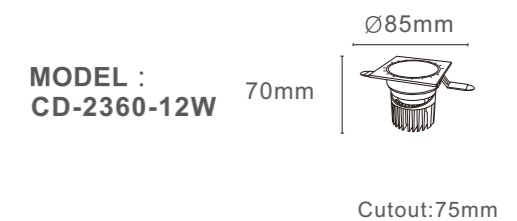
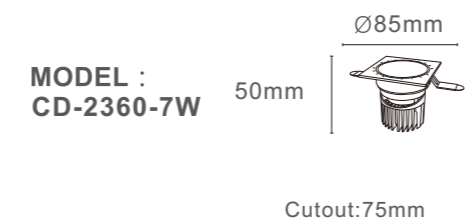



CD-2361

TECHNICAL SPECIFICATIONS

Product Name :	COB Downlight
Model no:	CD-2361
Power :	7W/7W/2*7W/3*7W
Input :	AC85-265V , 50 /60 HZ
Temperature range :	-20-50°C
Light source :	COB
Lumen :	80-100 LM/W
Colour Temperture :	3000K - 6500K
Colour Rendering Index :	CRI>80
Beam angle :	15°/24°/36°/50°
Power factor :	Pf>0.5 / Pf>0.9
Power efficiency :	92%
Housing material :	Die-casting Aluminium
Optical material:	Reflective cup+Lens
Lighning protection :	1.5-4KV
Protection class :	Ip20

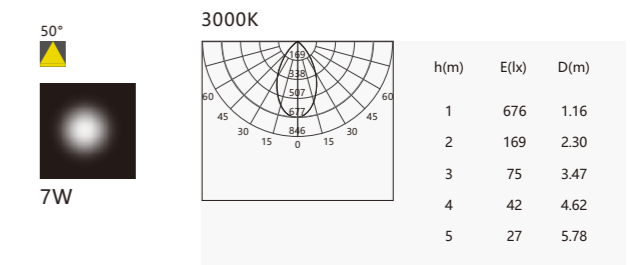
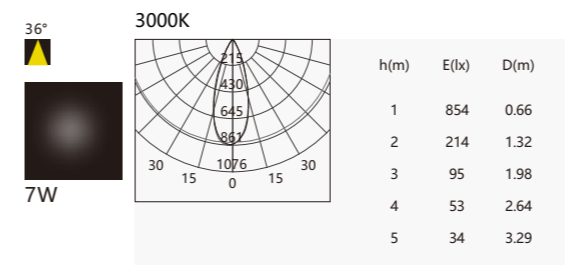
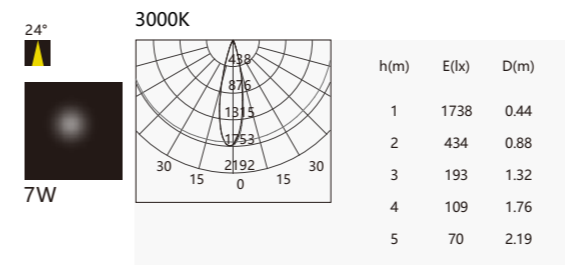
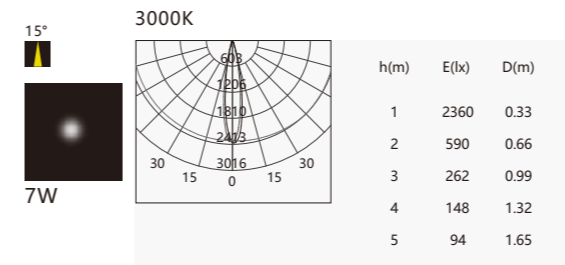
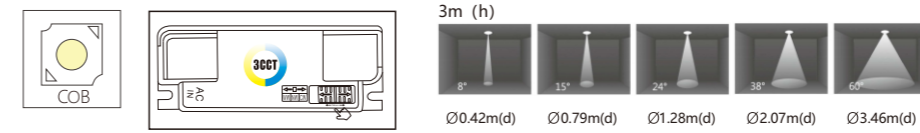

- 85-265V 50-60Hz
- UGR≤6
- LED
- 50000H Long Life
- IP20
- 3 CCT
- 3000K Ra>80
- 4000K Ra>80
- 6500K Ra>80
- OSRAM
- SAN AN
- CREE
- BRIDGELUX
- WH
- BK
- MATT WH
- MATT BK

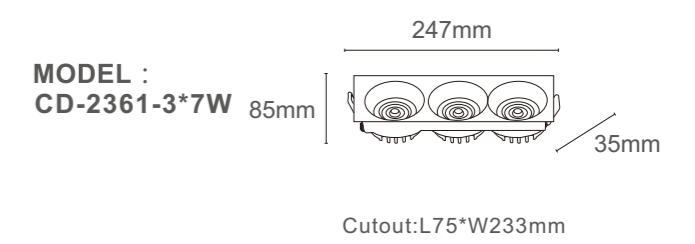
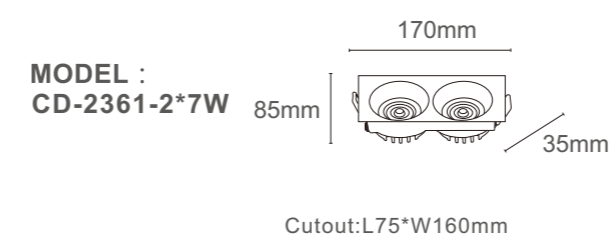
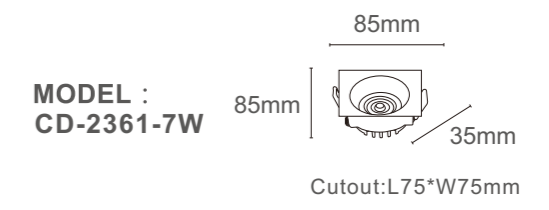
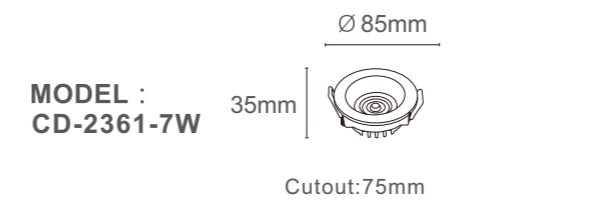



CD-2362

CD-2363

TECHNICAL SPECIFICATIONS

Product Name :	COB Downlight
Model no:	CD-2362/CD-2363
Power :	5W/10W/5W/10W
Input :	AC85-265V , 50 /60 HZ
Temperature range :	-20-50°C
Light source :	COB
Lumen :	80-110 LM/W
Colour Temperture :	3000K - 6500K/CCT
Colour Rendering Index :	CRI>80
Beam angle :	15°/24°/36°
Power factor :	Pf>0.5 / Pf>0.9
Power efficiency :	92%
Housing material :	Die-casting Aluminium
Optical material:	Reflective cup
Lighning protection :	1.5-4KV
Protection class :	Ip20



CD-2362/CD2363 SERIES

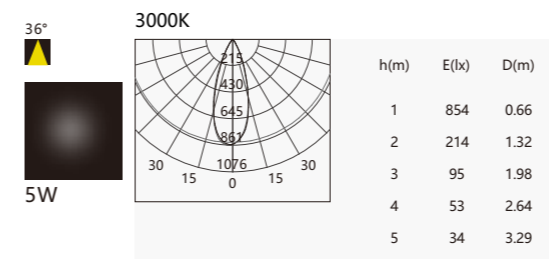
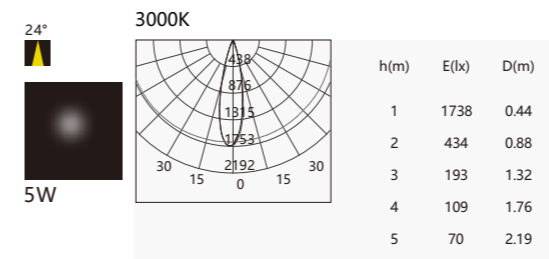
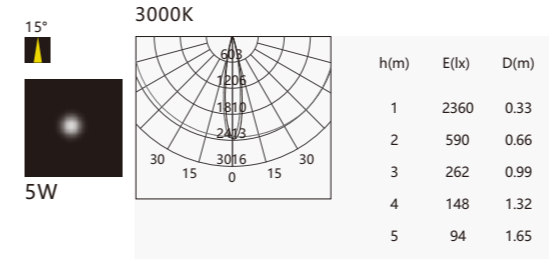
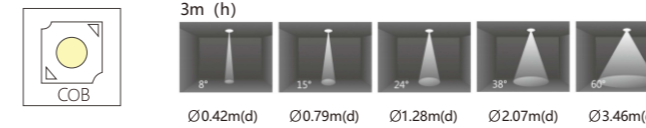

85-265V 50-60Hz	UGR≤6	LED	50000H Long Life
IP20	3000K Ra>80	4000K Ra>80	6500K Ra>80
OSRAM	SAN AN	CREE	BRIDGELUX
	WH	BK	

MODEL :
CD-2362-5W

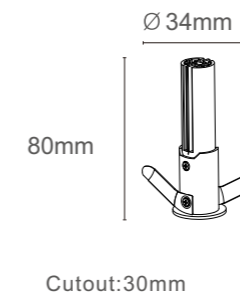

MODEL :
CD-2362-10W

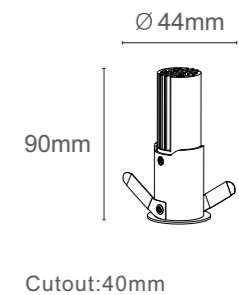

MODEL :
CD-2363-5W

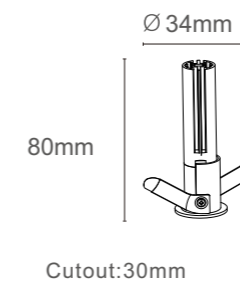

MODEL :
CD-2363-10W

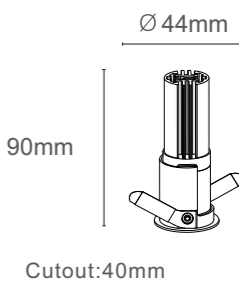



CD-2364 SERIES

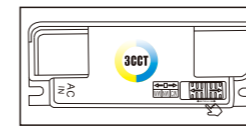
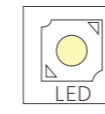

3m (h)

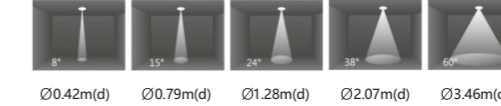

Ø0.42m(d) Ø0.79m(d) Ø1.28m(d) Ø2.07m(d) Ø3.46m(d)

105°

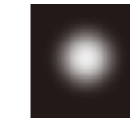

10W

3000K

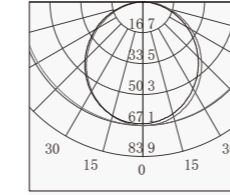

h(m)	E(lx)	D(m)
1	672	2.94
2	168	5.89
3	75	8.83
4	42	11.78
5	27	14.72

85-265V 50-60Hz	UGR≤6	LED	50000H Long Life
IP20	IP20	IP20	IP20
3 CCT	3000K Ra>80	4000K Ra>80	6500K Ra>80
OSRAM	SAN AN	CREE	BRIDGELUX
	WH	BK	

CD-2364

TECHNICAL SPECIFICATIONS

Product Name :	SMD Downlight
Model no:	CD-2364
Power :	5W/10W/12W
Input :	AC85-265V , 50 /60 HZ
Temperature range :	-20-50°C
Light source :	SMD
Lumen :	80-110 LM/W
Colour Temperture :	3000K - 6500K/CCT
Colour Rendering Index :	CRI>80
Beam angle :	105°
Power factor :	Pf>0.5 / Pf>0.9
Power efficiency :	92%
Housing material :	Die-casting Aluminium
Cover material :	PC & Aluminium
Lighning protection :	1.5-4KV
Protection class :	Ip20

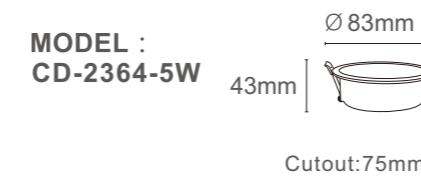



CD-2365

TECHNICAL SPECIFICATIONS

Product Name :	COB Downlight
Model no:	CD-2365
Power :	7W/12W
Input :	AC85-265V , 50 /60 HZ
Temperature range :	-20-50°C
Light source :	COB
Lumen :	80-110 LM/W
Colour Temperture :	3000K - 6500K/CCT
Colour Rendering Index :	CRI>80
Beam angle :	15°/24°/38°
Power factor :	Pf>0.5 / Pf>0.9
Power efficiency :	92%
Housing material :	Die-casting Aluminium
Optical material:	Lens
Lighning protection :	1.5-4KV
Protection class :	Ip20



CD-2365 SERIES

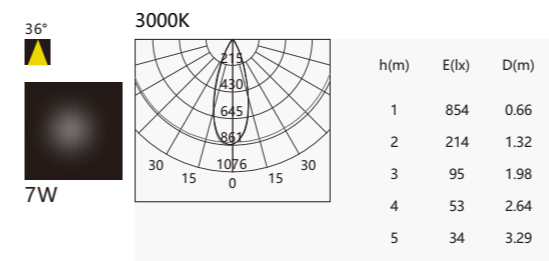
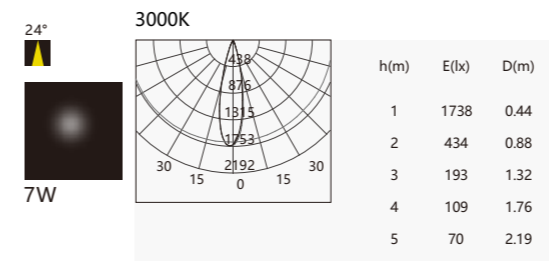
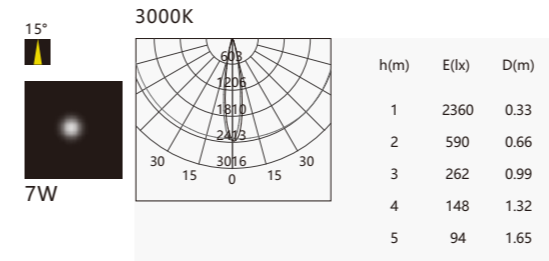
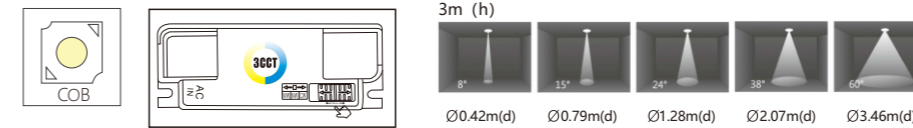

85-265V 50-60Hz	UGR≤6	LED	50000H Long Life
IP20	IP20	IP20	IP20
3CCT	3000K Ra>80	4000K Ra>80	6500K Ra>80
OSRAM	SAN AN	CREE	BRIDGELUX
	WH	BK	

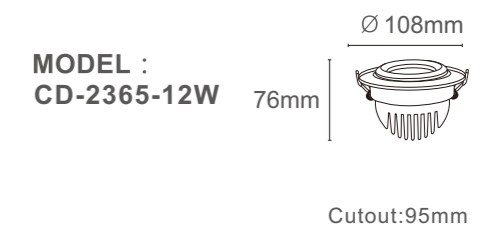
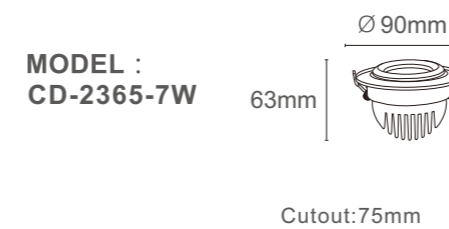



CD-2366

TECHNICAL SPECIFICATIONS

Product Name :	COB Downlight
Model no:	CD-2366
Power :	7W/12W/18W
Input :	AC85-265V , 50 /60 HZ
Temperature range :	-20-50°C
Light source :	COB
Lumen :	80-100 LM/W
Colour Temperture :	3000K - 6500K
Colour Rendering Index :	CRI>80
Beam angle :	10°/23°/36°
Power factor :	Pf>0.5 / Pf>0.9
Power efficiency :	92%
Housing material :	Die-casting Aluminium
Optical material:	Lens
Lighning protection :	1.5-4KV
Protection class :	Ip20



CD-2366 SERIES

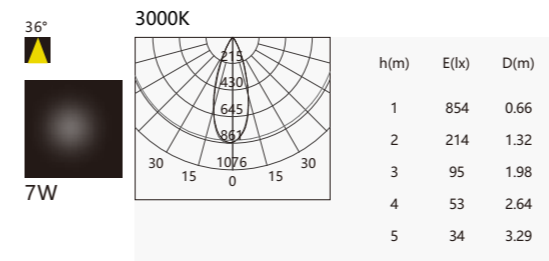
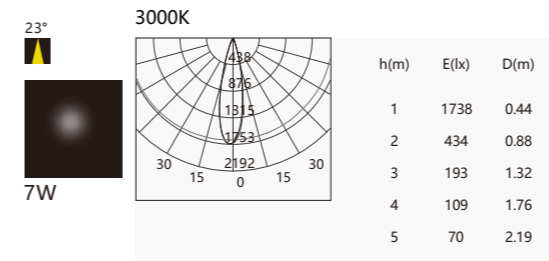
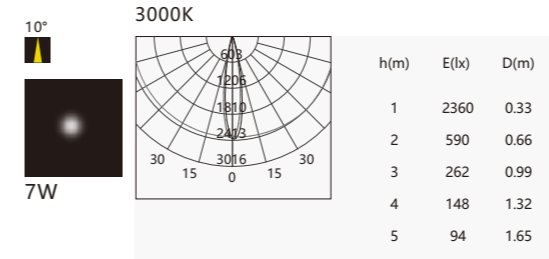
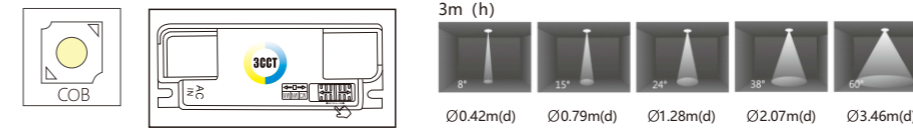

85-265V 50-60Hz	UGR≤6	LED	50000H Long Life
IP20	IP20	IP20	IP20
3000K Ra>80	4000K Ra>80	6500K Ra>80	
OSRAM	SAN AN	CREE	BRIDGELUX
	WH	BK	
	MATT WH	MATT BK	

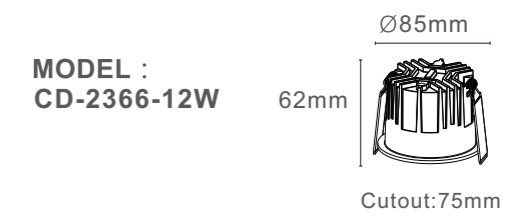
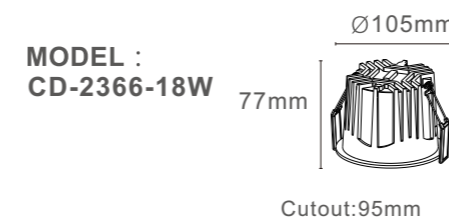
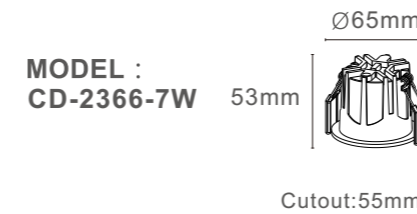



CD-2367

TECHNICAL SPECIFICATIONS

Product Name :	COB Downlight
Model no:	CD-2367
Power :	7W/2*7W/3*7W/4*7W/12W/2*12W/ 3*12W/4*12W/18W/18W
Input :	AC85-265V , 50 /60 HZ
Temperature range :	-20-50°C
Light source :	COB
Lumen :	80-110 LM/W
Colour Temperature :	3000K - 6500K/CCT
Colour Rendering Index :	CRI>80
Beam angle :	10°/23°/36°
Power factor :	Pf>0.5 / Pf>0.9
Power efficiency :	92%
Housing material :	Die-casting Aluminium
Optical material:	Reflective cup+Lens
Lighning protection :	1.5-4KV
Protection class :	Ip20



CD-2367 SERIES

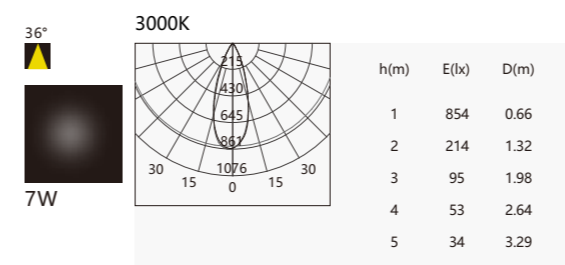
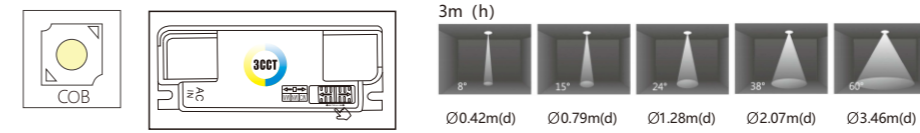

85-265V 50-60HZ	UGR≤6	LED	50000H Long Life
IP20	3000K Ra>80	4000K Ra>80	6500K Ra>80
OSRAM	SAN AN	CREE	BRIDGELUX
WH	BK	MATTWH	MATTKB

MODEL : CD-2367-7W Cutout:L55*W55mm	MODEL : CD-2367-2*7W Cutout:L115*W55mm
MODEL : CD-2367-3*7W Cutout:L175*W55mm	MODEL : CD-2367-4*7W Cutout:L115*W115mm
MODEL : CD-2367-12W Cutout:L75*L75mm	MODEL : CD-2367-2*12W Cutout:L160*W75mm
MODEL : CD-2367-3*12W Cutout:L240*W75mm	MODEL : CD-2367-4*12W Cutout:L155*W155mm
MODEL : CD-2367-18W Cutout:L95*W95mm	MODEL : CD-2367-18W Cutout:L195*W95mm



CD-2368

TECHNICAL SPECIFICATIONS

Product Name :	COB Downlight
Model no:	CD-2368
Power :	12W
Input :	AC85-265V , 50 /60 HZ
Temperature range :	-20-50°C
Light source :	COB
Lumen :	80-110 LM/W
Colour Temperture :	3000K - 6500K/CCT
Colour Rendering Index :	CRI>80
Beam angle :	10°/23°/36°
Power factor :	Pf>0.5 / Pf>0.9
Power efficiency :	92%
Housing material :	Die-casting Aluminium
Optical material:	Reflective cup+Lens
Lighning protection :	1.5-4KV
Protection class :	Ip20



CD-2368 SERIES

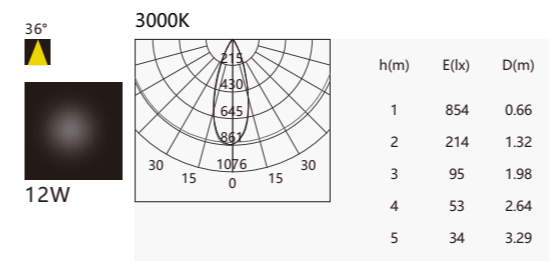
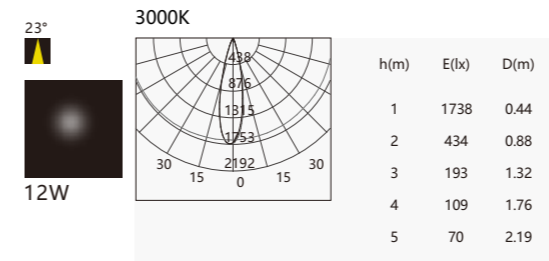
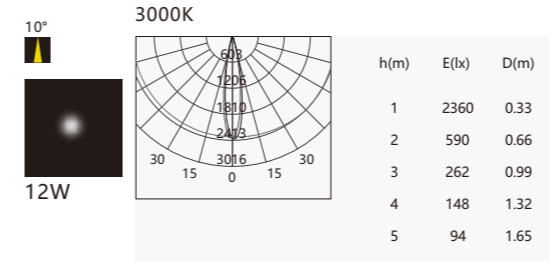
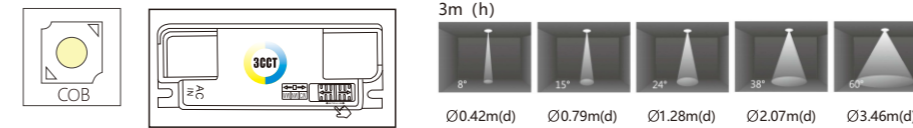

85-265V 50-60Hz	UGR≤6	LED	50000H Long Life
IP20	IP20	IP20	IP20
3000K Ra>80	4000K Ra>80	6500K Ra>80	
OSRAM	SAN AN	CREE	BRIDGELUX
	WH	BK	
	MATT WH	MATT BK	

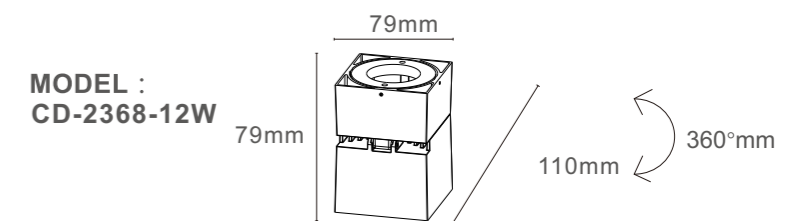
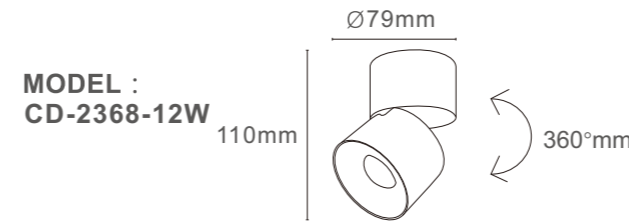



CD-2369

TECHNICAL SPECIFICATIONS

Product Name :	COB Downlight
Model no:	CD-2369
Power :	15W
Input :	AC85-265V , 50 /60 HZ
Temperature range :	-20-50°C
Light source :	COB
Lumen :	80-110 LM/W
Colour Temperture :	3000K - 6500K/CCT
Colour Rendering Index :	CRI>80
Beam angle :	10°/23°/36°
Power factor :	Pf>0.5 / Pf>0.9
Power efficiency :	92%
Housing material :	Die-casting Aluminium
Optical material:	Reflective cup
Lighning protection :	1.5-4KV
Protection class :	Ip20



CD-2368 SERIES

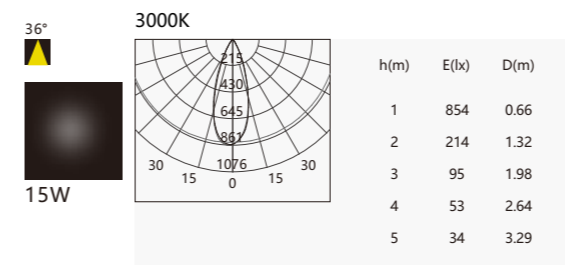
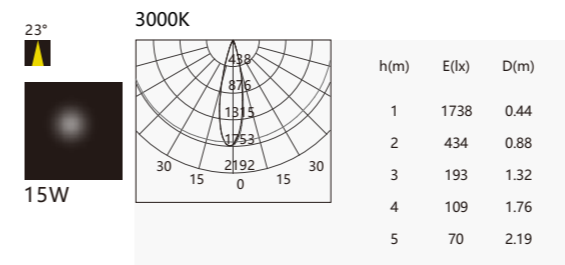
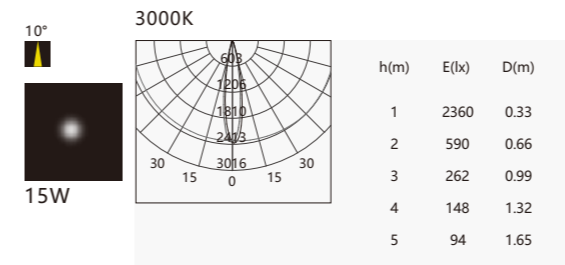
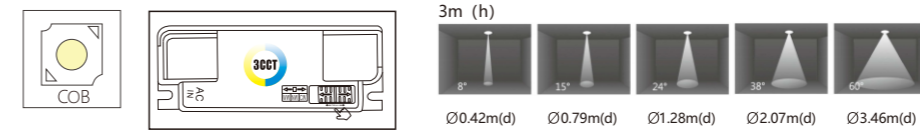

85-265V 50-60Hz	UGR≤6	LED	50000H Long Life
IP20	IP20	IP20	IP20
3CCT	3000K Ra>80	4000K Ra>80	6500K Ra>80
OSRAM	SAN AN	CREE	BRIDGELUX
	WH	BK	

**MODEL :
CD-2369-15W**

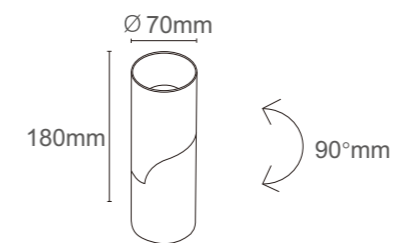



CD-2390

TECHNICAL SPECIFICATIONS

Product Name :	COB Downlight
Model no:	CD-2390
Power :	18W/30W
Input :	AC85-265V , 50 /60 HZ
Temperature range :	-20-50°C
Light source :	COB
Lumen :	80-110 LM/W
Colour Temperture :	3000K - 6500K/CCT
Colour Rendering Index :	CRI>80
Beam angle :	12°/24°/38°/60°
Power factor :	Pf>0.5 / Pf>0.9
Power efficiency :	92%
Housing material :	Die-casting Aluminium
Optical material:	Lens
Lighning protection :	1.5-4KV
Protection class :	Ip20



CD-2390 SERIES

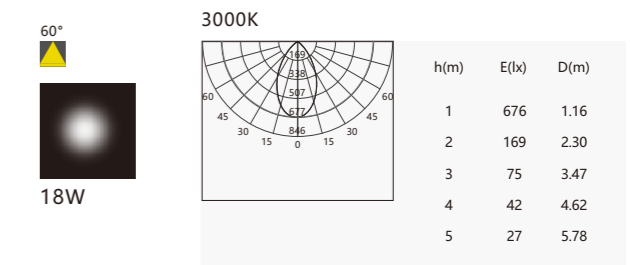
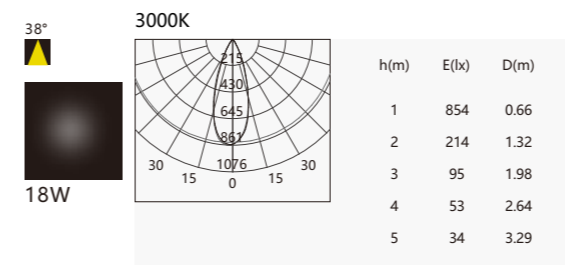
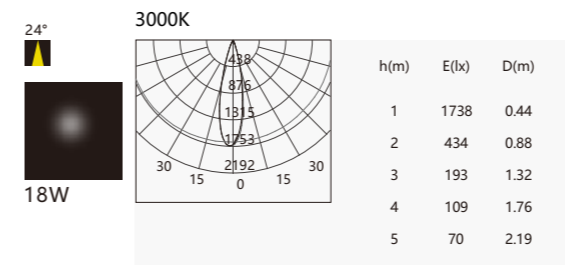
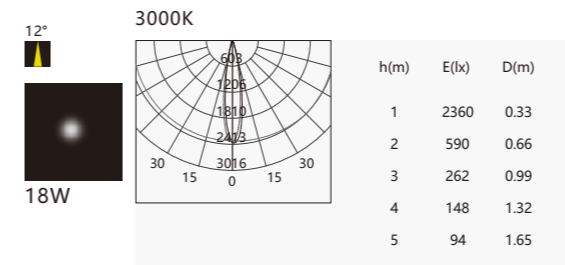
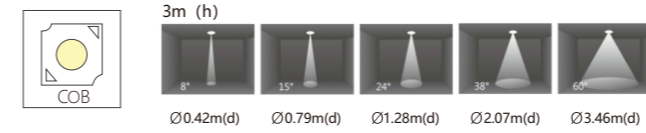

85-265V 50-60Hz	UGR≤6	LED	50000H Long Life
IP20	3000K Ra>80	4000K Ra>80	6500K Ra>80
OSRAM	SAN AN	CREE	BRIDGELUX
WH	BK	MATT WH	MATT BK

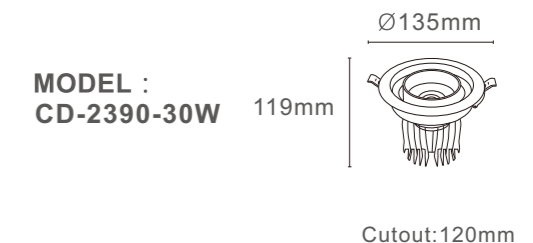
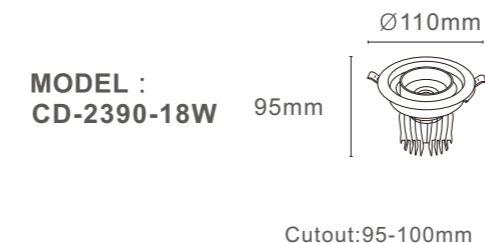

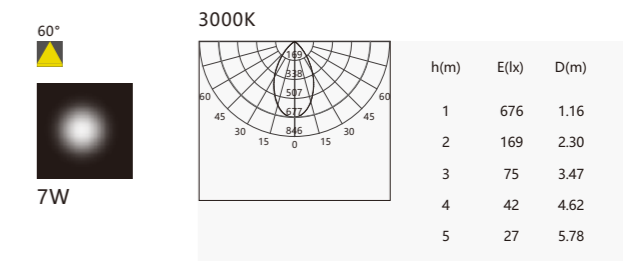
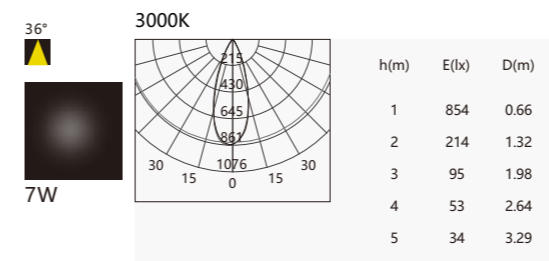
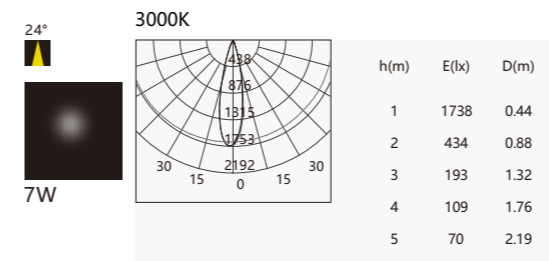
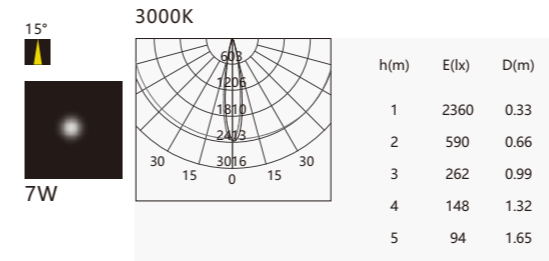
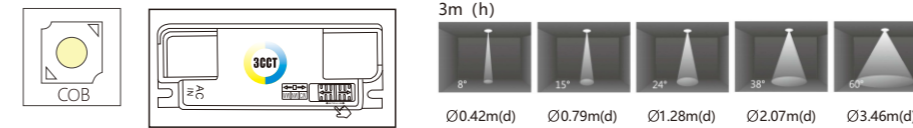

KZ02

TECHNICAL SPECIFICATIONS

Product Name :	COB Downlight
Model no:	KZ02
Power :	7W/12W/15W/18W
Input :	AC85-265V , 50 /60 HZ
Temperature range :	-20-50°C
Light source :	COB
Lumen :	80-110 LM/W
Colour Temperture :	3000K - 6500K/CCT
Colour Rendering Index :	CRI>80
Beam angle :	15°/24°/36°/60°
Power factor :	Pf>0.5 / Pf>0.9
Power efficiency :	92%
Housing material :	Die-casting Aluminium
Optical material:	Reflective cup+Lens
Lighning protection :	1.5-4KV
Protection class :	Ip20

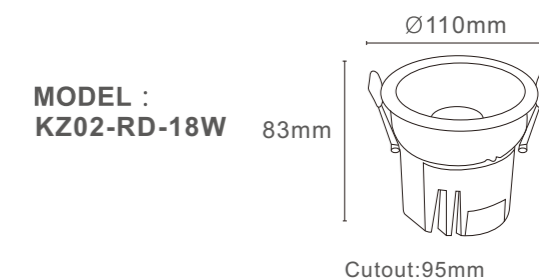
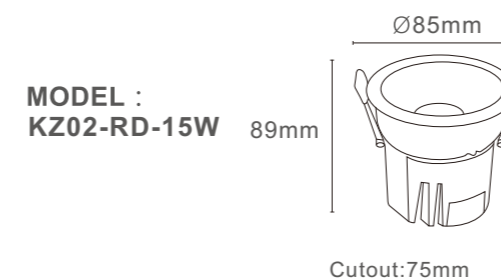
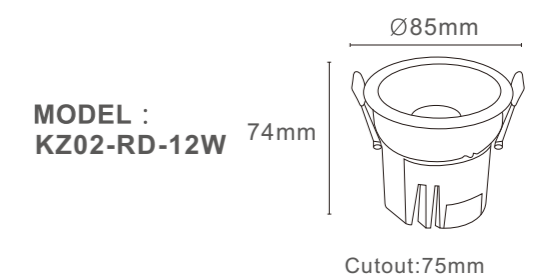
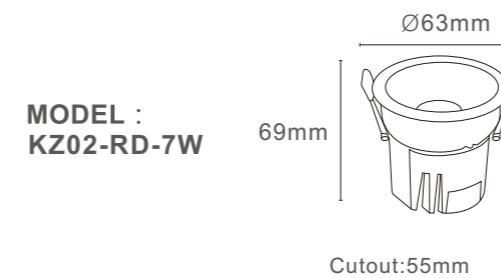



KZ03-RD

TECHNICAL SPECIFICATIONS

Product Name :	COB Downlight
Model no:	KZ03-RD
Power :	7W/12W/15W/18W
Input :	AC85-265V , 50 /60 HZ
Temperature range :	-20-50°C
Light source :	COB
Lumen :	80-110 LM/W
Colour Temperture :	3000K - 6500K/CCT
Colour Rendering Index :	CRI>80
Beam angle :	15°/24°/36°/55°
Power factor :	Pf>0.5 / Pf>0.9
Power efficiency :	92%
Housing material :	Die-casting Aluminium
Optical material:	Reflective cup+Lens
Lighning protection :	1.5-4KV
Protection class :	Ip20



KZ03-RD SERIES

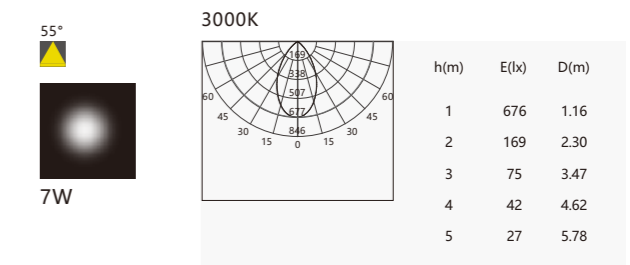
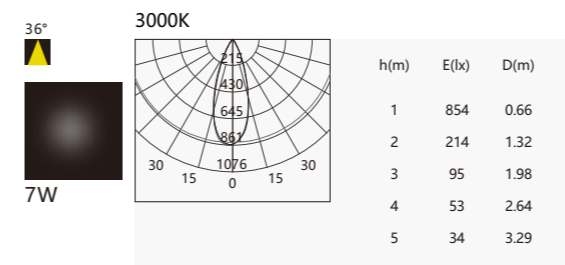
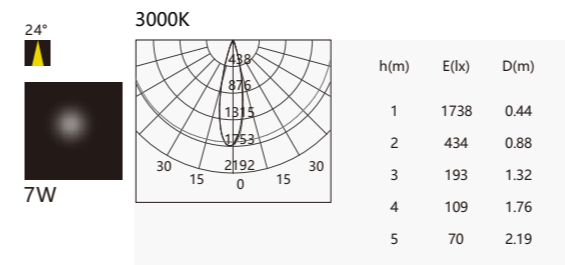
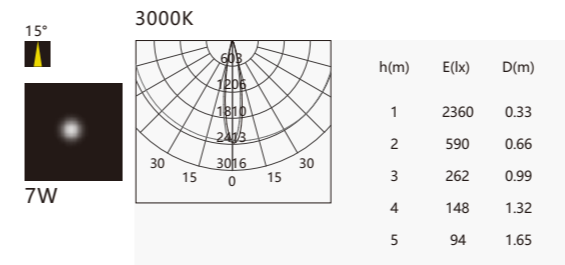
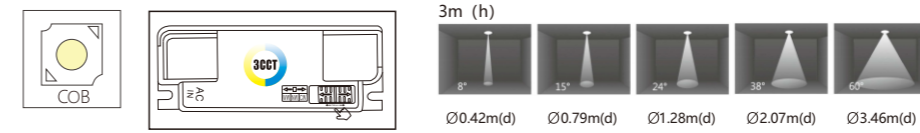

85-265V 50-60Hz	UGR≤6	LED	50000H Long Life
IP20	IP20	IP20	IP20
3000K Ra>80	4000K Ra>80	6500K Ra>80	
OSRAM	SAN AN	CREE	BRIDGELUX
	WH	BK	
SAND WH	MATT BK	SHINE BK	
UV BK	UV SL	UV GD	

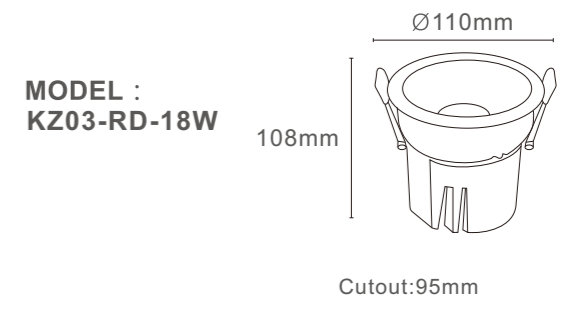
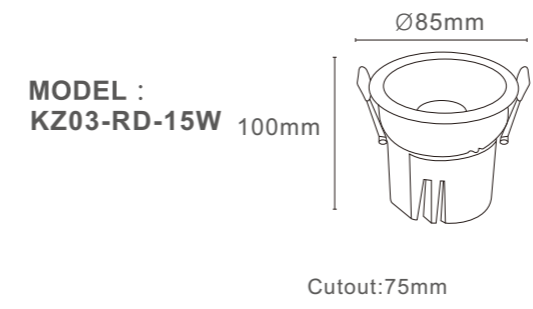
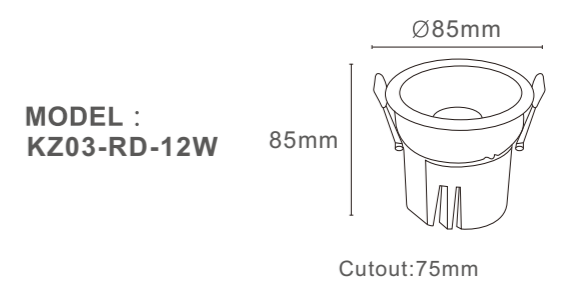
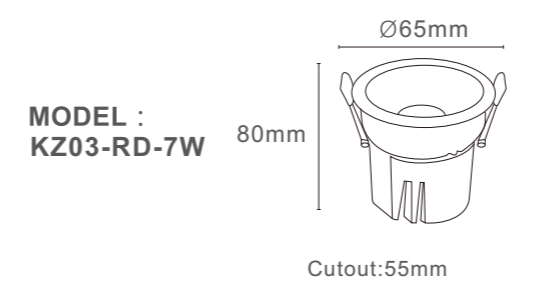



KZ03-SQ

TECHNICAL SPECIFICATIONS

Product Name :	COB Downlight
Model no:	KZ03-SQ
Power :	12W/2*12W/3*12W/4*12W
Input :	AC85-265V , 50 /60 HZ
Temperature range :	-20-50°C
Light source :	COB
Lumen :	80-110 LM/W
Colour Temperture :	3000K - 6500K/CCT
Colour Rendering Index :	CRI>80
Beam angle :	15°/24°/36°/55°
Power factor :	Pf>0.5 / Pf>0.9
Power efficiency :	92%
Housing material :	Die-casting Aluminium
Optical material:	Reflective cup
Lighning protection :	1.5-4KV
Protection class :	Ip20

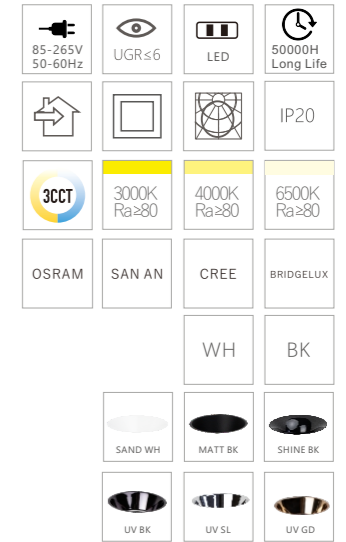
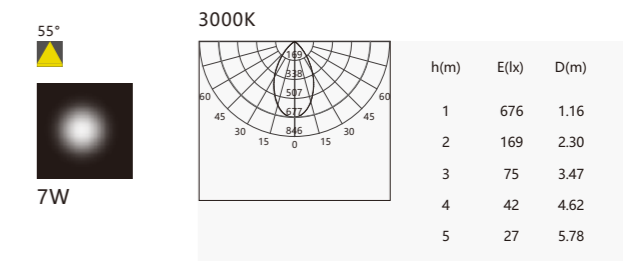
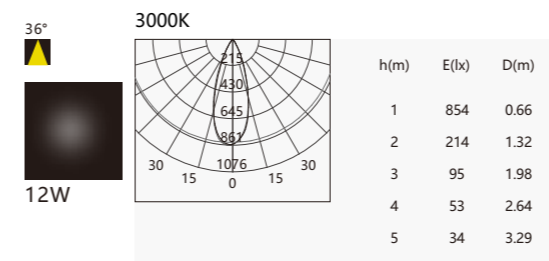
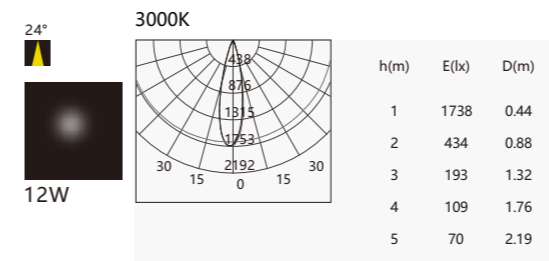
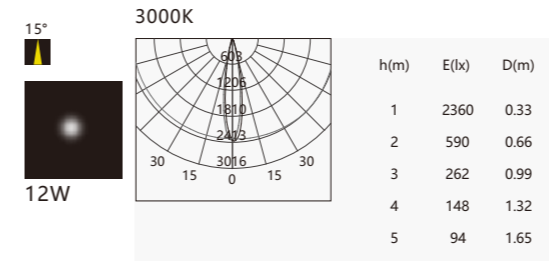
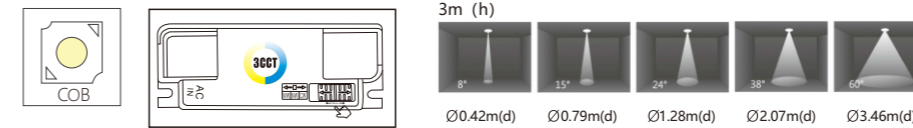

MODEL : KZ03-SQ-12W

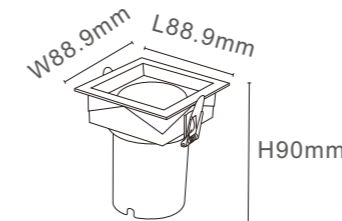

Cutout:L75*W75mm

MODEL : KZ03-SQ-3*12W



Cutout:L240*W75mm

MODEL : KZ03-SQ-2*12W



Cutout:L160*W75mm

MODEL : KZ03-SQ-4*12W



Cutout:L160*W160mm

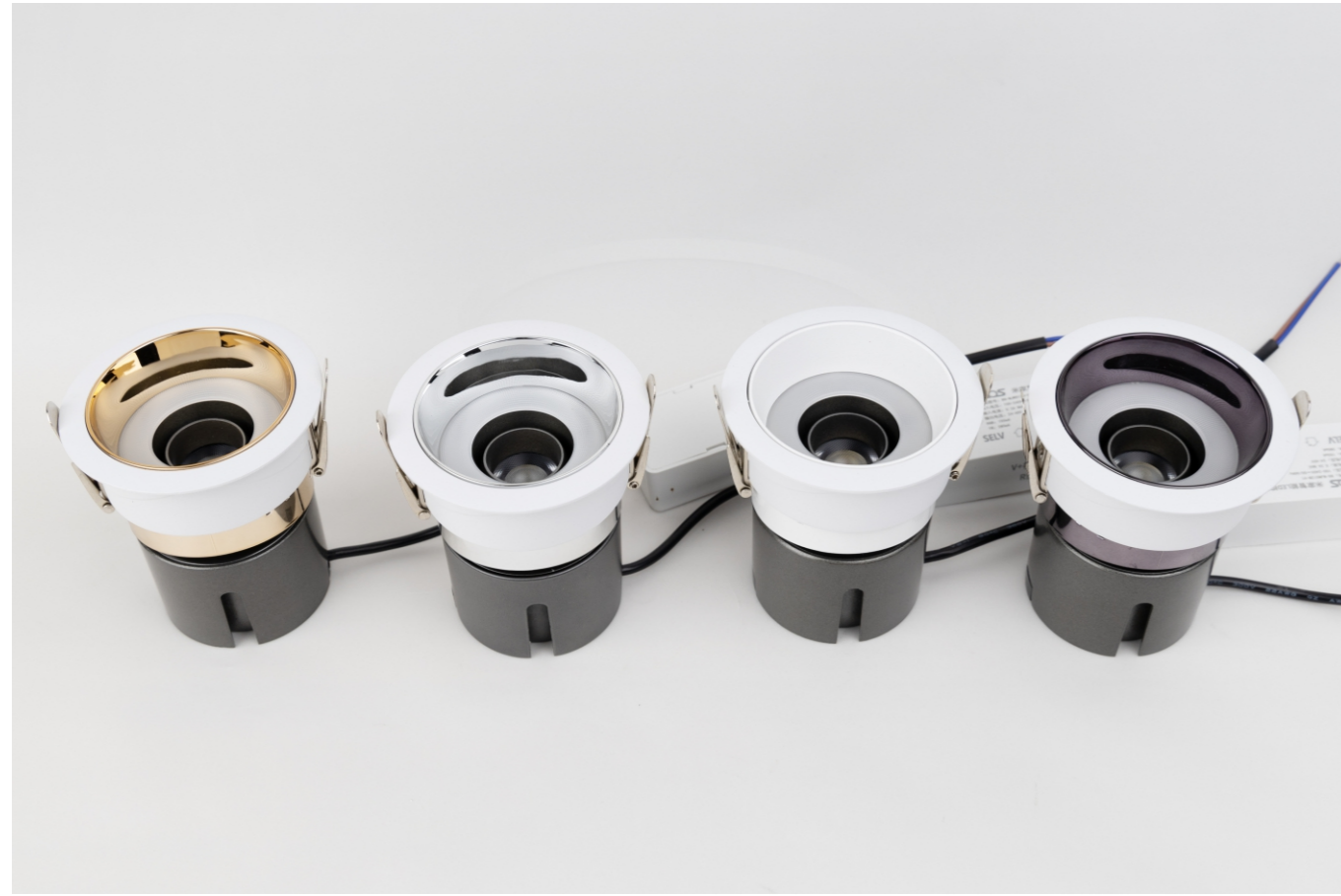

KZ04

TECHNICAL SPECIFICATIONS

Product Name :	COB Downlight
Model no:	KZ04
Power :	7W+12W
Input :	AC85-265V , 50 /60 HZ
Temperature range :	-20-50°C
Light source :	COB
Lumen :	80-110 LM/W
Colour Temperture :	3000K - 6500K/CCT
Colour Rendering Index :	CRI>80
Beam angle :	15°/24°/36°/55°
Power factor :	Pf>0.5 / Pf>0.9
Power efficiency :	92%
Housing material :	Die-casting Aluminium
Optical material:	Reflective cup+Lens
Lighning protection :	1.5-4KV
Protection class :	Ip20



KZ04 SERIES

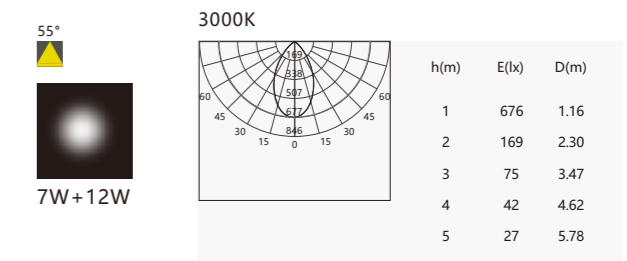
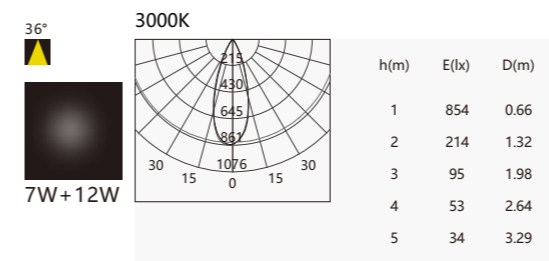
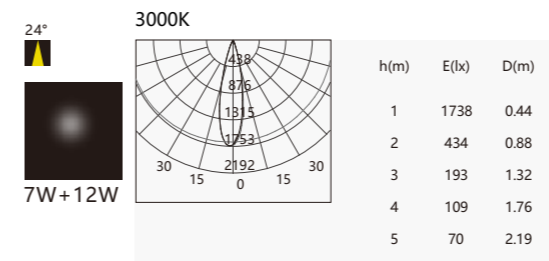
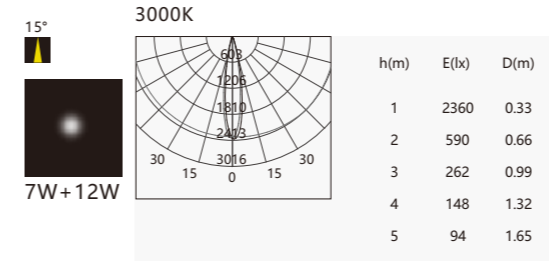
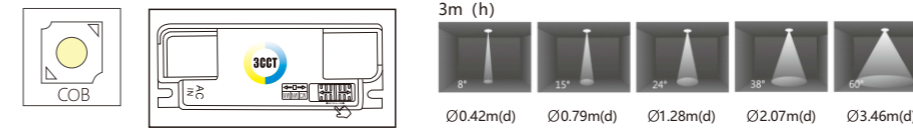

85-265V 50-60Hz	UGR≤6	LED	50000H Long Life
IP20	IP20	IP20	IP20
5000H Ra>80	3000K Ra>80	4000K Ra>80	6500K Ra>80
OSRAM	SAN AN	CREE	BRIDGELUX
	WH	BK	
SHINE WH	MATT BK	UV BK	UV SL
			UV GD

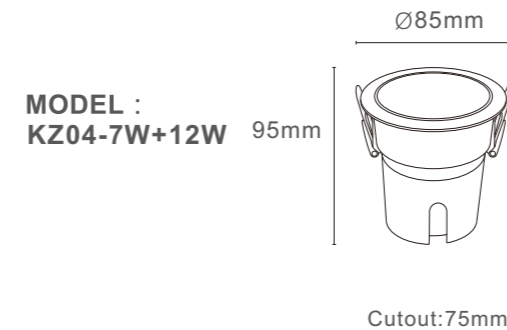

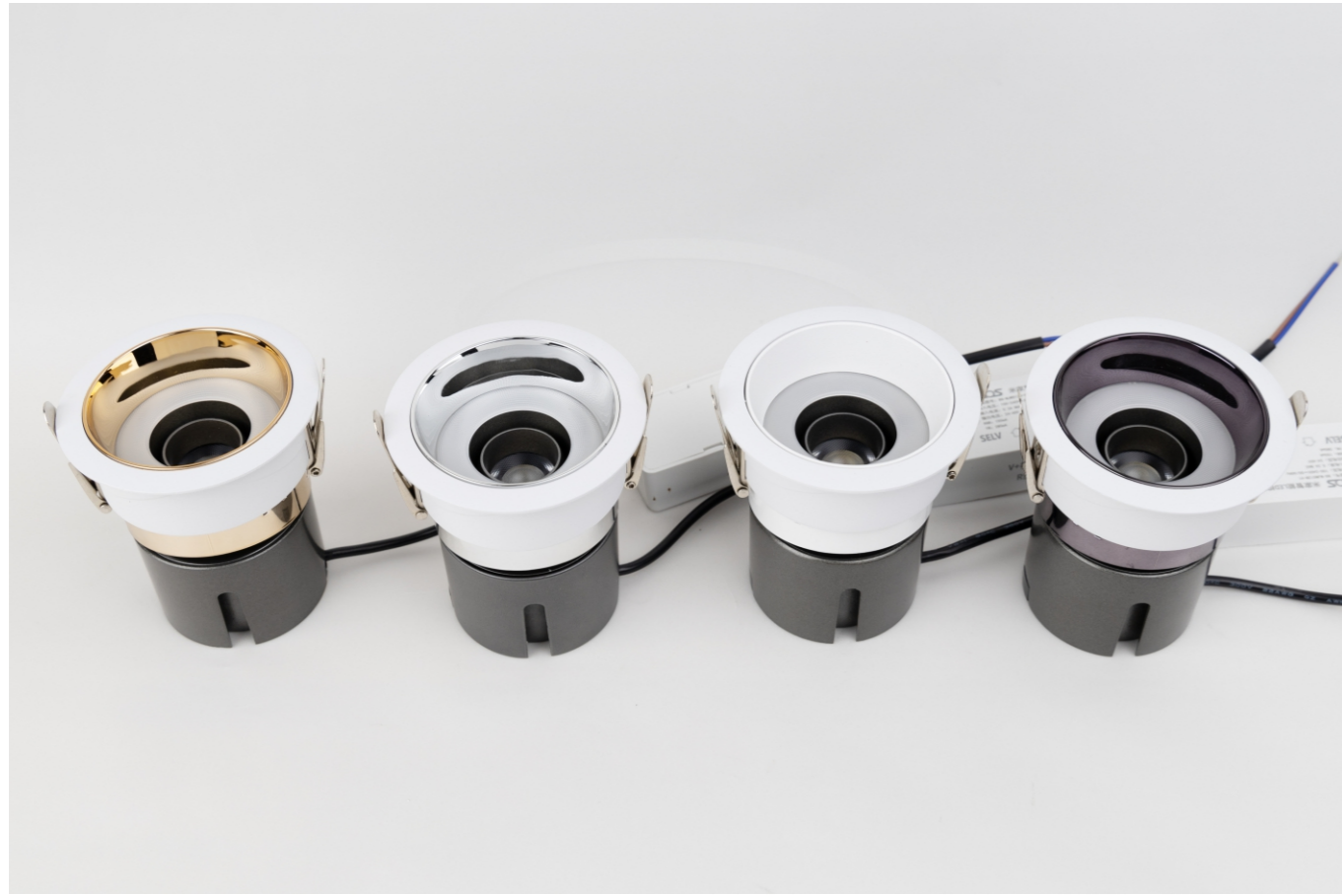

KZ04

TECHNICAL SPECIFICATIONS

Product Name :	COB Downlight
Model no:	KZ04
Power :	7W+12W
Input :	AC85-265V , 50 /60 HZ
Temperature range :	-20-50°C
Light source :	COB
Lumen :	80-110 LM/W
Colour Temperture :	3000K - 6500K/CCT
Colour Rendering Index :	CRI>80
Beam angle :	15°/24°/36°/55°
Power factor :	Pf>0.5 / Pf>0.9
Power efficiency :	92%
Housing material :	Die-casting Aluminium
Optical material:	Reflective cup+Lens
Lighning protection :	1.5-4KV
Protection class :	Ip20



KZ04 SERIES

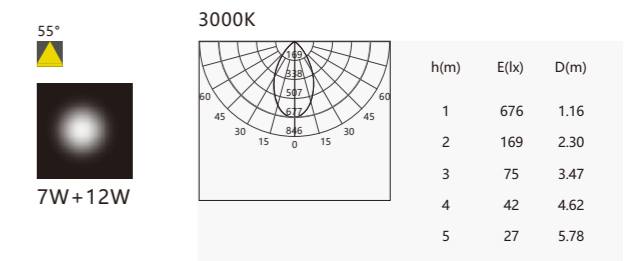
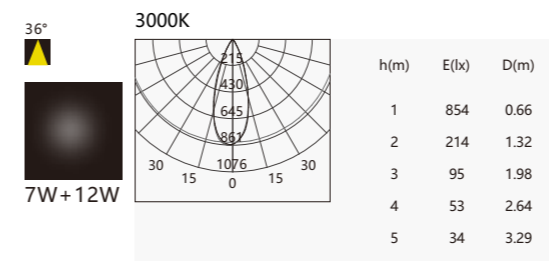
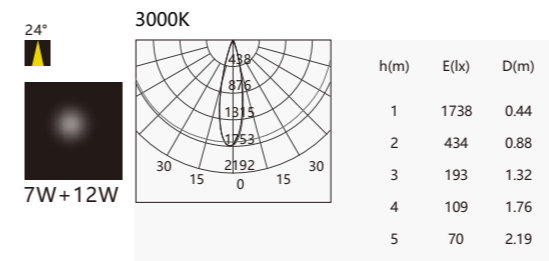
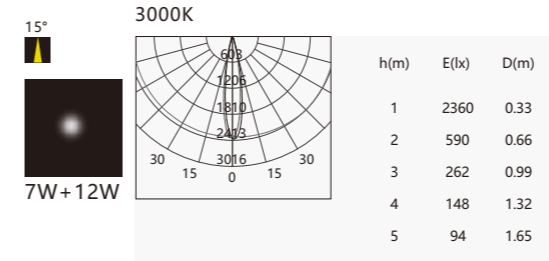
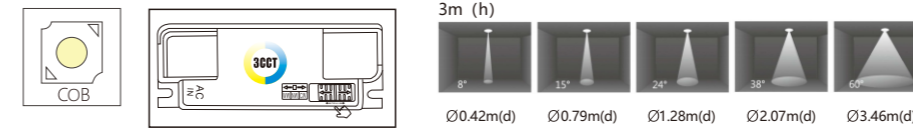

85-265V 50-60Hz	UGR≤6	LED	50000H Long Life
IP20	IP20	IP20	IP20
5000H Ra>80	3000K Ra>80	4000K Ra>80	6500K Ra>80
OSRAM	SAN AN	CREE	BRIDGELUX
SHINE WH	MATT BK	UV BK	UV SL
	WH	BK	UV GD

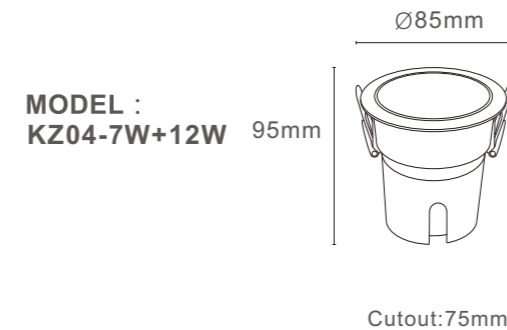



KZ05

TECHNICAL SPECIFICATIONS

Product Name :	COB Downlight
Model no:	KZ05
Power :	7W/12W/15W/18W
Input :	AC85-265V , 50 /60 HZ
Temperature range :	-20-50°C
Light source :	COB
Lumen :	80-110 LM/W
Colour Temperature :	3000K - 6500K/CCT
Colour Rendering Index :	CRI>80
Beam angle :	15°/24°/36°/55°
Power factor :	Pf>0.5 / Pf>0.9
Power efficiency :	92%
Housing material :	Die-casting Aluminium
Optical material:	Reflective cup+Lens
Lighning protection :	1.5-4KV
Protection class :	Ip20



KZ05 SERIES

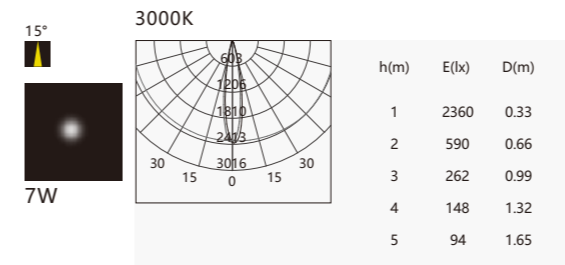
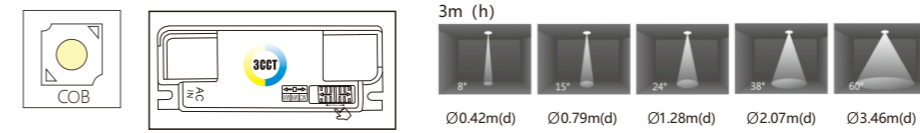

85-265V 50-60Hz	UGR≤6	LED	50000H Long Life
IP20	3000K Ra>80	4000K Ra>80	6500K Ra>80
OSRAM	SAN AN	CREE	BRIDGELUX
	WH	BK	
SHINE WH	SHINE BK	MATT BK	
UV BK	UV SL	UV GD	

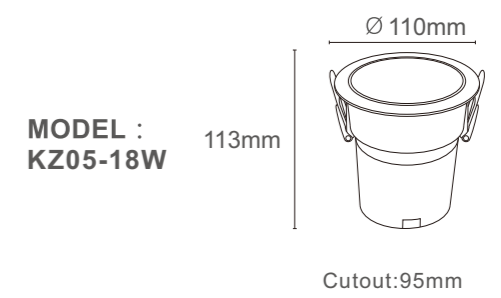
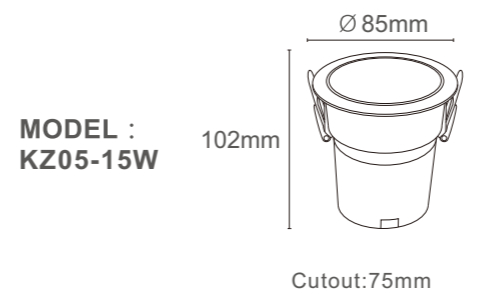
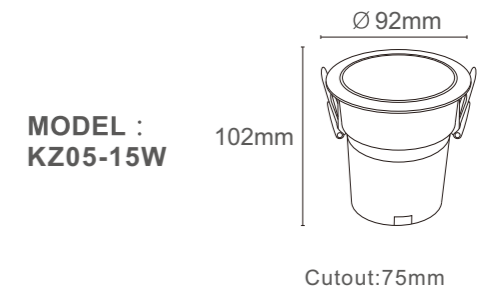
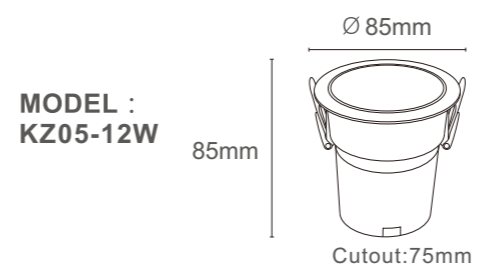
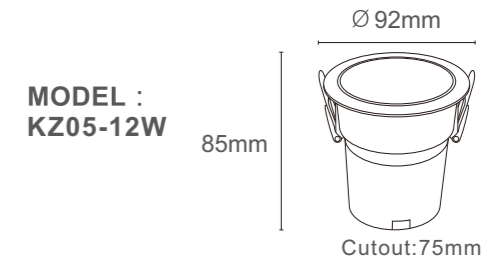
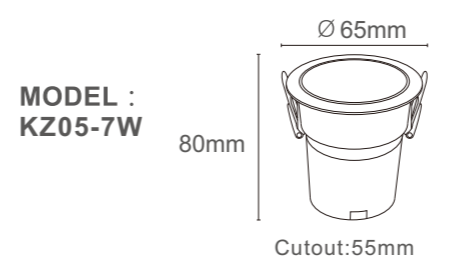



XG-CS101

TECHNICAL SPECIFICATIONS

Product Name :	SMD Downlight
Model no:	XG-CS101
Power :	7W/12W
Input :	AC85-265V , 50 /60 HZ
Temperature range :	-20-50°C
Light source :	SMD
Lumen :	80-110 LM/W
Colour Temperture :	3000K - 6500K/CCT
Colour Rendering Index :	CRI>80
Beam angle :	110°
Power factor :	Pf>0.5 / Pf>0.9
Power efficiency :	92%
Housing material :	Die-casting Aluminium
Cover material :	PC
Lighning protection :	1.5-4KV
Protection class :	Ip20



XG-CS101 SERIES

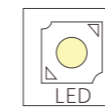

3m (h)

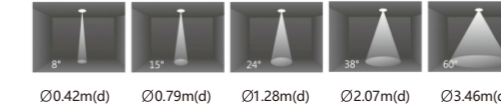

Ø0.42m(d) Ø0.79m(d) Ø1.28m(d) Ø2.07m(d) Ø3.46m(d)

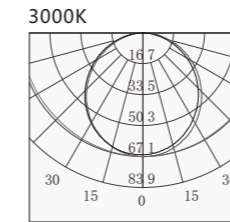

h(m)	E(lx)	D(m)
1	672	2.94
2	168	5.89
3	75	8.83
4	42	11.78
5	27	14.72

85-265V 50-60Hz	UGR≤6	LED	50000H Long Life
IP20	IP20	IP20	IP20
3 CCT	3000K Ra>80	4000K Ra>80	6500K Ra>80
OSRAM	SAN AN	CREE	BRIDGELUX
	WH	BK	

MODEL :
XG-CS101-7W

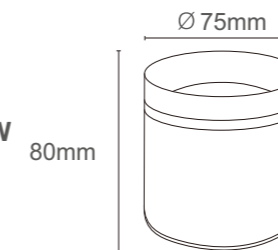

MODEL :
XG-CS101-12W

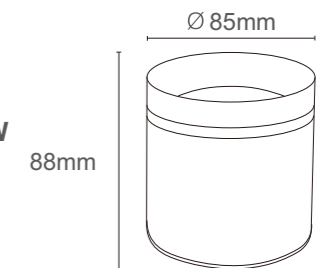



XG-CS102 SERIES

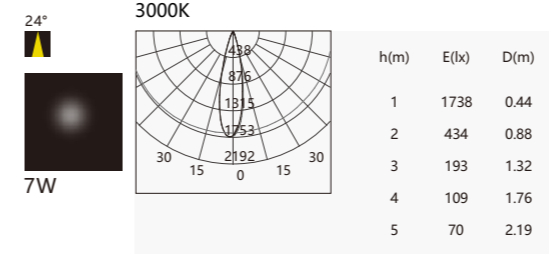
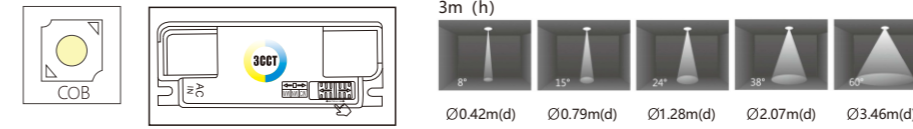

85-265V 50-60Hz	UGR≤6	LED	50000H Long Life
IP20	IP20	IP20	IP20
3000K Ra>80	4000K Ra>80	6500K Ra>80	
OSRAM	SAN AN	CREE	BRIDGELUX
	WH	BK	

XG-CS102

TECHNICAL SPECIFICATIONS

Product Name :	COB Downlight
Model no:	XG-CS102
Power :	7W/12W
Input :	AC85-265V , 50 /60 HZ
Temperature range :	-20-50°C
Light source :	COB
Lumen :	80-110 LM/W
Colour Temperture :	3000K - 6500K/CCT
Colour Rendering Index :	CRI>80
Beam angle :	24°
Power factor :	Pf>0.5 / Pf>0.9
Power efficiency :	92%
Housing material :	Die-casting Aluminium
Optical material:	Lens
Lighning protection :	1.5-4KV
Protection class :	Ip20



MODEL :
XG-CS102-7W

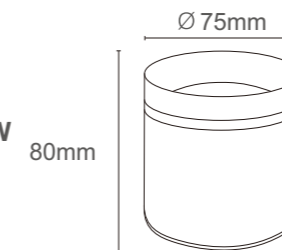

MODEL :
XG-CS102-12W

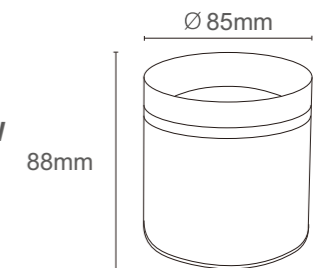



XG-CS103 SERIES

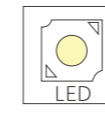

3m (h)

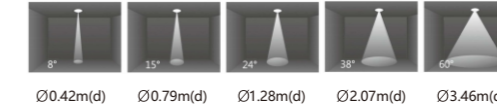

Ø0.42m(d) Ø0.79m(d) Ø1.28m(d) Ø2.07m(d) Ø3.46m(d)

110°



3000K

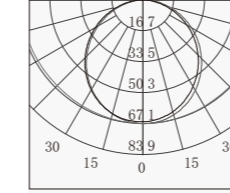

h(m)	E lx	D(m)
1	672	2.94
2	168	5.89
3	75	8.83
4	42	11.78
5	27	14.72

85-265V 50-60Hz	UGR≤6	LED	50000H Long Life
IP20	IP20	IP20	IP20
3 CCT	3000K Ra>80	4000K Ra>80	6500K Ra>80
OSRAM	SAN AN	CREE	BRIDGELUX
	WH	BK	

XG-CS103

TECHNICAL SPECIFICATIONS

Product Name :	SMD Downlight
Model no:	XG-CS103
Power :	5W/7W/12W
Input :	AC85-265V , 50 /60 HZ
Temperature range :	-20-50°C
Light source :	SMD
Lumen :	80-110 LM/W
Colour Temperture :	3000K - 6500K/CCT
Colour Rendering Index :	CRI>80
Beam angle :	110°
Power factor :	Pf>0.5 / Pf>0.9
Power efficiency :	92%
Housing material :	Die-casting Aluminium
Cover material :	PC
Lighning protection :	1.5-4KV
Protection class :	Ip20



MODEL :
XG-CS103-5W

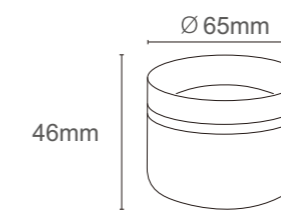

MODEL :
XG-CS103-7W

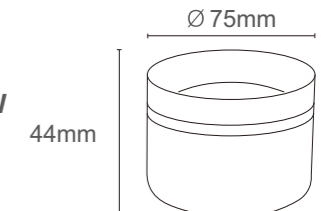

MODEL :
XG-CS103-12W

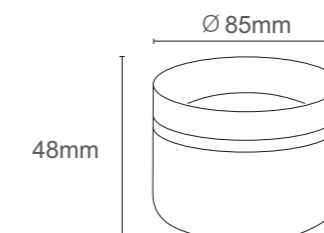



CDS100

TECHNICAL SPECIFICATIONS

Product Name :	COB Downlight
Model no:	CDS100
Power :	12W/12W*2/12W*3/12W*4
Input :	AC85-265V , 50 /60 HZ
Temperature range :	-20-50°C
Light source :	COB
Lumen :	80-110 LM/W
Colour Temperture :	3000K - 6500K/CCT
Colour Rendering Index :	CRI>80
Beam angle :	12°/24°/38°/60°
Power factor :	Pf>0.5 / Pf>0.9
Power efficiency :	92%
Housing material :	Die-casting Aluminium
Optical material:	Lens
Lighning protection :	1.5-4KV
Protection class :	Ip20



CDS100 SERIES

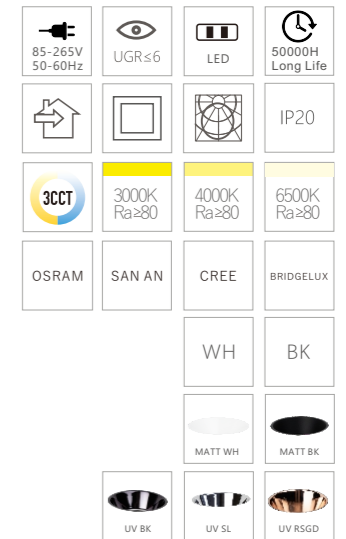
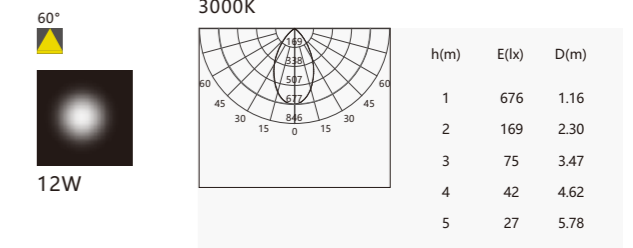
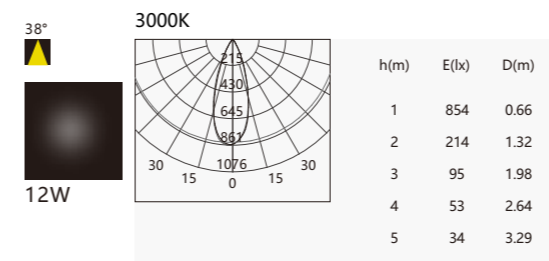
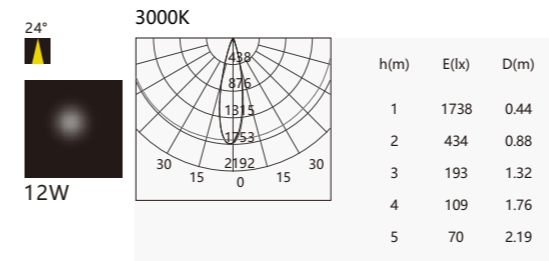
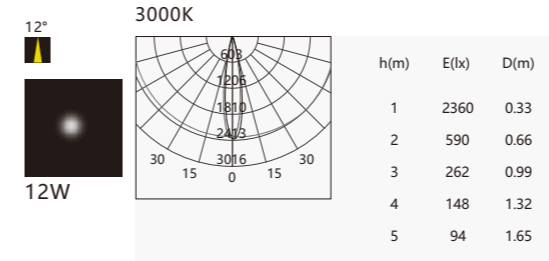
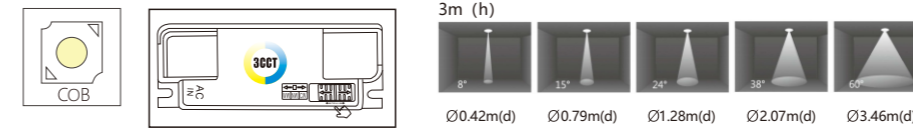

MODEL : CDS100-12W

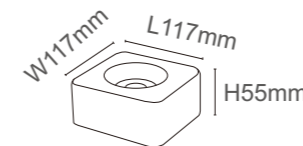

MODEL : CDS100-12W*2

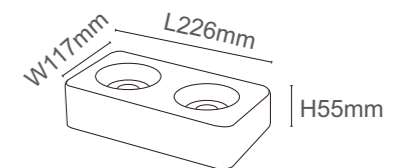

MODEL : CDS100-12W*3

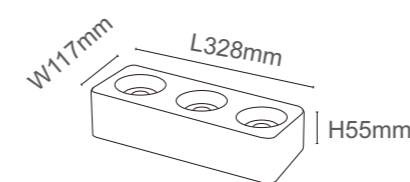

MODEL : CDS100-12W*4

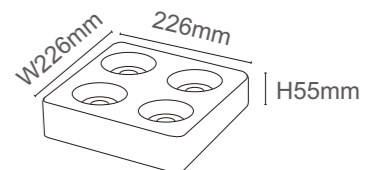



CDS202

TECHNICAL SPECIFICATIONS

Product Name :	COB Downlight
Model no:	CDS202
Power :	12W/18W/30W/40W/48W/60W
Input :	AC85-265V , 50 /60 HZ
Temperature range :	-20-50°C
Light source :	COB
Lumen :	80-110 LM/W
Colour Temperture :	3000K - 6500K/CCT
Colour Rendering Index :	CRI>80
Beam angle :	12°/24°/38°/60°
Power factor :	Pf>0.5 / Pf>0.9
Power efficiency :	92%
Housing material :	Die-casting Aluminium
Optical material:	Reflective cup+Lens
Lighning protection :	1.5-4KV
Protection class :	Ip20



CDS202 SERIES

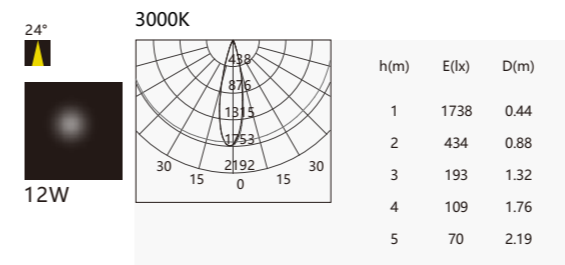
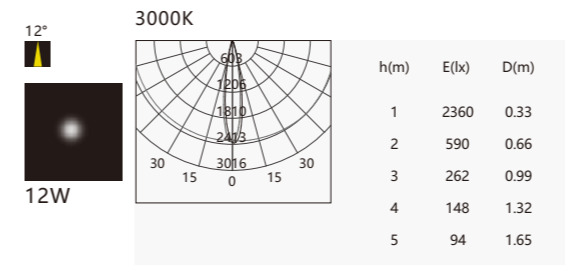
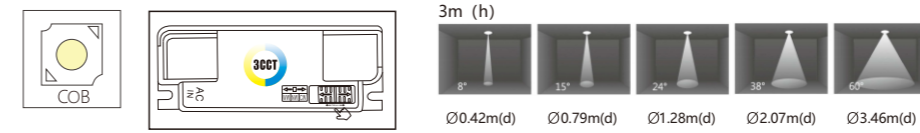

85-265V 50-60Hz	UGR≤6	LED	50000H Long Life
IP20	3000K Ra>80	4000K Ra>80	6500K Ra>80
OSRAM	SAN AN	CREE	BRIDGELUX
	WH	BK	
SHINE WH	SHINE BK	MATT BK	MATT SL
UV BK	UV SL	UV GD	UV RSGD

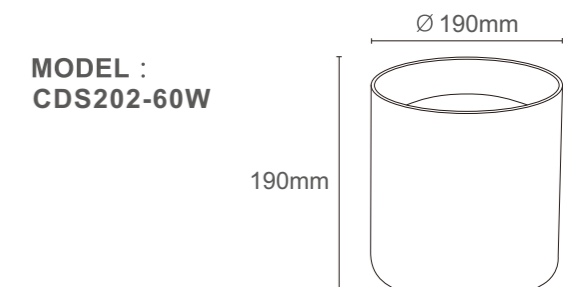
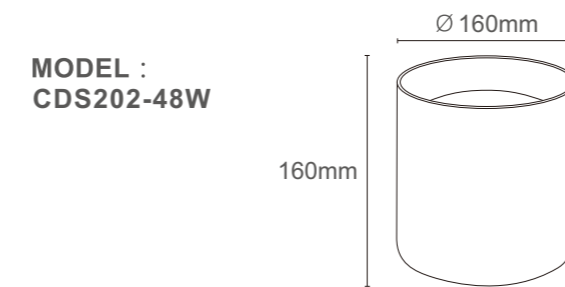
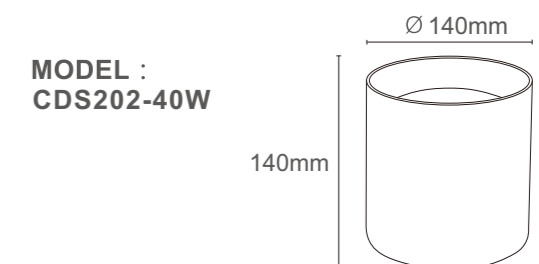
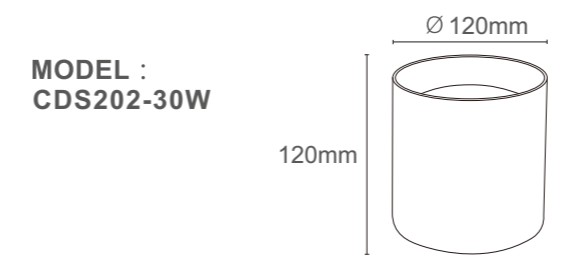
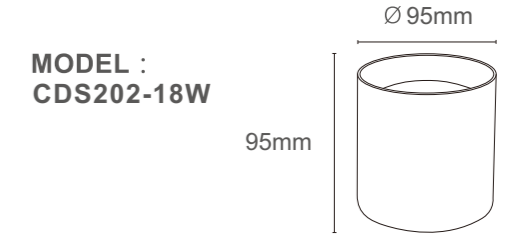
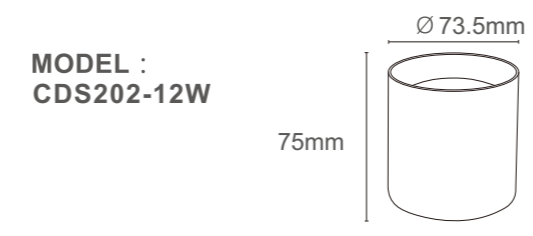



CDS203

TECHNICAL SPECIFICATIONS

Product Name :	COB Downlight
Model no:	CDS203
Power :	7W/12W/18W/30W
Input :	AC85-265V , 50 /60 HZ
Temperature range :	-20-50°C
Light source :	COB
Lumen :	80-110 LM/W
Colour Temperture :	3000K - 6500K/CCT
Colour Rendering Index :	CRI>80
Beam angle :	12°/24°/38°/55°
Power factor :	Pf>0.5 / Pf>0.9
Power efficiency :	92%
Housing material :	Die-casting Aluminium
Optical material:	Reflective cup+Lens
Lighning protection :	1.5-4KV
Protection class :	Ip20

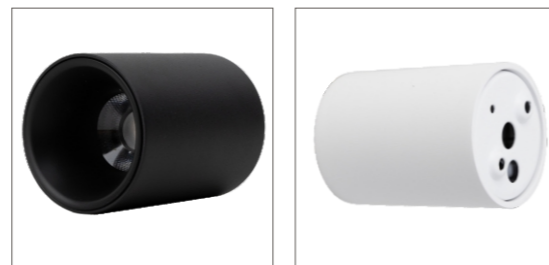

CDS203 SERIES

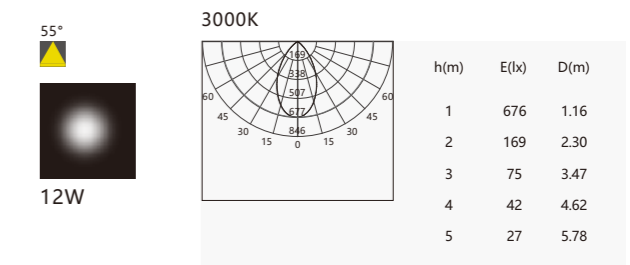
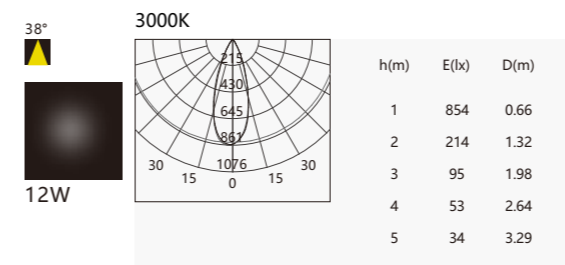
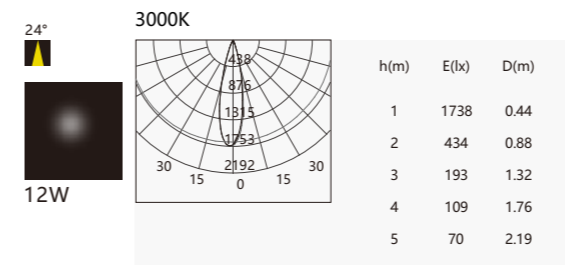
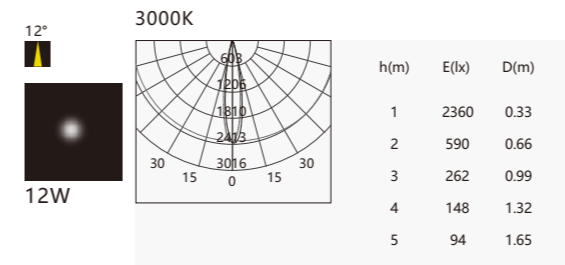
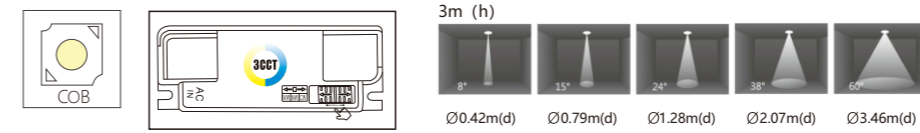

- 85-265V 50-60Hz
- UGR≤6
- LED
- 50000H Long Life
- IP20
- 3000K Ra>80
- 4000K Ra>80
- 6500K Ra>80
- OSRAM
- SAN AN
- CREE
- BRIDGELUX
- WH
- BK
- MATT WH
- MATT BK
- MATT SL
- UV BK
- UV SL
- UV GD

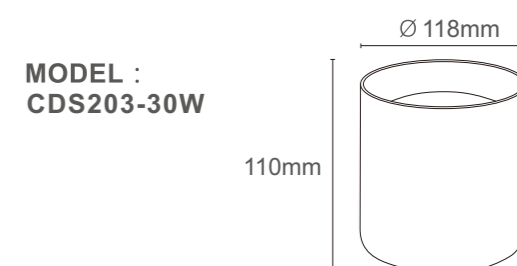
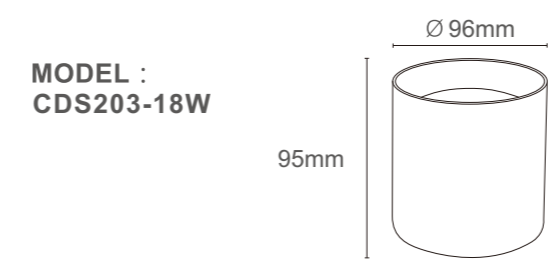
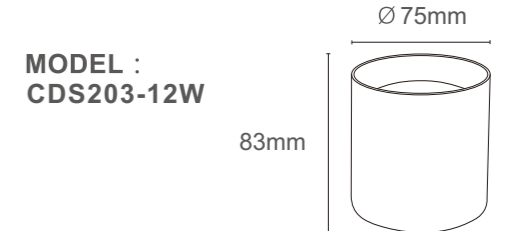
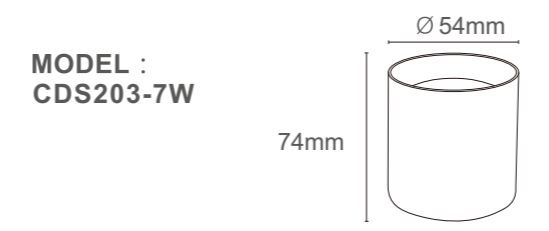



CDS204

TECHNICAL SPECIFICATIONS

Product Name :	SMD Downlight
Model no:	CDS204
Power :	7W/12W/18W/20W/24W/36W
Input :	AC85-265V , 50 /60 HZ
Temperature range :	-20-50°C
Light source :	SMD
Lumen :	80-110 LM/W
Colour Temperture :	3000K - 6500K/CCT
Colour Rendering Index :	CRI>80
Beam angle :	110°
Power factor :	Pf>0.5 / Pf>0.9
Power efficiency :	92%
Housing material :	Die-casting Aluminium
Cover material :	PC
Lighning protection :	1.5-4KV
Protection class :	Ip20



CDS204 SERIES

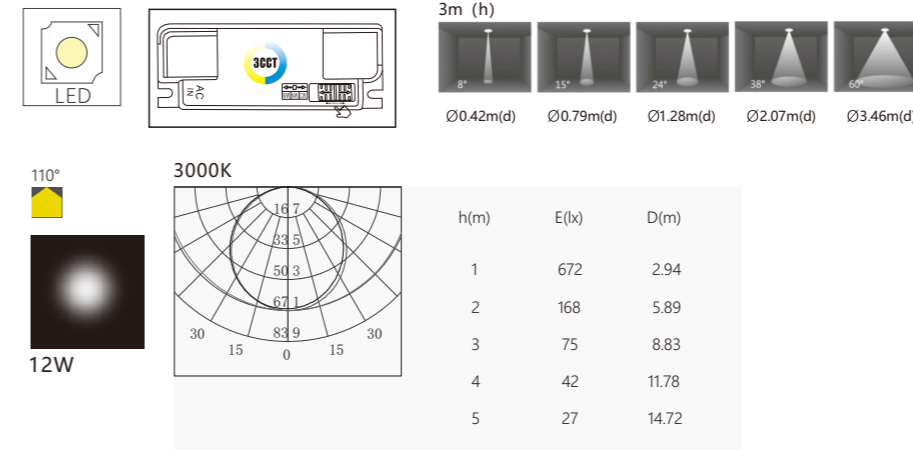

85-265V 50-60Hz	UGR≤6	LED	50000H Long Life
IP20	3000K Ra>80	4000K Ra>80	6500K Ra>80
OSRAM	SAN AN	CREE	BRIDGELUX
	WH	BK	

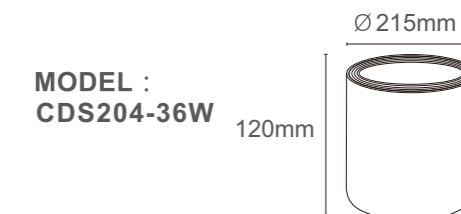
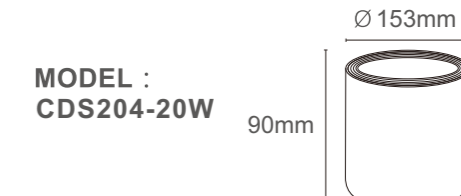
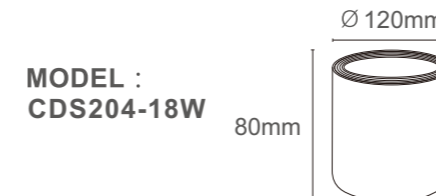
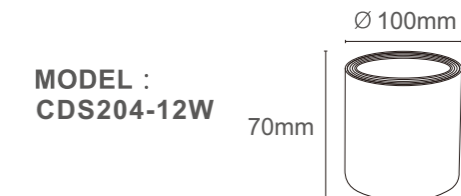
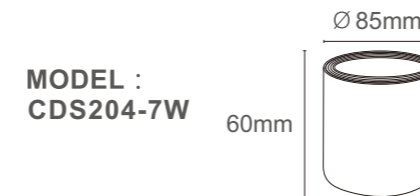



CDS205

TECHNICAL SPECIFICATIONS

Product Name :	COB Downlight
Model no:	CDS205
Power :	7W/15W
Input :	AC85-265V , 50 /60 HZ
Temperature range :	-20-50°C
Light source :	COB
Lumen :	80-110 LM/W
Colour Temperture :	3000K - 6500K/CCT
Colour Rendering Index :	CRI>80
Beam angle :	15°/24°/36°/60°
Power factor :	Pf>0.5 / Pf>0.9
Power efficiency :	92%
Housing material :	Die-casting Aluminium
Optical material:	Reflective cup+Lens
Lighning protection :	1.5-4KV
Protection class :	Ip20

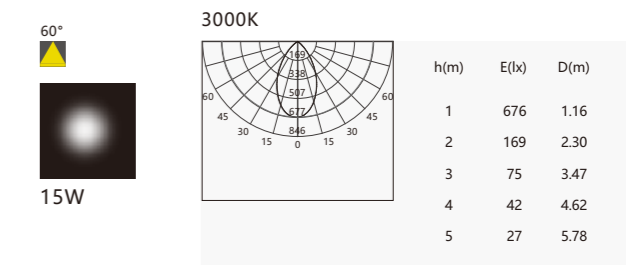
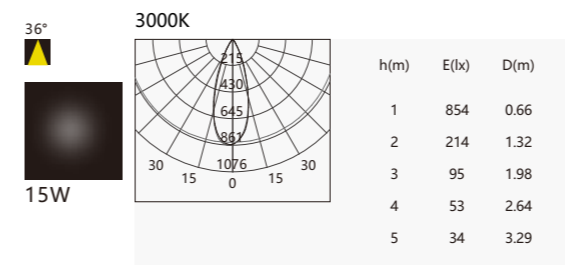
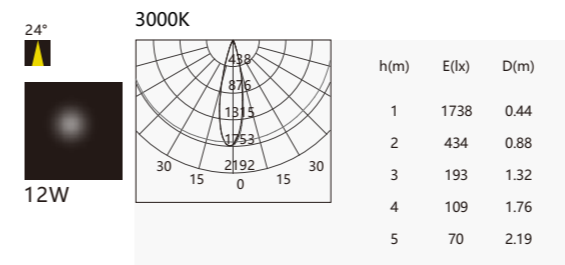
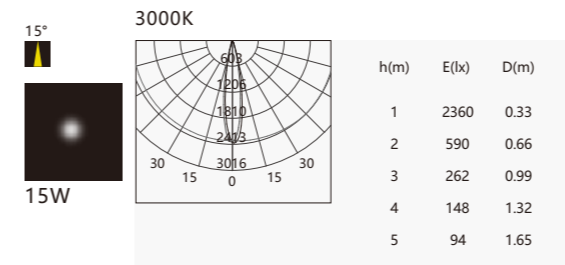
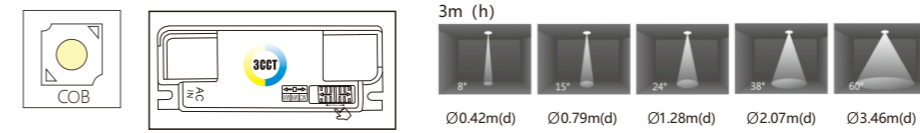

85-265V 50-60Hz	UGR≤6	LED	50000H Long Life
IP20	IP20	IP20	IP20
3000K Ra>80	4000K Ra>80	6500K Ra>80	
OSRAM	SAN AN	CREE	BRIDGELUX
	WH	BK	
SHINE WH	MATT BK	MATT SL	
UV BK	UV SL	UV GD	

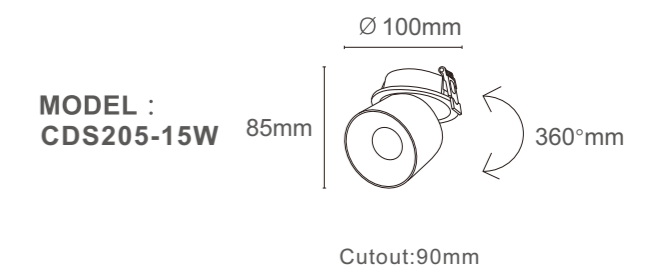
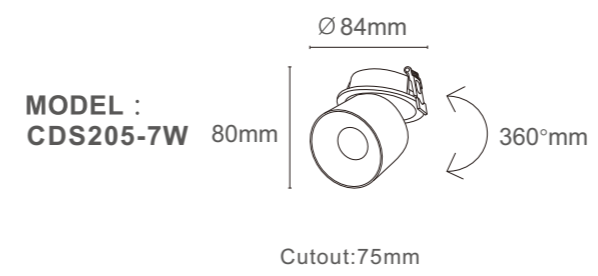



CDS206 SERIES

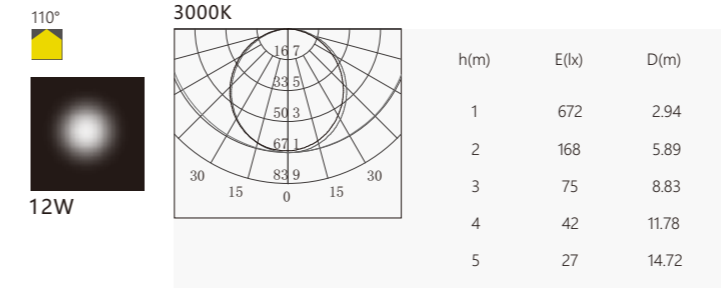
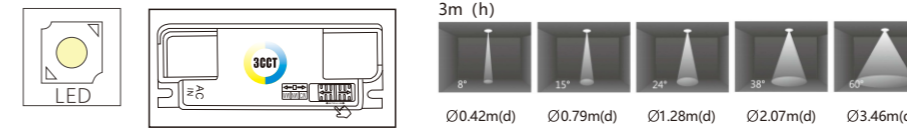

85-265V 50-60Hz	UGR≤6	LED	50000H Long Life
IP20	3 CCT	3000K Ra>80	4000K Ra>80
OSRAM	SAN AN	CREE	BRIDGELUX
	WH	BK	

CDS206

TECHNICAL SPECIFICATIONS

Product Name :	SMD Downlight
Model no:	CDS206
Power :	7W
Input :	AC85-265V , 50 /60 HZ
Temperature range :	-20-50°C
Light source :	SMD
Lumen :	80-110 LM/W
Colour Temperture :	3000K - 6500K/CCT
Colour Rendering Index :	CRI>80
Beam angle :	110°
Power factor :	Pf>0.5 / Pf>0.9
Power efficiency :	92%
Housing material :	Die-casting Aluminium
Cover material :	PC
Lighning protection :	1.5-4KV
Protection class :	Ip20

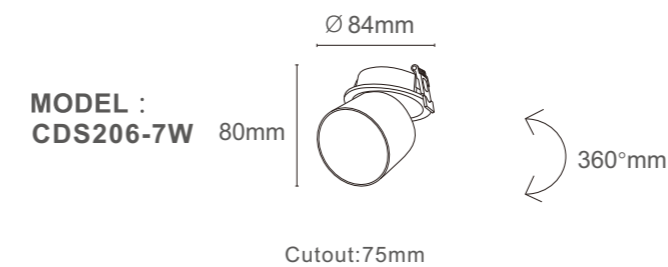



CDS207

TECHNICAL SPECIFICATIONS

Product Name :	COB Downlight
Model no:	CDS207
Power :	7W/15W
Input :	AC85-265V , 50 /60 HZ
Temperature range :	-20-50°C
Light source :	COB
Lumen :	80-110 LM/W
Colour Temperture :	3000K - 6500K/CCT
Colour Rendering Index :	CRI>80
Beam angle :	15°/24°/36°/60°
Power factor :	Pf>0.5 / Pf>0.9
Power efficiency :	92%
Housing material :	Die-casting Aluminium
Optical material:	Reflective cup+Lens
Lighning protection :	1.5-4KV
Protection class :	Ip20



CDS207 SERIES

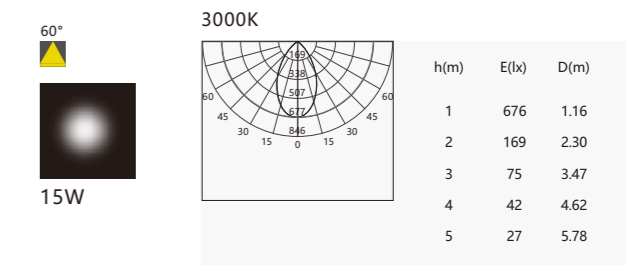
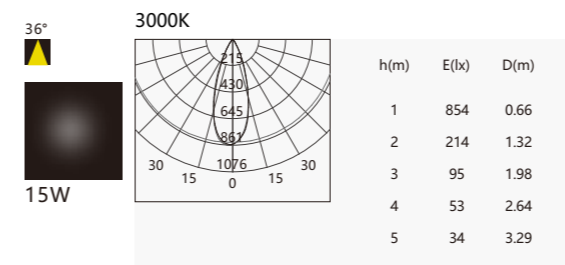
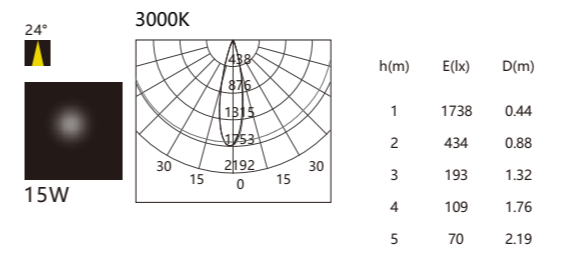
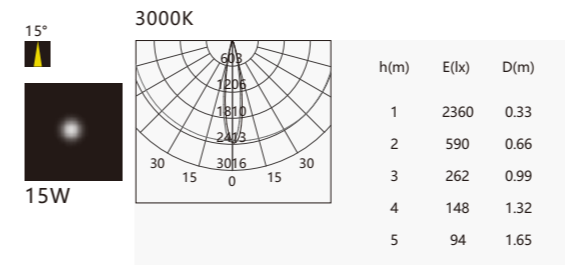
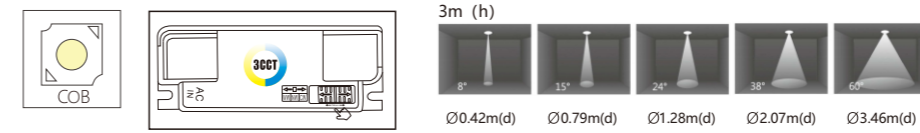

85-265V 50-60Hz	UGR≤6	LED	50000H Long Life
IP20	3000K Ra>80	4000K Ra>80	6500K Ra>80
OSRAM	SAN AN	CREE	BRIDGELUX
	WH	BK	
SHINE WH	MATT BK	MATT SL	
UV BK	UV SL	UV RSGD	

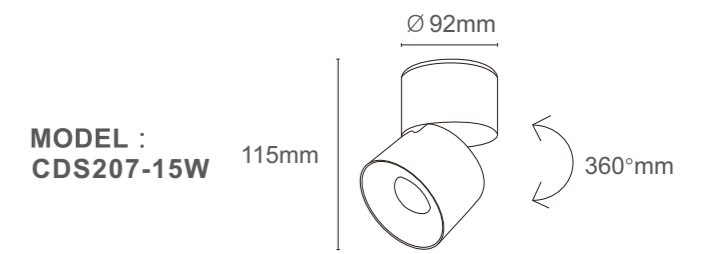
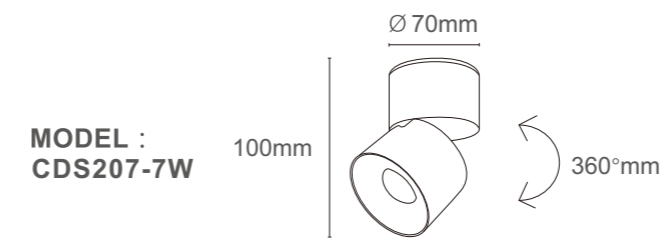



CDS208 SERIES

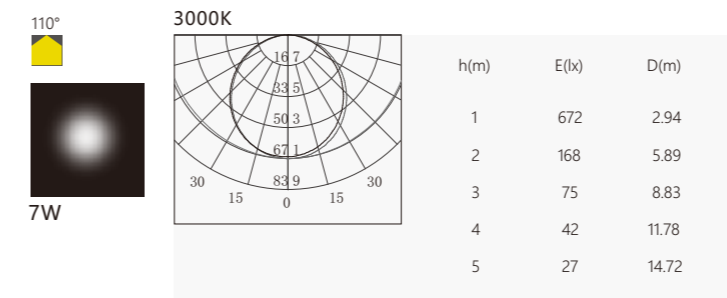
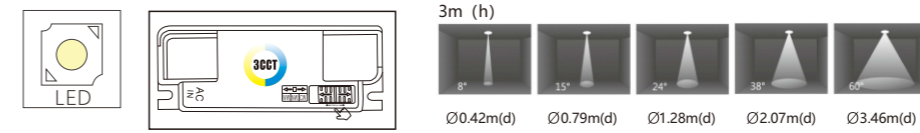

85-265V 50-60Hz	UGR≤6	LED	50000H Long Life
IP20	IP20	IP20	IP20
3CCT	3000K Ra>80	4000K Ra>80	6500K Ra>80
OSRAM	SAN AN	CREE	BRIDGELUX
	WH	BK	

CDS208

TECHNICAL SPECIFICATIONS

Product Name :	SMD Downlight
Model no:	CDS208
Power :	18W/30W
Input :	AC85-265V , 50 /60 HZ
Temperature range :	-20-50°C
Light source :	SMD
Lumen :	80-110 LM/W
Colour Temperture :	3000K - 6500K/CCT
Colour Rendering Index :	CRI>80
Beam angle :	110°
Power factor :	Pf>0.5 / Pf>0.9
Power efficiency :	92%
Housing material :	Die-casting Aluminium
Cover material :	PC
Lighning protection :	1.5-4KV
Protection class :	Ip20

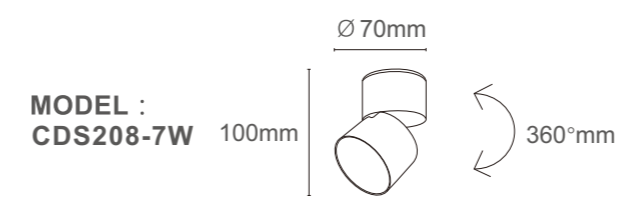



CDS209

TECHNICAL SPECIFICATIONS

Product Name :	COB Downlight
Model no:	CDS209
Power :	7W/15W
Input :	AC85-265V , 50 /60 HZ
Temperature range :	-20-50°C
Light source :	COB
Lumen :	80-110 LM/W
Colour Temperture :	3000K - 6500K/CCT
Colour Rendering Index :	CRI>80
Beam angle :	15°/24°/36°/60°
Power factor :	Pf>0.5 / Pf>0.9
Power efficiency :	92%
Housing material :	Die-casting Aluminium
Optical material:	Reflective cup+Lens
Lighning protection :	1.5-4KV
Protection class :	Ip20



CDS209 SERIES

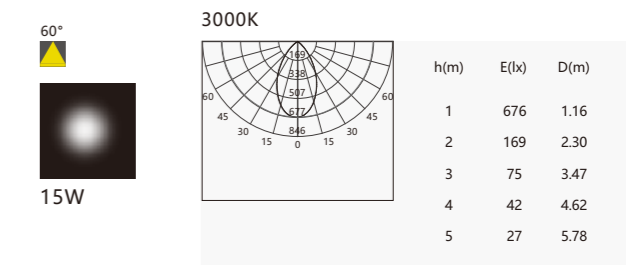
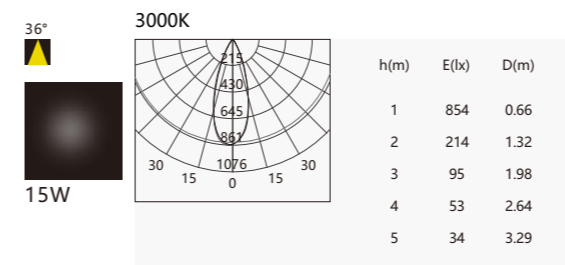
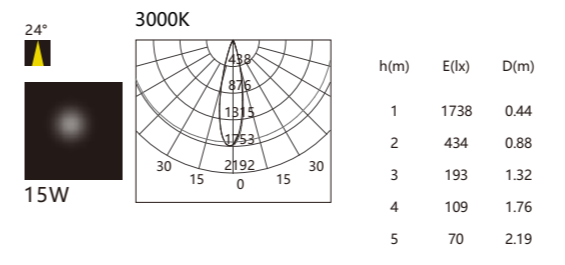
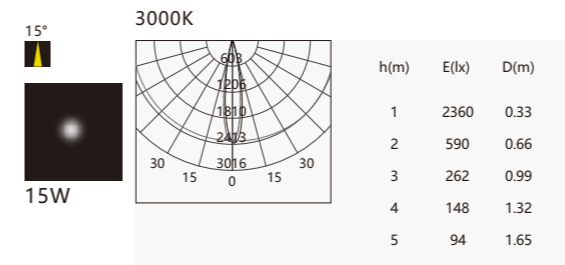
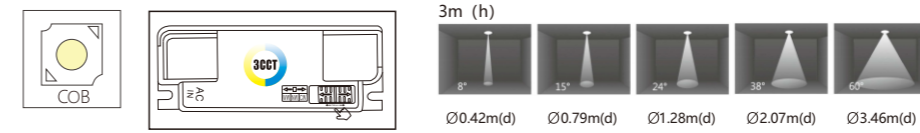

- 85-265V 50-60Hz
- UGR≤6
- LED
- 50000H Long Life
- IP20
- 3000K Ra>80
- 4000K Ra>80
- 6500K Ra>80
- OSRAM
- SAN AN
- CREE
- BRIDGELUX
- WH
- BK
- MATT BK
- MATT SL
- UV BK
- UV SL
- UV RSGD

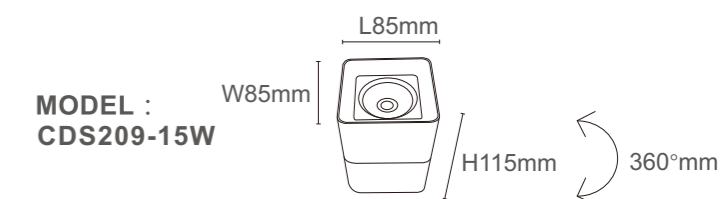
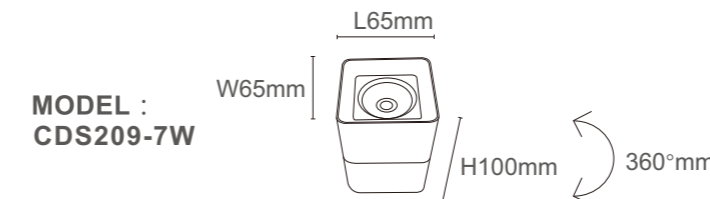



CDS210

TECHNICAL SPECIFICATIONS

Product Name :	COB Downlight
Model no:	CDS210
Power :	10W/20W/30W/40W
Input :	AC85-265V , 50 /60 HZ
Temperature range :	-20-50°C
Light source :	COB
Lumen :	80-110 LM/W
Colour Temperture :	3000K - 6500K/CCT
Colour Rendering Index :	CRI>80
Beam angle :	10°/20°/30°
Power factor :	Pf>0.5 / Pf>0.9
Power efficiency :	92%
Housing material :	Die-casting Aluminium
Optical material:	Lens
Lighning protection :	1.5-4KV
Protection class :	Ip20



CDS210 SERIES

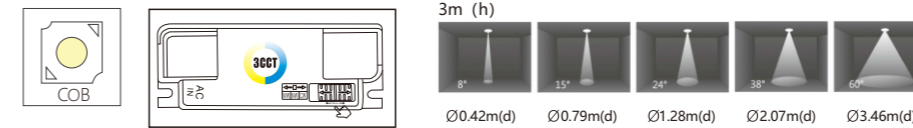

85-265V 50-60Hz	UGR≤6	LED	50000H Long Life
IP20	3000K Ra>80	4000K Ra>80	6500K Ra>80
OSRAM	SAN AN	CREE	BRIDGELUX
WH	BK	MATT WH	MATT BK

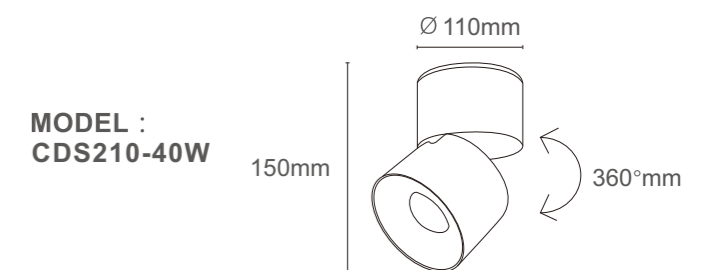
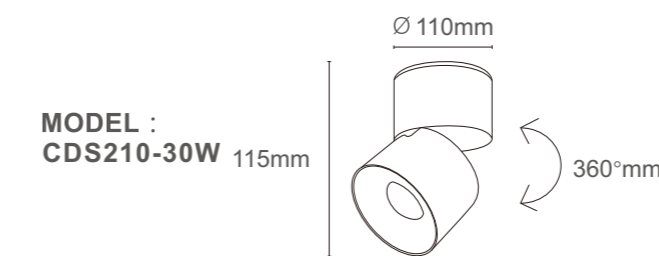
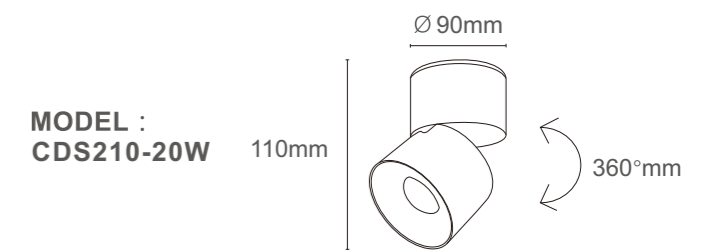
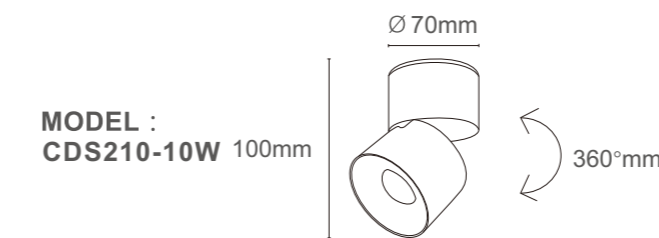
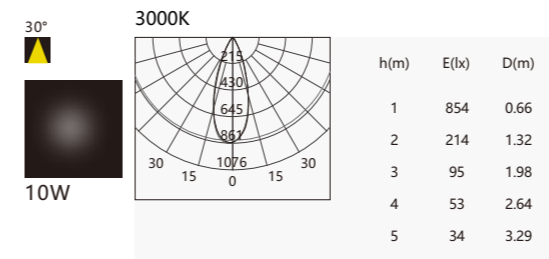
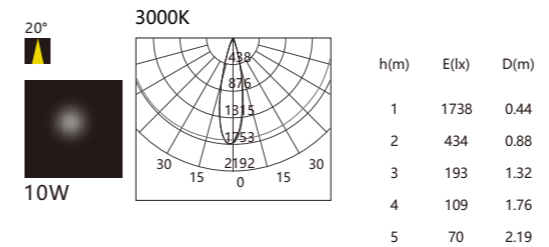
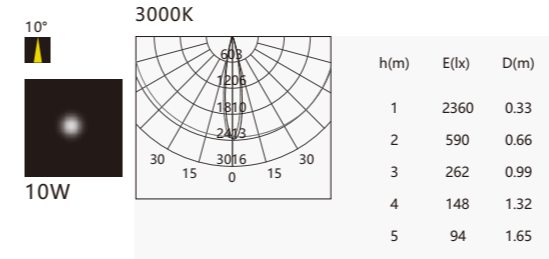



CDS211

TECHNICAL SPECIFICATIONS

Product Name :	COB Downlight
Model no:	CDS211
Power :	12W/20W
Input :	AC85-265V , 50 /60 HZ
Temperature range :	-20-50°C
Light source :	COB
Lumen :	80-110 LM/W
Colour Temperture :	3000K - 6500K/CCT
Colour Rendering Index :	CRI>80
Beam angle :	15°/24°/36°/55°
Power factor :	Pf>0.5 / Pf>0.9
Power efficiency :	92%
Housing material :	Die-casting Aluminium
Optical material:	Reflective cup+Lens
Lighning protection :	1.5-4KV
Protection class :	Ip20



CDS211 SERIES

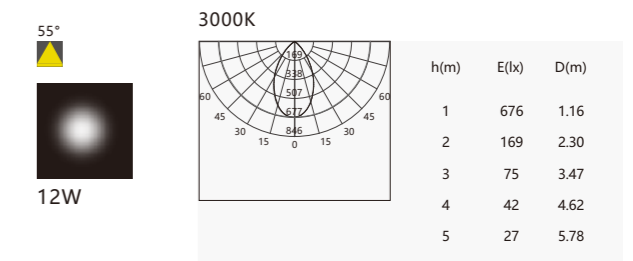
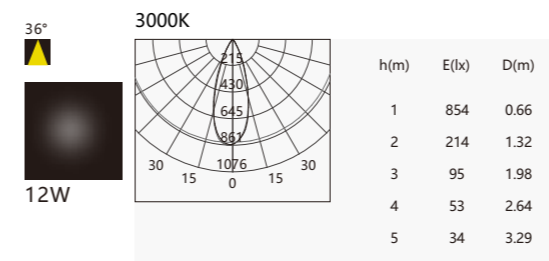
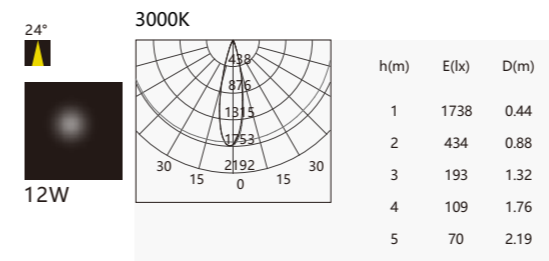
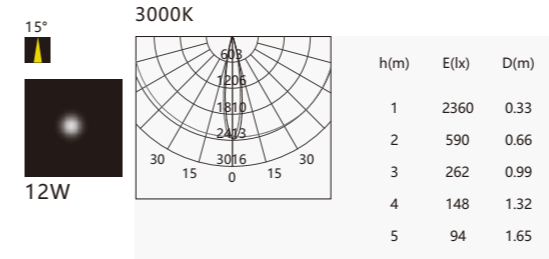
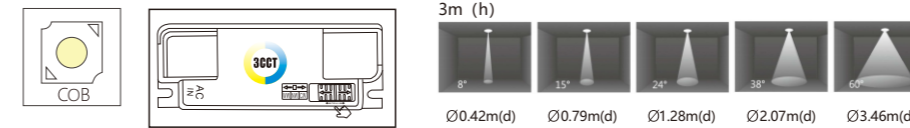

85-265V 50-60Hz	UGR≤6	LED	50000H Long Life
IP20	IP20	IP20	IP20
3000K Ra>80	4000K Ra>80	6500K Ra>80	
OSRAM	SAN AN	CREE	BRIDGELUX
	WH	BK	
	MATT WH	MATT BK	
	UV BK	UV SL	UV RSGD

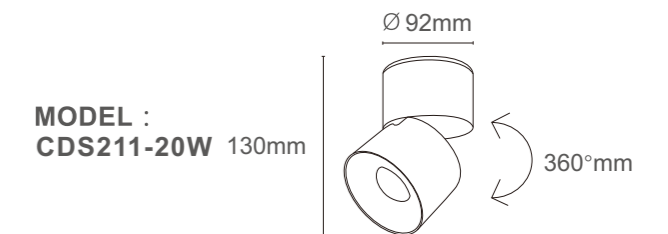
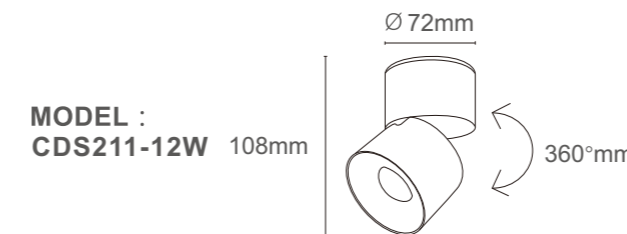

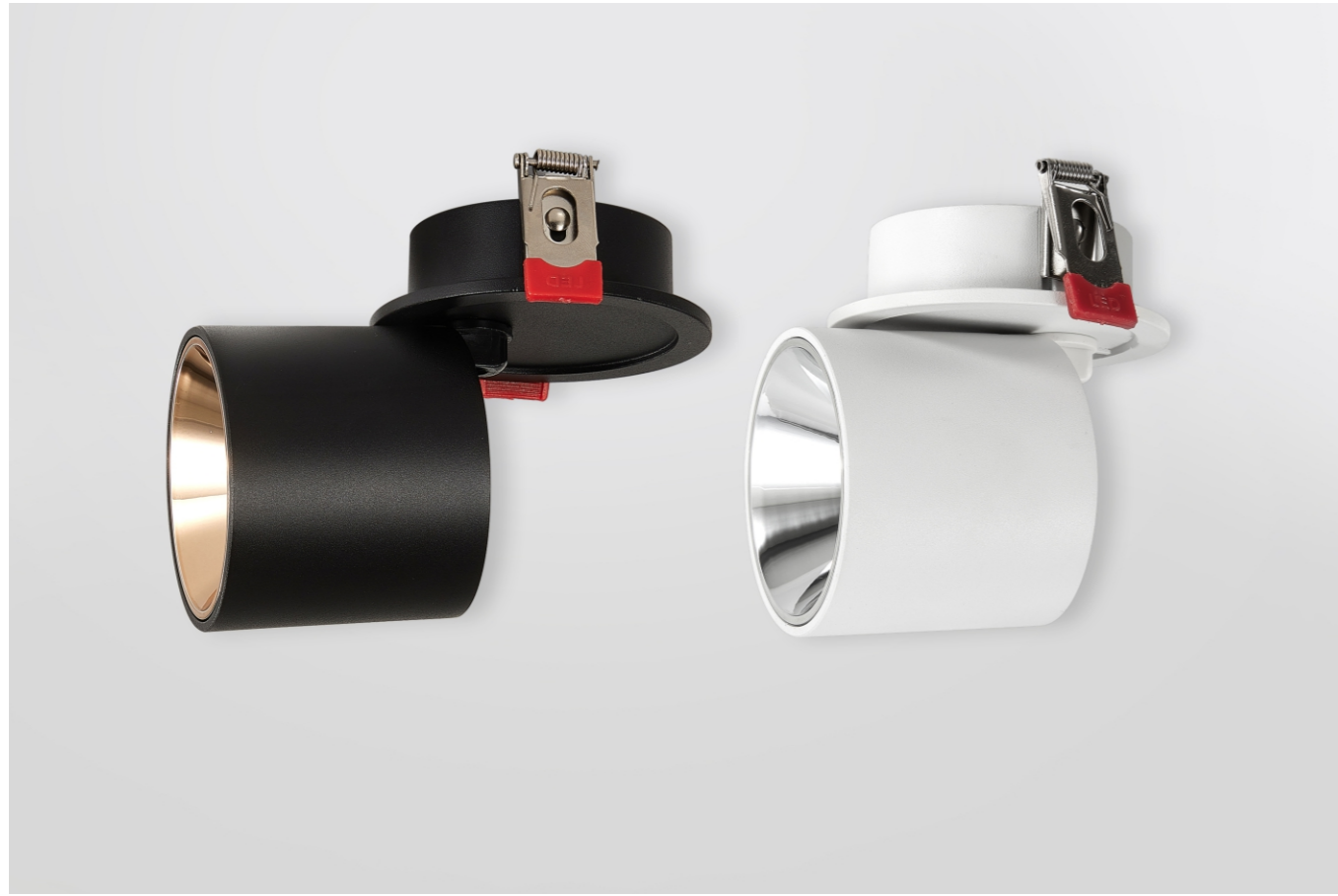

CDS212

TECHNICAL SPECIFICATIONS

Product Name :	COB Downlight
Model no:	CDS212
Power :	12W/20W
Input :	AC85-265V , 50 /60 HZ
Temperature range :	-20-50°C
Light source :	COB
Lumen :	80-110 LM/W
Colour Temperture :	3000K - 6500K/CCT
Colour Rendering Index :	CRI>80
Beam angle :	15°/24°/36°/60°
Power factor :	Pf>0.5 / Pf>0.9
Power efficiency :	92%
Housing material :	Die-casting Aluminium
Optical material:	Reflective cup+Lens
Lighning protection :	1.5-4KV
Protection class :	Ip20

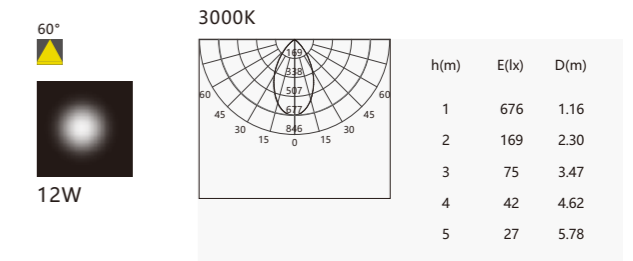
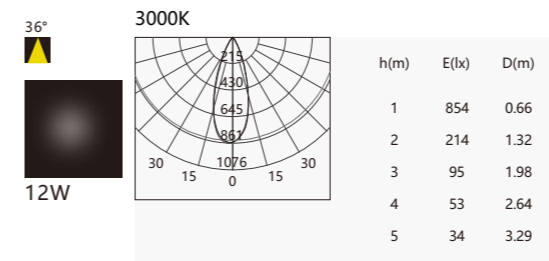
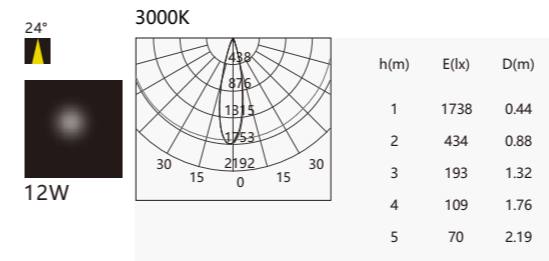
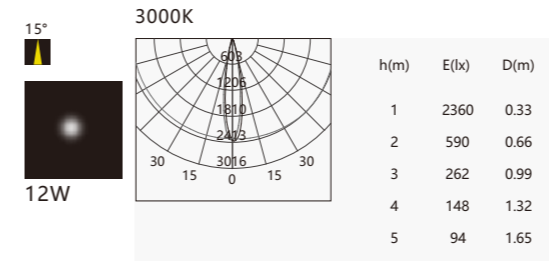
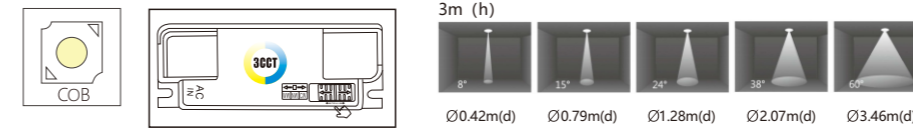

85-265V 50-60Hz	UGR≤6	LED	50000H Long Life
IP20	3000K Ra>80	4000K Ra>80	6500K Ra>80
OSRAM	SAN AN	CREE	BRIDGELUX
WH	BK	MATT WH	MATT BK
UV BK	UV SL	UV RSGD	

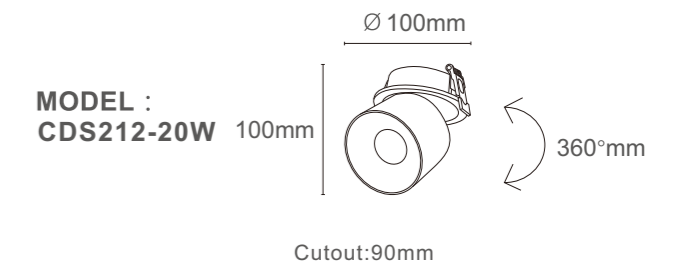
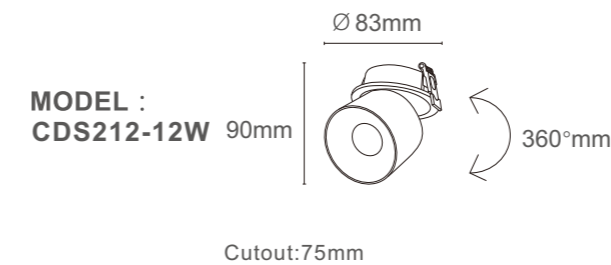



CDS213

TECHNICAL SPECIFICATIONS

Product Name :	COB Downlight
Model no:	CDS213
Power :	7W/15W/2*7W/2*15W
Input :	AC85-265V , 50 /60 HZ
Temperature range :	-20-50°C
Light source :	COB
Lumen :	80-110 LM/W
Colour Temperture :	3000K - 6500K/CCT
Colour Rendering Index :	CRI>80
Beam angle :	10°/15°/20°/24°/30°/36°/45°/60°
Power factor :	Pf>0.5 / Pf>0.9
Power efficiency :	92%
Housing material :	Die-casting Aluminium
Optical material:	Lens
Lighning protection :	1.5-4KV
Protection class :	Ip20



CDS213 SERIES

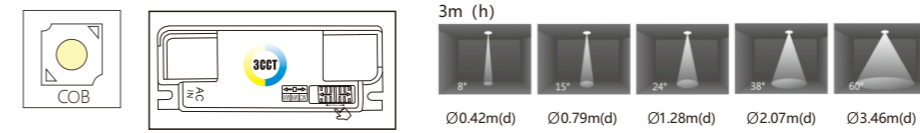

85-265V 50-60Hz	UGR≤6	LED	50000H Long Life
IP20	IP20	IP20	IP20
3000K Ra>80	4000K Ra>80	6500K Ra>80	
OSRAM	SAN AN	CREE	BRIDGELUX
	WH	BK	

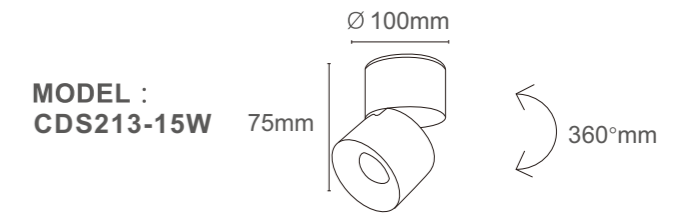
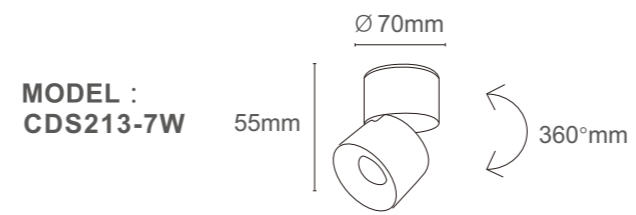
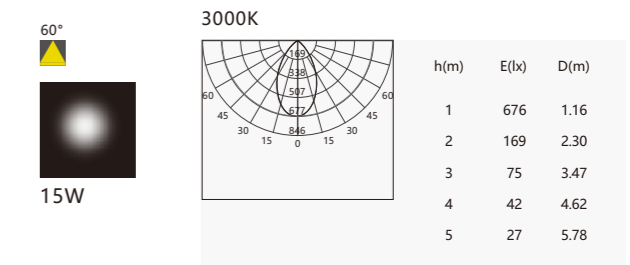
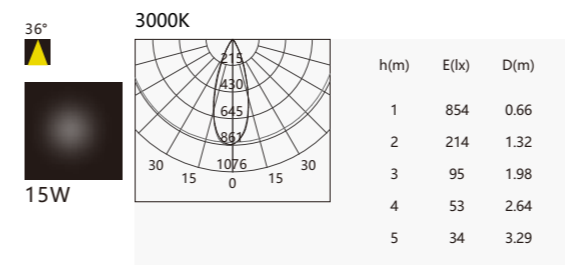
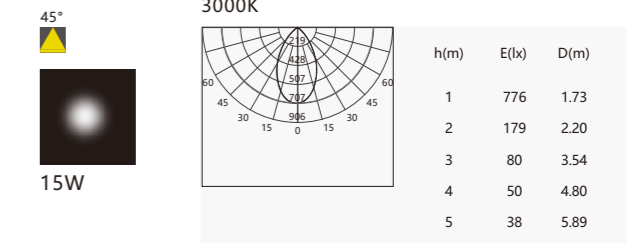
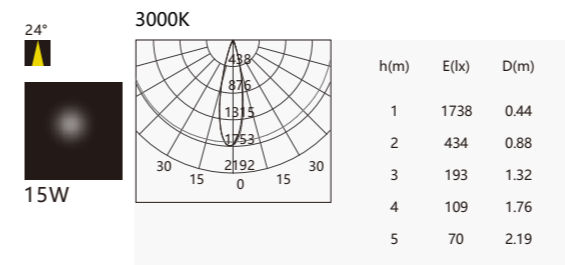
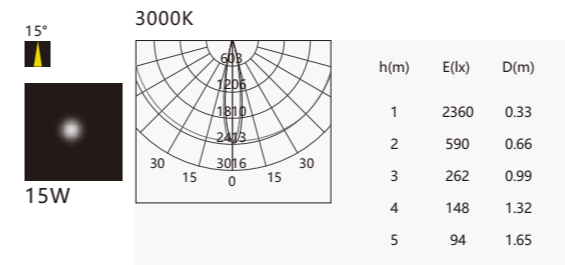



CDS214 SERIES

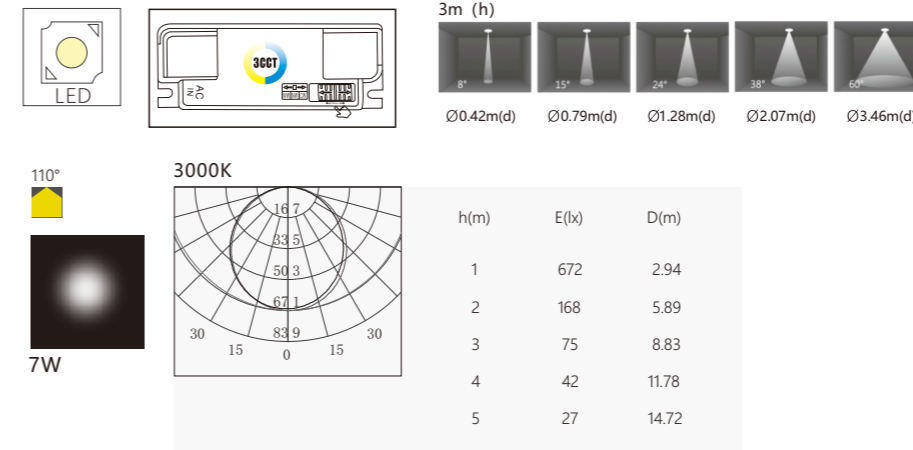

85-265V 50-60Hz	UGR≤6	LED	50000H Long Life
IP20	3000K Ra>80	4000K Ra>80	6500K Ra>80
OSRAM	SAN AN	CREE	BRIDGELUX
	WH	BK	

CDS214

TECHNICAL SPECIFICATIONS

Product Name :	SMD Downlight
Model no:	CDS214
Power :	7W/15W/2*7W/2*15W
Input :	AC85-265V , 50 /60 HZ
Temperature range :	-20-50°C
Light source :	SMD
Lumen :	80-110 LM/W
Colour Temperture :	3000K - 6500K/CCT
Colour Rendering Index :	CRI>80
Beam angle :	110°
Power factor :	Pf>0.5 / Pf>0.9
Power efficiency :	92%
Housing material :	Die-casting Aluminium
Cover material :	PC
Lighning protection :	1.5-4KV
Protection class :	Ip20

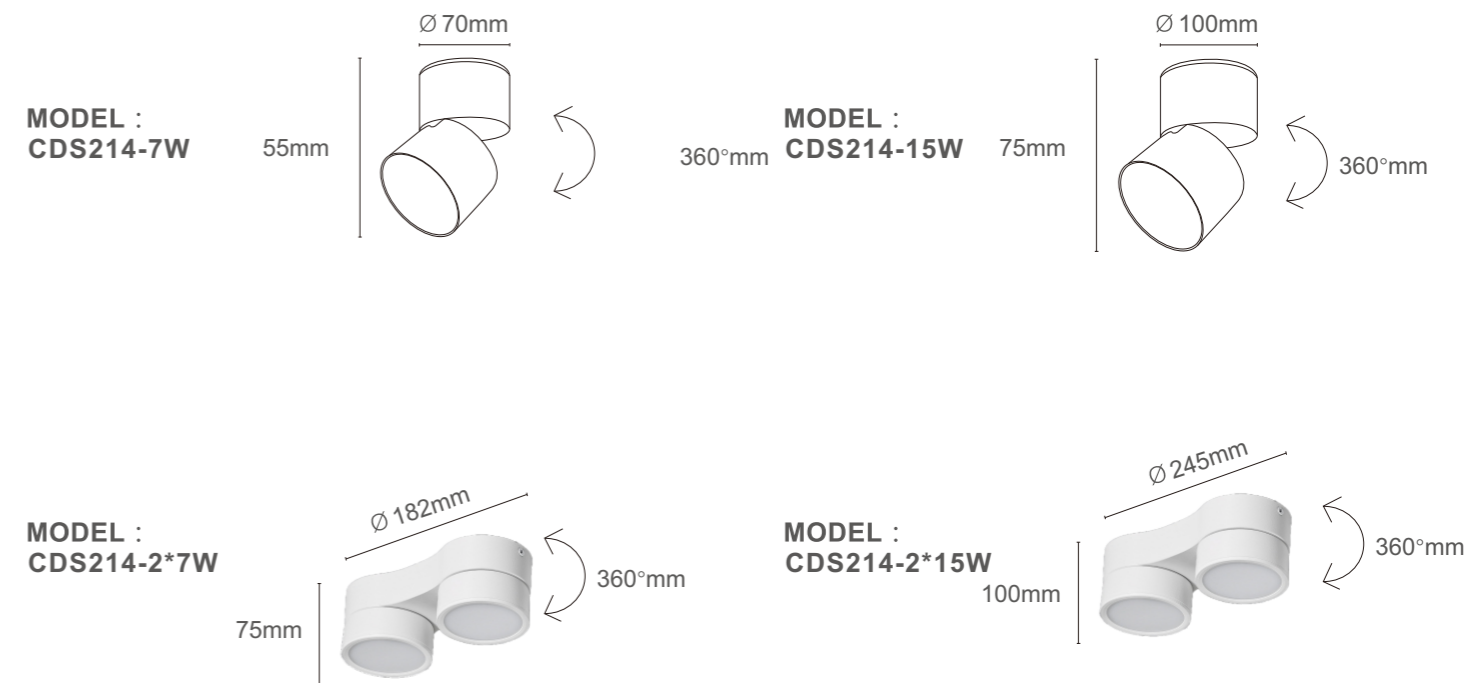



CDS215 SERIES

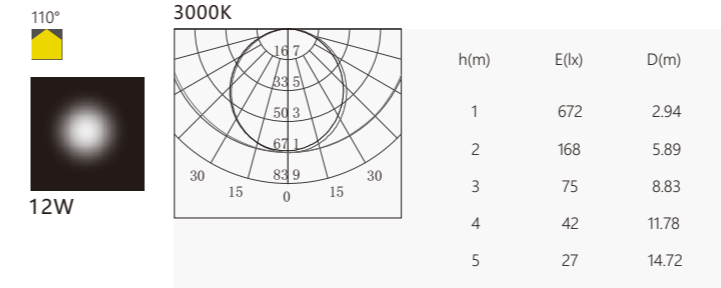
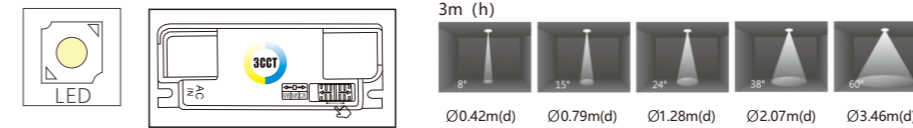

85-265V 50-60Hz	UGR≤6	LED	50000H Long Life
IP20	IP20	IP20	IP20
3 CCT	3000K Ra>80	4000K Ra>80	6500K Ra>80
OSRAM	SAN AN	CREE	BRIDGELUX
	WH	BK	

CDS215

TECHNICAL SPECIFICATIONS

Product Name :	SMD Downlight
Model no:	CDS215
Power :	12W
Input :	AC85-265V , 50 /60 HZ
Temperature range :	-20-50°C
Light source :	SMD
Lumen :	80-110 LM/W
Colour Temperture :	3000K - 6500K/CCT
Colour Rendering Index :	CRI>80
Beam angle :	110°
Power factor :	Pf>0.5 / Pf>0.9
Power efficiency :	92%
Housing material :	Die-casting Aluminium
Cover material :	PC
Lighning protection :	1.5-4KV
Protection class :	Ip20



MODEL :
CDS215-12W



Cutout:70mm



CDS216 SERIES

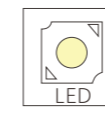

3m (h)

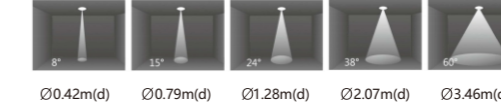

Ø0.42m(d) Ø0.79m(d) Ø1.28m(d) Ø2.07m(d) Ø3.46m(d)

110°



3000K

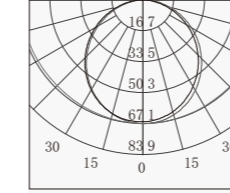

h(m)	E(lx)	D(m)
1	672	2.94
2	168	5.89
3	75	8.83
4	42	11.78
5	27	14.72

85-265V 50-60Hz	UGR≤6	LED	50000H Long Life
IP20	IP20	IP20	IP20
3 CCT	3000K Ra>80	4000K Ra>80	6500K Ra>80
OSRAM	SAN AN	CREE	BRIDGELUX
	WH	BK	

CDS216

TECHNICAL SPECIFICATIONS

Product Name :	SMD Downlight
Model no:	CDS216
Power :	12W
Input :	AC85-265V , 50 /60 HZ
Temperature range :	-20-50°C
Light source :	SMD
Lumen :	80-110 LM/W
Colour Temperture :	3000K - 6500K/CCT
Colour Rendering Index :	CRI>80
Beam angle :	110°
Power factor :	Pf>0.5 / Pf>0.9
Power efficiency :	92%
Housing material :	Die-casting Aluminium
Cover material :	PC
Lighning protection :	1.5-4KV
Protection class :	Ip20



MODEL :
CDS216-12W

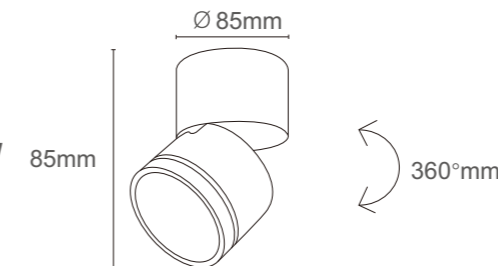



XG-CS102 SERIES

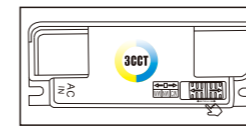
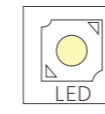

3m (h)

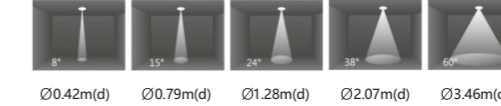

Ø0.42m(d) Ø0.79m(d) Ø1.28m(d) Ø2.07m(d) Ø3.46m(d)

110°



12W

3000K

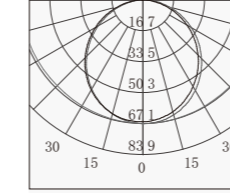

h(m)	E lx	D(m)
1	672	2.94
2	168	5.89
3	75	8.83
4	42	11.78
5	27	14.72

85-265V 50-60Hz	UGR≤6	LED	50000H Long Life
IP20	IP20	IP20	IP20
3 CCT	3000K Ra>80	4000K Ra>80	6500K Ra>80
OSRAM	SAN AN	CREE	BRIDGELUX
	WH	BK	

CDS217

TECHNICAL SPECIFICATIONS

Product Name :	COB Downlight
Model no:	CDS217
Power :	12W
Input :	AC85-265V , 50 /60 HZ
Temperature range :	-20-50°C
Light source :	COB
Lumen :	80-110 LM/W
Colour Temperture :	3000K - 6500K/CCT
Colour Rendering Index :	CRI>80
Beam angle :	15°/24°/36°
Power factor :	Pf>0.5 / Pf>0.9
Power efficiency :	92%
Housing material :	Die-casting Aluminium
Optical material:	Lens
Lighning protection :	1.5-4KV
Protection class :	Ip20



MODEL :
CDS217-12W

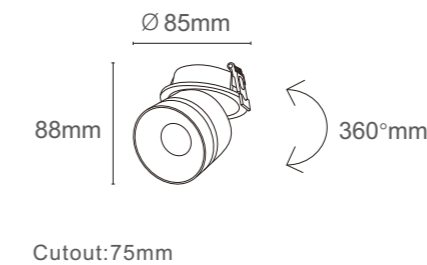

Cutout:75mm



CDS218

TECHNICAL SPECIFICATIONS

Product Name :	COB Downlight
Model no:	CDS218
Power :	12W
Input :	AC85-265V , 50 /60 HZ
Temperature range :	-20-50°C
Light source :	COB
Lumen :	80-110 LM/W
Colour Temperture :	3000K - 6500K/CCT
Colour Rendering Index :	CRI>80
Beam angle :	15°/24°/36°
Power factor :	Pf>0.5 / Pf>0.9
Power efficiency :	92%
Housing material :	Die-casting Aluminium
Optical material:	Reflective cup+Lens
Lighning protection :	1.5-4KV
Protection class :	Ip20



CDS218 SERIES

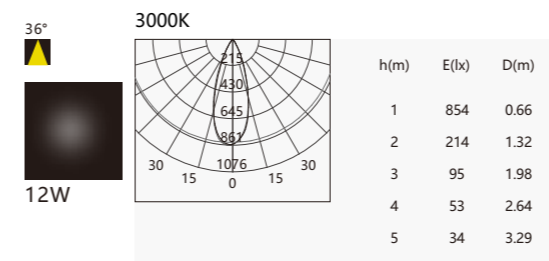
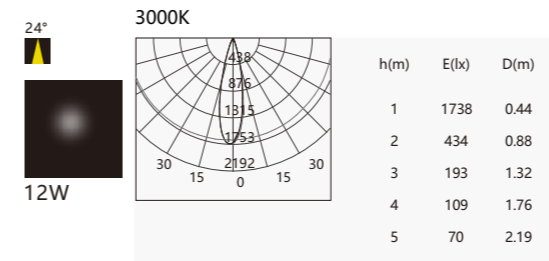
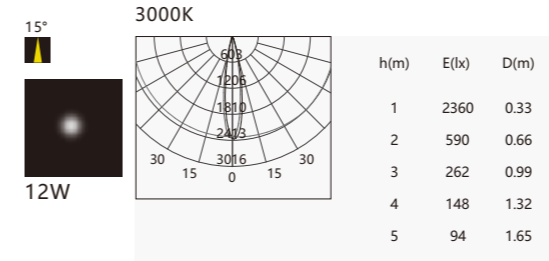
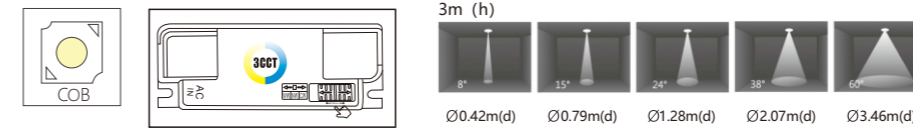

85-265V 50-60Hz	UGR≤6	LED	50000H Long Life
IP20	IP20	IP20	IP20
3CCT	3000K Ra>80	4000K Ra>80	6500K Ra>80
OSRAM	SAN AN	CREE	BRIDGELUX
	WH	BK	
	MATT WH	MATT BK	
	UV SL	UV RSGD	

MODEL :
CDS218-12W

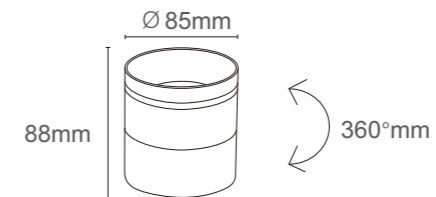



CDS219

TECHNICAL SPECIFICATIONS

Product Name :	COB Downlight
Model no:	CDS219
Power :	15W
Input :	AC85-265V , 50 /60 HZ
Temperature range :	-20-50°C
Light source :	COB
Lumen :	80-110 LM/W
Colour Temperture :	3000K - 6500K/CCT
Colour Rendering Index :	CRI>80
Beam angle :	15°/24°/36°
Power factor :	Pf>0.5 / Pf>0.9
Power efficiency :	92%
Housing material :	Die-casting Aluminium
Optical material:	Reflective cup
Lighning protection :	1.5-4KV
Protection class :	Ip20



CDS219 SERIES

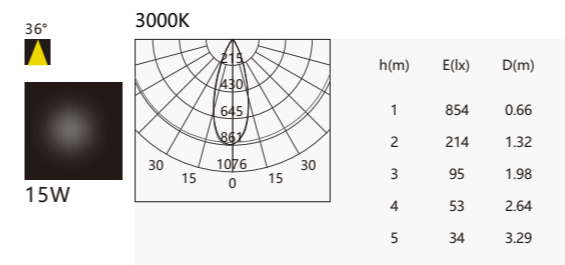
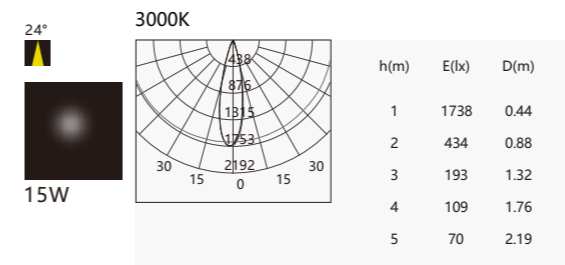
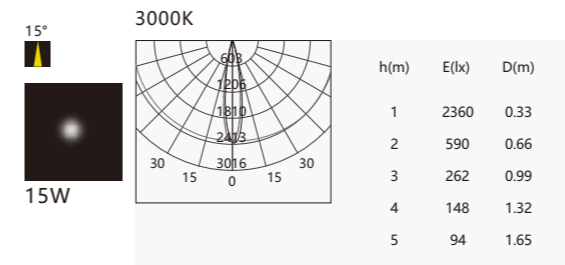
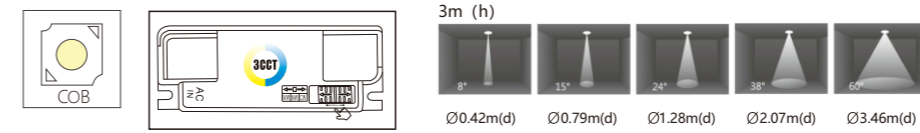

85-265V 50-60Hz	UGR≤6	LED	50000H Long Life
IP20	3000K Ra>80	4000K Ra>80	6500K Ra>80
OSRAM	SAN AN	CREE	BRIDGELUX
	WH	BK	
MATT WH	MATT BK	MATT GD	

MODEL :
CDS219-15W

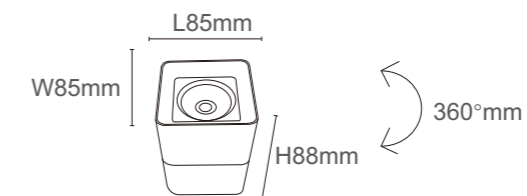



CDS220

CDS221

TECHNICAL SPECIFICATIONS

Product Name :	COB Downlight
Model no:	CDS220/CDS221
Power :	12W
Input :	AC85-265V , 50 /60 HZ
Temperature range :	-20-50°C
Light source :	COB
Lumen :	80-110 LM/W
Colour Temperture :	3000K - 6500K/CCT
Colour Rendering Index :	CRI>80
Beam angle :	15°/24°/36°/55°
Power factor :	Pf>0.5 / Pf>0.9
Power efficiency :	92%
Housing material :	Die-casting Aluminium
Optical material:	Reflective cup+Lens
Lighning protection :	1.5-4KV
Protection class :	Ip20

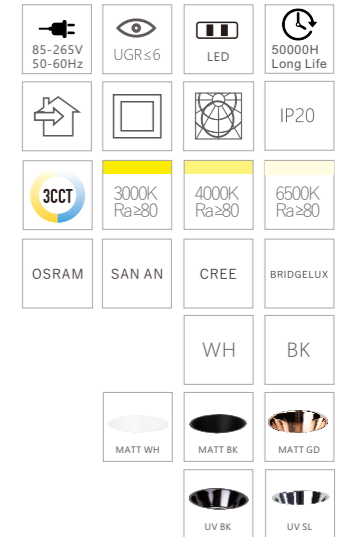
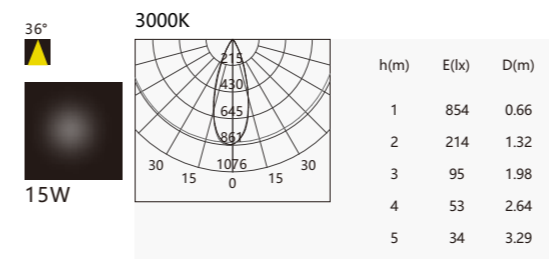
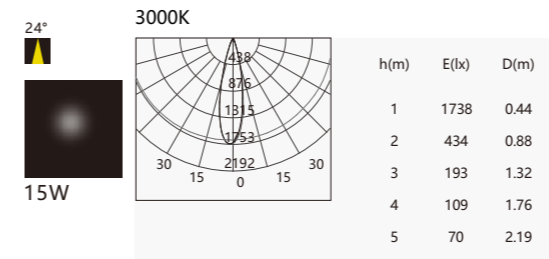
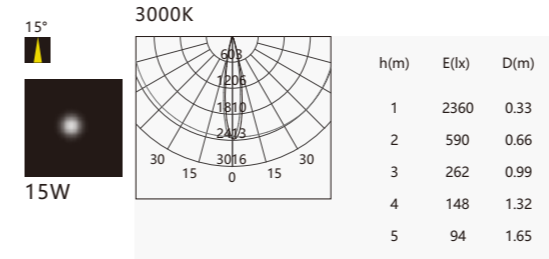
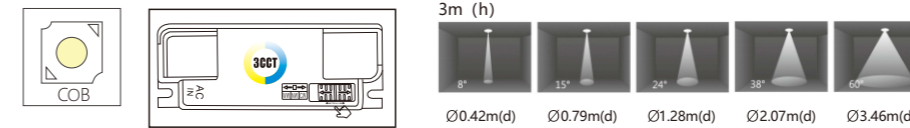

MODEL :
CDS220-12W

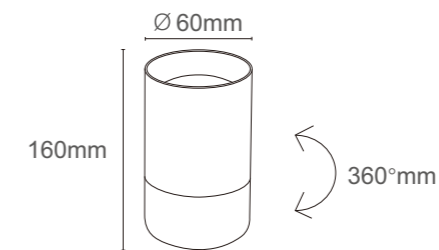

MODEL :
CDS221-12W

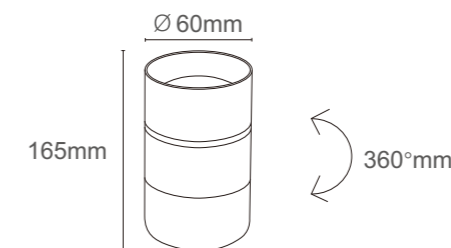



CDS222

TECHNICAL SPECIFICATIONS

Product Name :	COB Downlight
Model no:	CDS222
Power :	7W/2*7W/4*7W
Input :	AC85-265V , 50 /60 HZ
Temperature range :	-20-50°C
Light source :	COB
Lumen :	80-110 LM/W
Colour Temperture :	3000K - 6500K/CCT
Colour Rendering Index :	CRI>80
Beam angle :	15°/24°/36°
Power factor :	Pf>0.5 / Pf>0.9
Power efficiency :	92%
Housing material :	Die-casting Aluminium
Optical material:	Reflective cup+Lens
Lighning protection :	1.5-4KV
Protection class :	Ip20



XG-CS102 SERIES

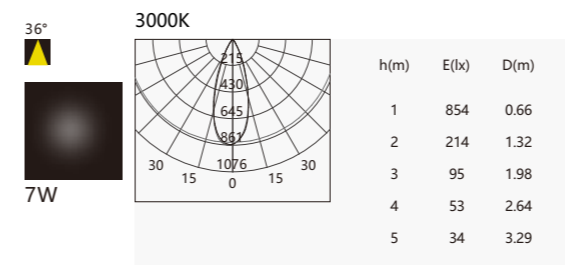
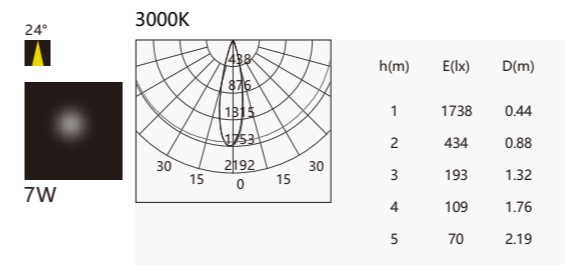
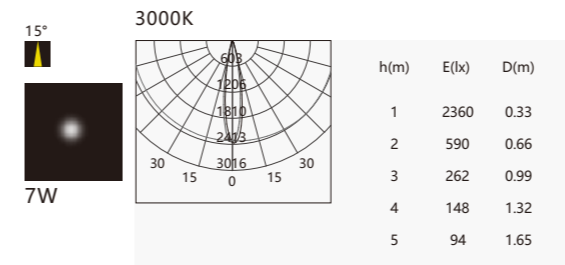
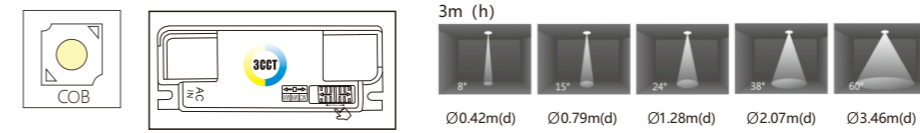

85-265V 50-60HZ	UGR≤6	LED	50000H Long Life
IP20	IP20	IP20	IP20
3000K Ra>80	4000K Ra>80	6500K Ra>80	
OSRAM	SAN AN	CREE	BRIDGELUX
	WH	BK	
MATT WH	MATT BK	MATT SL	
UV BK	UV SL	UV GD	

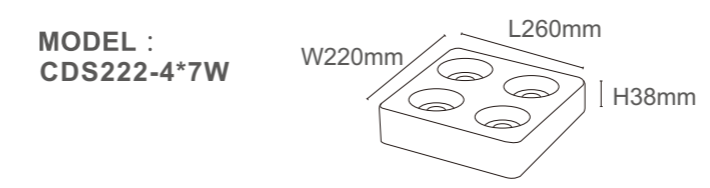
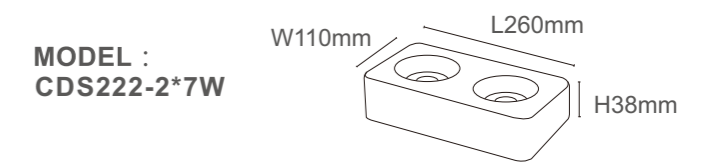
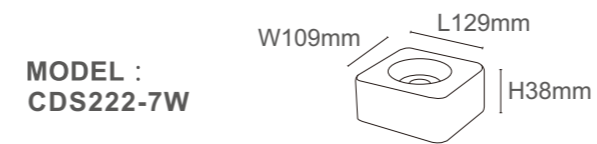



CDS224

TECHNICAL SPECIFICATIONS

Product Name :	COB Downlight
Model no:	CDS224
Power :	20W/30W/40W
Input :	AC85-265V , 50 /60 HZ
Temperature range :	-20-50°C
Light source :	COB
Lumen :	80-110 LM/W
Colour Temperture :	3000K - 6500K/CCT
Colour Rendering Index :	CRI>80
Beam angle :	15°/24°/36°
Power factor :	Pf>0.5 / Pf>0.9
Power efficiency :	92%
Housing material :	Die-casting Aluminium
Optical material:	Reflective cup+Lens
Lighning protection :	1.5-4KV
Protection class :	Ip20



XG-CS102 SERIES

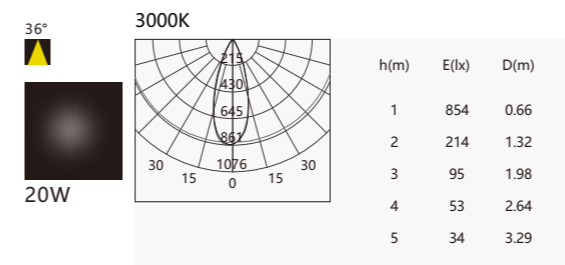
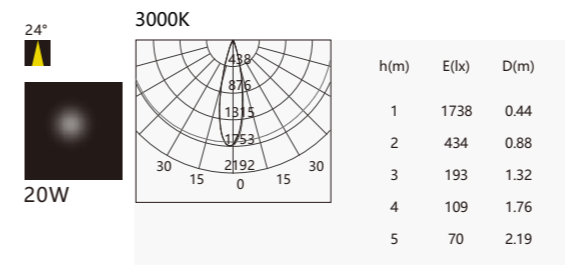
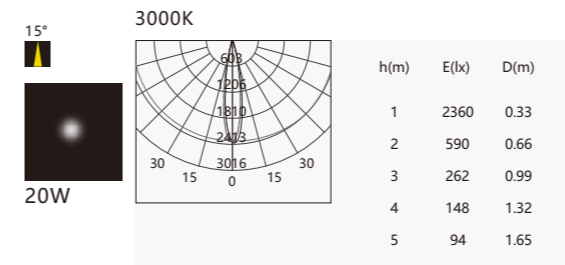
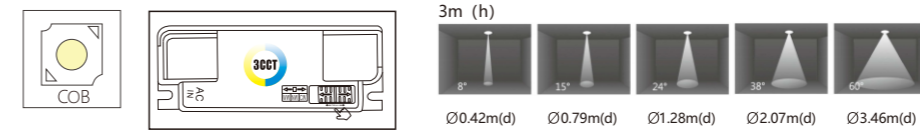

85-265V 50-60Hz	UGR≤6	LED	50000H Long Life
IP20	3000K Ra>80	4000K Ra>80	6500K Ra>80
OSRAM	SAN AN	CREE	BRIDGELUX
	WH	BK	
SAND WH	SAND BK	MATT BK	MATT SL
UV BK	UV SL	UV GD	UVSRGD

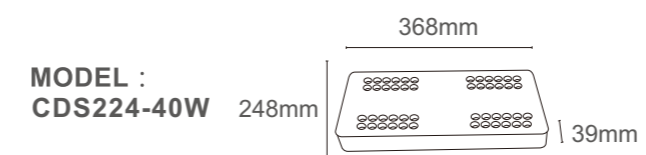
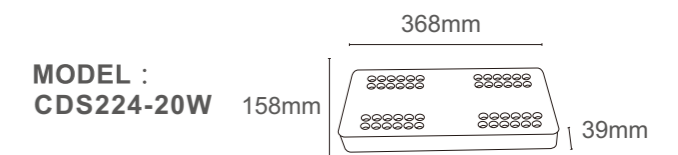
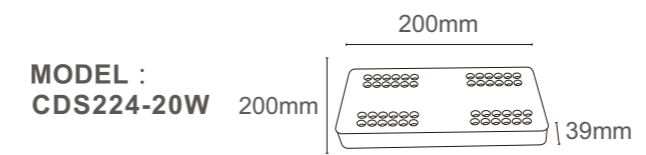



CD-6501

TECHNICAL SPECIFICATIONS

Product Name :	COB Downlight
Model no:	CD-6501
Power :	10W/15W
Input :	AC85-265V , 50 /60 HZ
Temperature range :	-20-50°C
Light source :	COB
Lumen :	80-110 LM/W
Colour Temperture :	3000K - 6500K/CCT
Colour Rendering Index :	CRI>80
Beam angle :	24°/36°/60°
Power factor :	Pf>0.5 / Pf>0.9
Power efficiency :	92%
Housing material :	Die-casting Aluminium
Optical material:	Reflective cup+Lens
Lighning protection :	1.5-4KV
Protection class :	Ip65

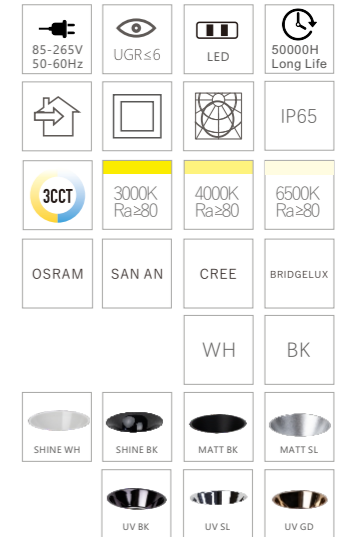
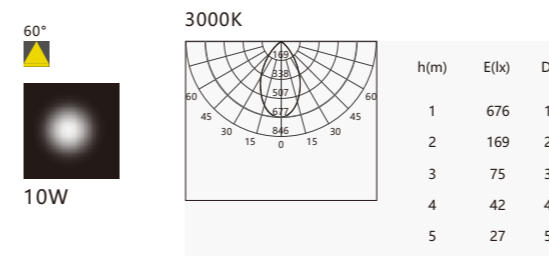
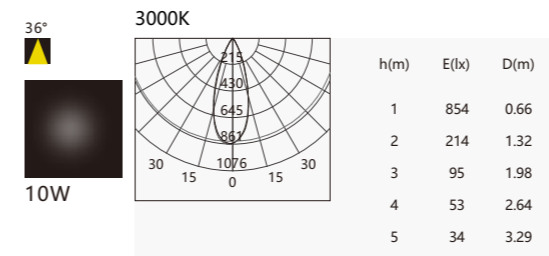
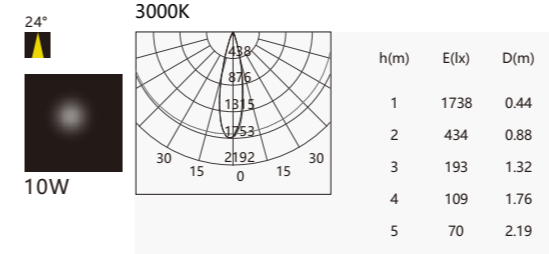
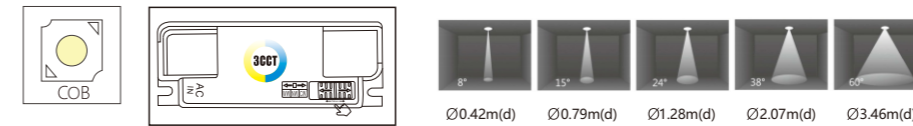

MODEL :
CD-6501-10W

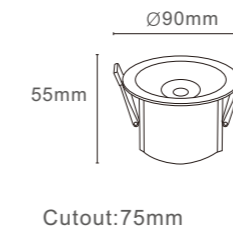

MODEL :
CD-6501-15W

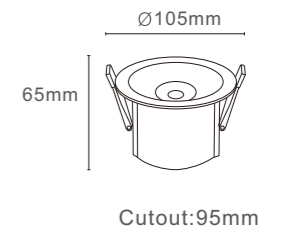



IP65

CD-6502

TECHNICAL SPECIFICATIONS

Product Name :	COB Downlight
Model no:	CD-6502
Power :	12W/18W/30W
Input :	AC85-265V , 50 /60 HZ
Temperature range :	-20-50°C
Light source :	COB
Lumen :	80-110 LM/W
Colour Temperture :	3000K - 6500K/CCT
Colour Rendering Index :	CRI>80
Beam angle :	20°/40°
Power factor :	Pf>0.5 / Pf>0.9
Power efficiency :	92%
Housing material :	Die-casting Aluminium
Optical material:	Reflective cup+Lens
Lighning protection :	1.5-4KV
Protection class :	Ip65



CD-6502 SERIES

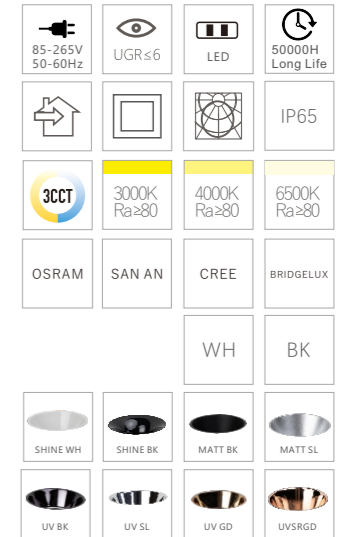
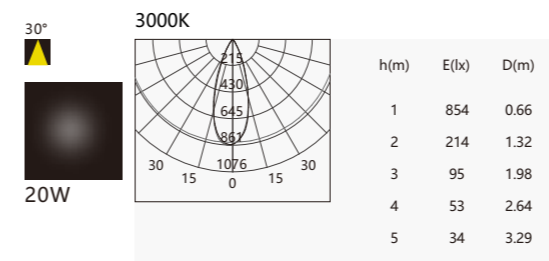
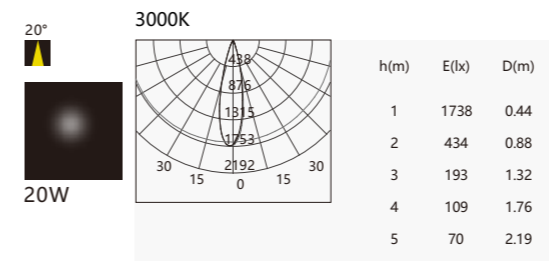
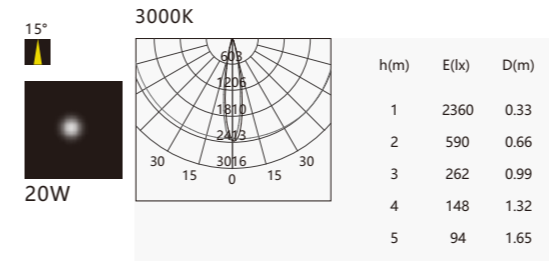

MODEL :
CD-6502-12W

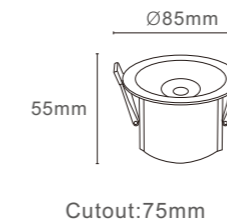

MODEL :
CD-6501-18W

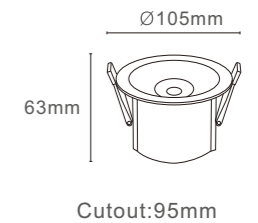

MODEL :
CD-6502-30W

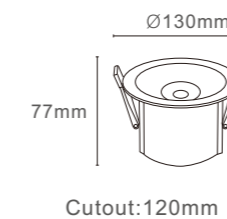



CD-6503

TECHNICAL SPECIFICATIONS

Product Name :	COB Downlight
Model no:	CD-6503
Power :	15W/20W/30W/40W/50W
Input :	AC85-265V , 50 /60 HZ
Temperature range :	-20-50°C
Light source :	COB
Lumen :	80-110 LM/W
Colour Temperture :	3000K - 6500K/CCT
Colour Rendering Index :	CRI>80
Beam angle :	24°/30°/40°
Power factor :	Pf>0.5 / Pf>0.9
Power efficiency :	92%
Housing material :	Die-casting Aluminium
Optical material:	Reflective cup
Lighning protection :	1.5-4KV
Protection class :	Ip65

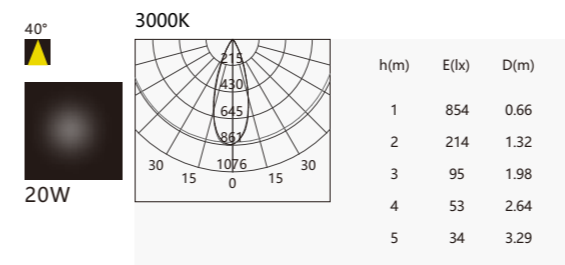
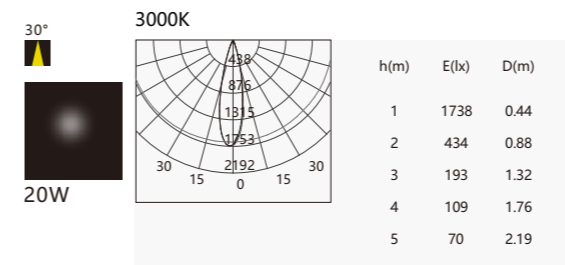
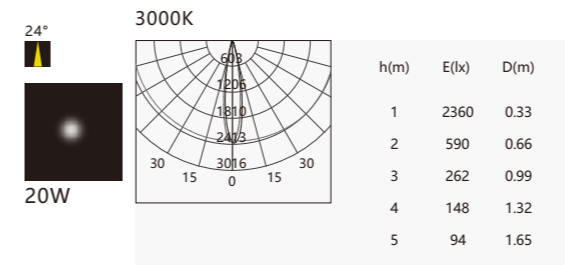

85-265V 50-60Hz	UGR≤6	LED	50000H Long Life
IP65	3000K Ra>80	4000K Ra>80	6500K Ra>80
OSRAM	SAN AN	CREE	BRIDGELUX
	WH	BK	

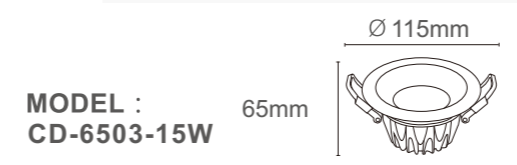

Cutout:95mm

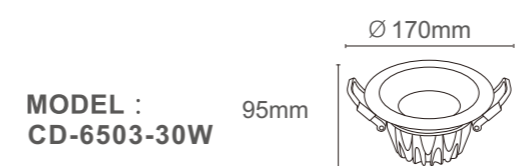

Cutout:150mm



Cutout:200mm

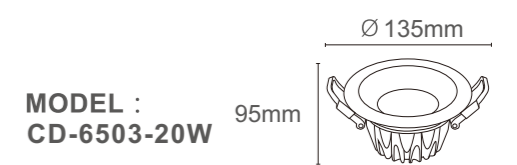

Cutout:120mm

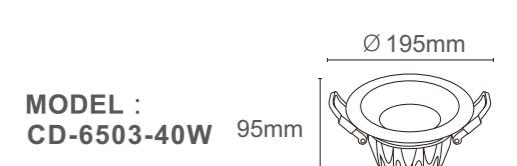

Cutout:170mm