

GET THE LATEST
aluminum profiles and hardware for any project,
with our superior stock and R&D capabilities.

86-13066442560



web



wechat



whatsapp

Foshan Waybom Technology Co.,Ltd

Office Address: Room 1606, Weiye International Building,
No.75 Lingnan Road, Nanhai, Foshan, Guangdong, China

Show Room Address: Northeast of Ligang Industrial Zone, Nanhai, Foshan,
Guangdong (next to Yirui) Waybom Aluminum



WAYBOM ALUMINUM



WAYBOM

MINIMALIST LIGHT LUXURY CUSTOM MATCHING

Get the latest

*aluminum profiles
and hardware for any project,
with our superior stock and R&D capabilities.*

THE DESIGN
IS IMPECCABLE



ENTERPRISE

BRIEF INTRODUCTION

Established in 2008, we are a first-line factory with powder coating lines, anodizing lines and ten extrusion lines of different aluminium bar diameters, with an annual production capacity of over 30,000 tonnes.

Our main products are aluminium profiles, including aluminium profiles for interior doors, aluminium cabinet doors and handles, and glass cabinet profiles.

During the last decade of development and growth, Waybom aluminium has always adhered to the entrepreneurial spirit of focus and professionalism and will continue to provide quality products and professional services to our customers. Currently Waybom aluminium has developed foreign business in more than ten countries and regions such as Saudi Arabia, South East Asia and Africa.

CATALOGUE

1. GLASS CABINET SERIES ALUMINUM PROFILES

① New aluminum wood cabinet aluminum profiles	P 01
② Glass wine cabinet aluminum profile	P 05
③ Glass wardrobe aluminum profile	P 07
④ Schematic diagram of glass cabinet assembly	P 09
⑤ Column wardrobe aluminum profiles	P 11
⑥ Column cabinets aluminum profiles	P 13
⑦ Walk-in cloakroom aluminum profiles	P 15
⑧ Kitchen shelf aluminum profiles	P 17

2. DOOR PANEL SERIES ALUMINUM PROFILES

① 20 hinge series aluminum profiles	P 19
② 35 hinge series aluminum profiles	P 27
③ Air hinge series aluminum profile	P 39
④ Soft close pivot hinge series aluminum profile	P 47
⑤ Door panel profile DWG sketch	P 53

3. WARDROBE SLIDING DOOR SERIES ALUMINUM PROFILES

Wardrobe sliding door A/B type physical map and profile accessories map	P 61
Wardrobe sliding door profile drawing of type C, assembly drawing and dwg drawings of wardrobe sliding door profiles A, B, and C	P 65
Folding door profile cad drawing of wardrobe 20 door panels	P 67

4. LAMINATE SERIES

18mm, 22mm, 25mm, 36mm glass laminate	P 69
---------------------------------------	------

5. ECOLOGICAL DOOR SYSTEM

Ecological door 45 series	P 77
Ecological door 50 series	P 79

6. HANDLE PROFILE

Milling edge banding handle series	P 83
G type, L type handle profile DWG	P 93
L-shaped mother and child, slot-free edge banding handle DWG	P 95

7. DINING TABLE PROFILE

Round corner profile	P 97
Right-angle, diamond-shaped profiles	P 100

8. SHELF SERIES

L-shaped shelf profile	P 101
Internet celebrity racks, wall cabinet profiles	P 105

9. MINIMALIST ACCESSORIES

Aluminum, hinge, aluminum corner	P 107
----------------------------------	-------

新款铝木柜 NEW ALUMINUM WOOD CABINET ALUMINUM PROFILE



新款铝木柜 DWG图纸 NEW ALUMINUM WOODEN CABINET DWG DRAWINGS

<p>LMG-2001</p> <p>KG/M: 0.672kg/m</p>	<p>LMG-2002</p> <p>KG/M: 0.659kg/m</p>	<p>LMG-2003</p> <p>KG/M: 0.70kg/m</p>	<p>LMG-2004</p> <p>KG/M: 0.362kg/m</p>
<p>LMG-2005</p> <p>KG/M: 0.3kg/m</p>	<p>LMG-2006</p> <p>KG/M: 0.099kg/m</p>	<p>LMG-2007</p> <p>KG/M: 0.855kg/m</p>	<p>LMG-2008</p> <p>KG/M: 1.14kg/m</p>
<p>LMG-2009</p> <p>KG/M: 1.481kg/m</p>	<p>LMG-2010</p> <p>KG/M: 1.06kg/m</p>	<p>LMG-2011</p> <p>KG/M: 1.45kg/m</p>	<p>LMG-2012</p> <p>KG/M: 1.23kg/m</p>



新款铝木柜(平开门款) NEW ALUMINUM WOOD CABINET ALUMINUM PROFILE (SWING DOOR STYLE)

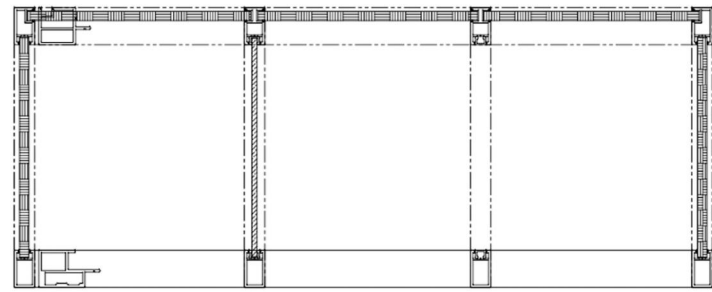

俯视 (top view)

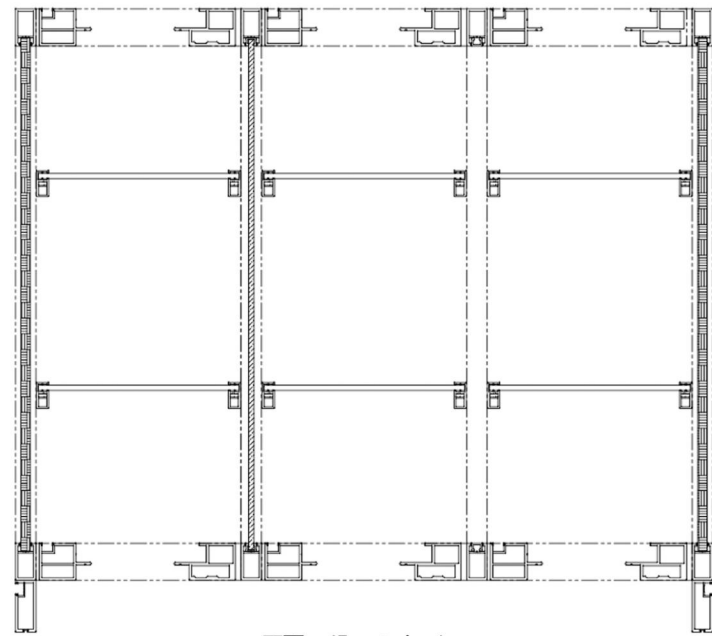

正面 (Front view)

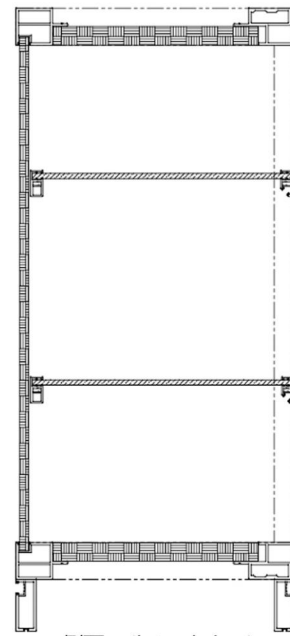

侧面 (lateral view)

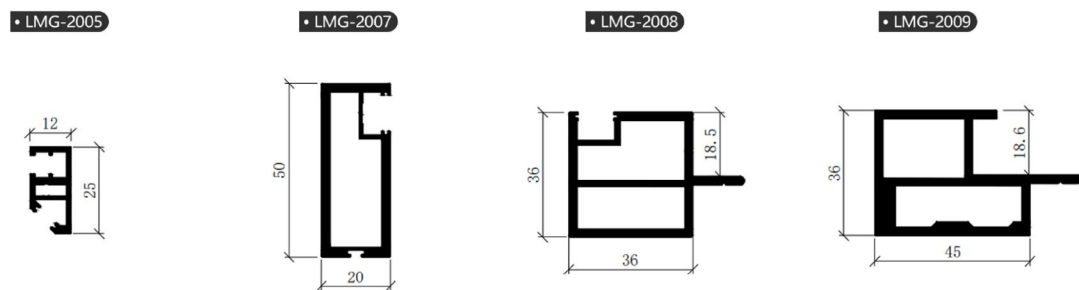
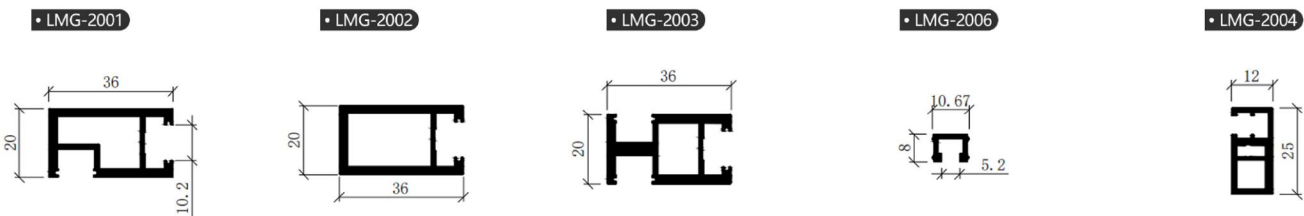

新款铝木柜(推拉门款) NEW ALUMINUM WOOD CABINET ALUMINUM PROFILE (SLIDING DOOR STYLE)

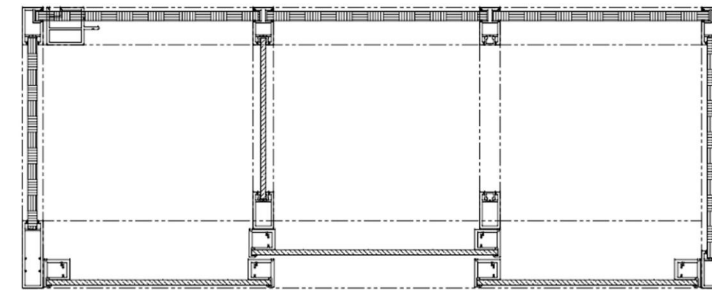

俯视 (top view)

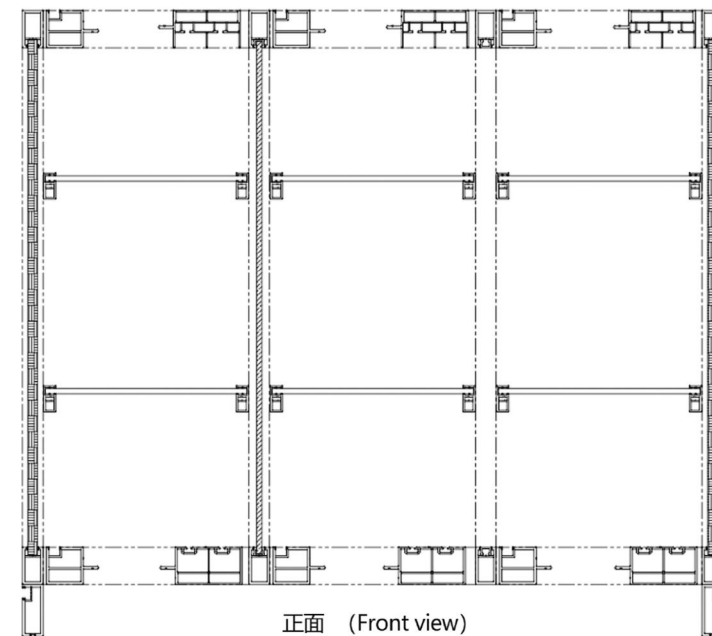

正面 (Front view)

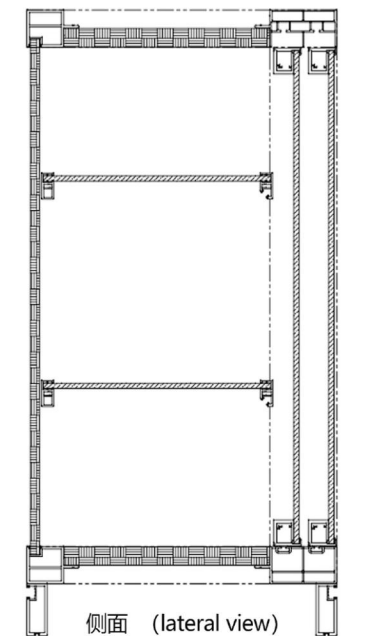

侧面 (lateral view)

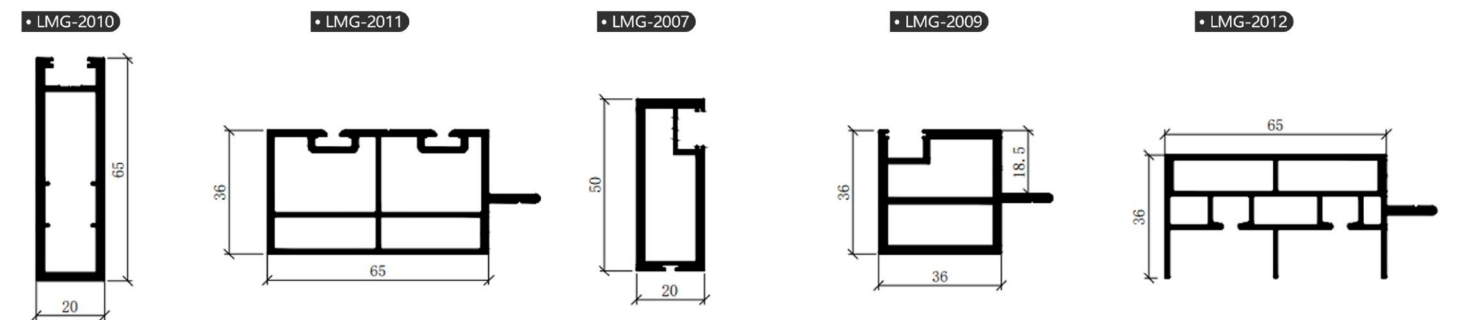
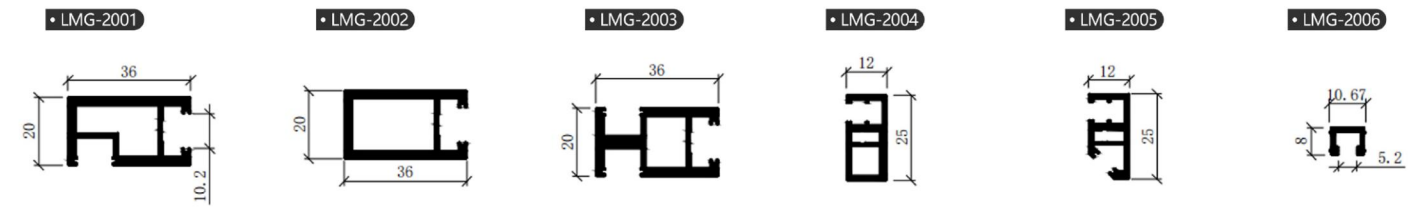

玻璃酒柜 GLASS WINE CABINET ALUMINUM PROFILE

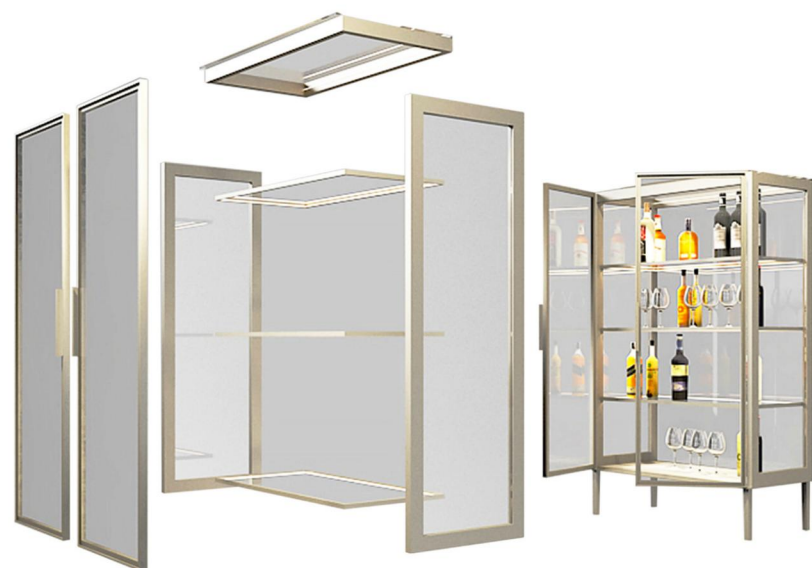

玻璃酒柜DWG图纸 GLASS WINE CABINET DWG DRAWING

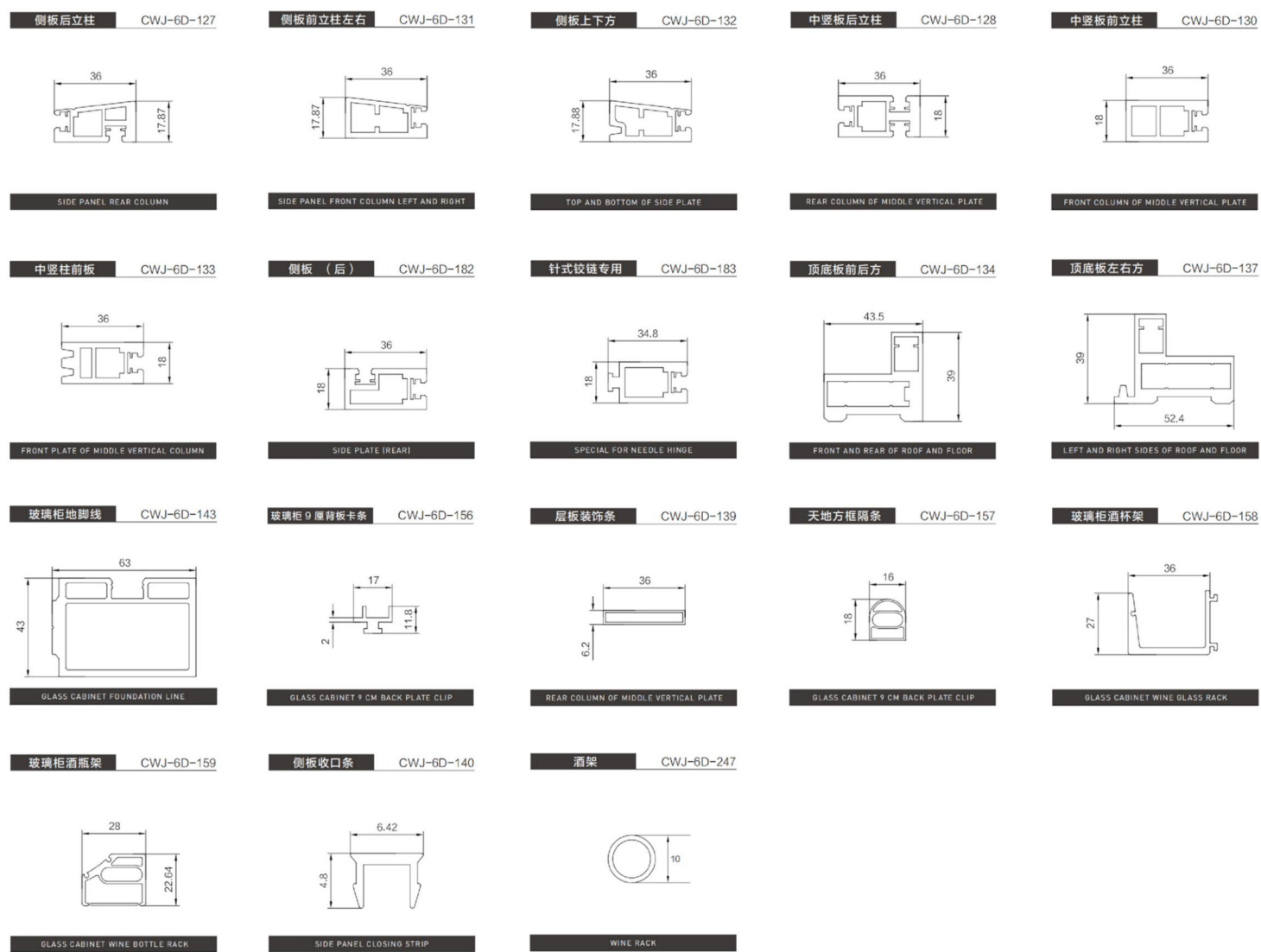

玻璃衣柜 GLASS WARDROBE ALUMINUM PROFILE

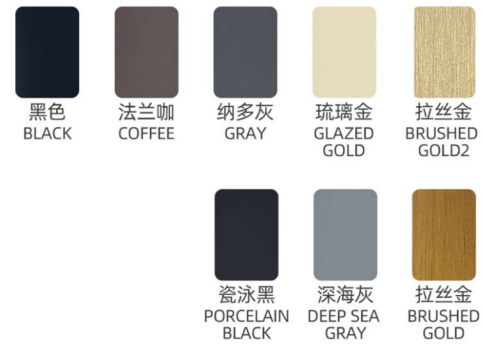

玻璃衣柜DWG图纸 GLASS WARDROBE DWG DRAWINGS

<p>侧板后立柱 CWJ-6D-127</p> <p>SIDE PANEL REAR COLUMN</p>	<p>侧板前立柱左右 CWJ-6D-131</p> <p>SIDE PANEL FRONT COLUMN LEFT AND RIGHT</p>	<p>侧板上下方 CWJ-6D-132</p> <p>TOP AND BOTTOM OF SIDE PLATE</p>	<p>中竖板前立柱 CWJ-6D-130</p> <p>FRONT COLUMN OF MIDDLE VERTICAL PLATE</p>	<p>中竖柱前板 CWJ-6D-133</p> <p>FRONT PLATE OF MIDDLE VERTICAL COLUMN</p>
<p>中竖板后立柱 CWJ-6D-128</p> <p>REAR COLUMN OF MIDDLE VERTICAL PLATE</p>	<p>侧板(后) CWJ-6D-182</p> <p>SIDE PLATE (REAR)</p>	<p>针式铰链专用 CWJ-6D-183</p> <p>SPECIAL FOR NEEDLE HINGE</p>	<p>中竖板横拉方 CWJ-6D-129</p> <p>HORIZONTAL PULLING SQUARE OF MIDDLE VERTICAL PLATE</p>	<p>顶底板前后方 CWJ-6D-134</p> <p>FRONT AND REAR OF ROOF AND FLOOR</p>
<p>顶底板左右方 CWJ-6D-137</p> <p>LEFT AND RIGHT SIDES OF ROOF AND FLOOR</p>	<p>玻璃柜地脚线 CWJ-6D-143</p> <p>GLASS CABINET FOUNDATION LINE</p>	<p>玻璃柜9厘背板卡条 CWJ-6D-156</p> <p>GLASS CABINET 9 CM BACK PLATE CLIP</p>	<p>18 板背板配件 CWJ-6D-138</p> <p>18 BOARD BACK PLATE ACCESSORIES</p>	<p>侧板收口条 CWJ-6D-140</p> <p>SIDE PANEL CLOSING STRIP</p>
<p>衣通管 CWJ-6D-209</p> <p>YITONG PIPE</p>	<p>玻璃柜5MM背板分隔条 CWJ-6D-175</p> <p>5MM BACK PLATE PARTITION STRIP OF GLASS CABINET</p>	<p>衣通管(可带灯带) CWJ-6D-176</p> <p>YITONG PIPE (WITH LIGHT BAND)</p>		



玻璃柜体组装示意图

GLASS DOOR PANEL ASSEMBLY DIAGRAM

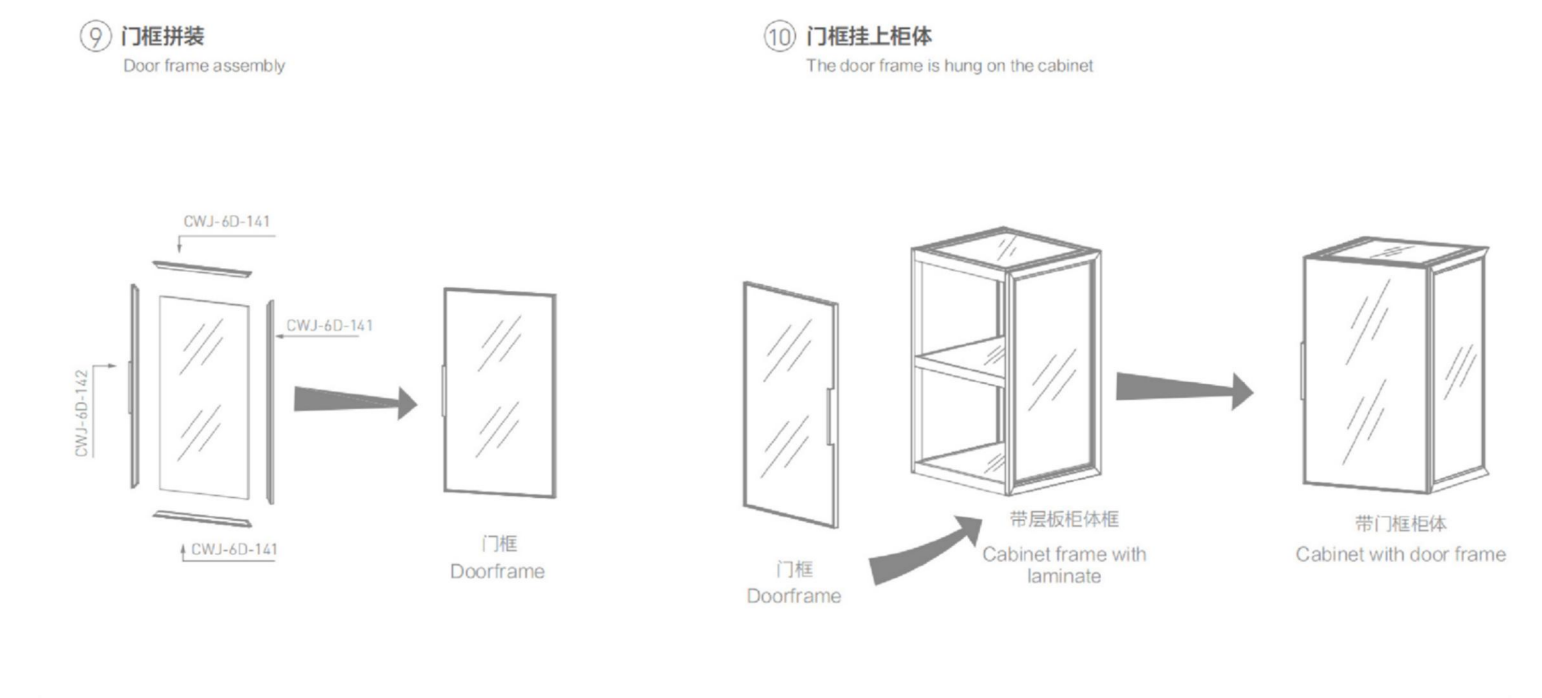
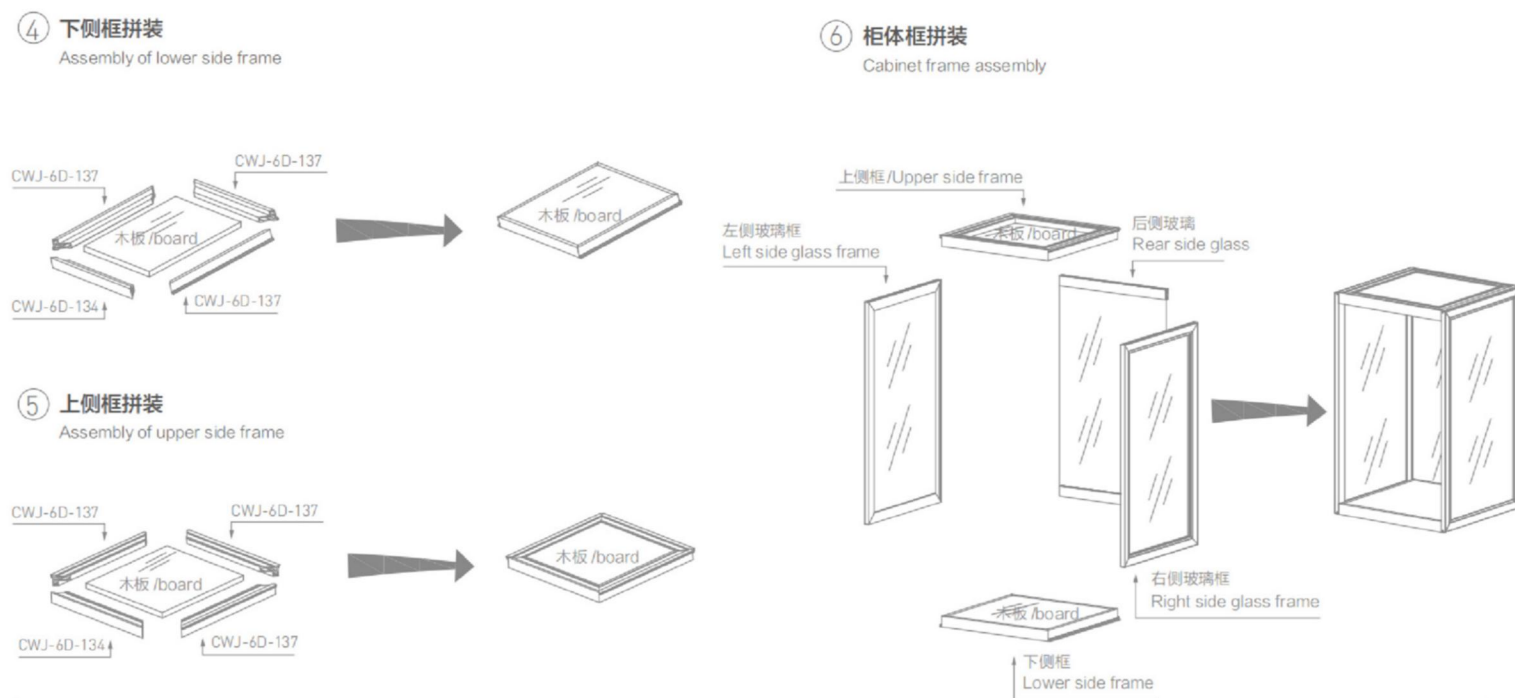
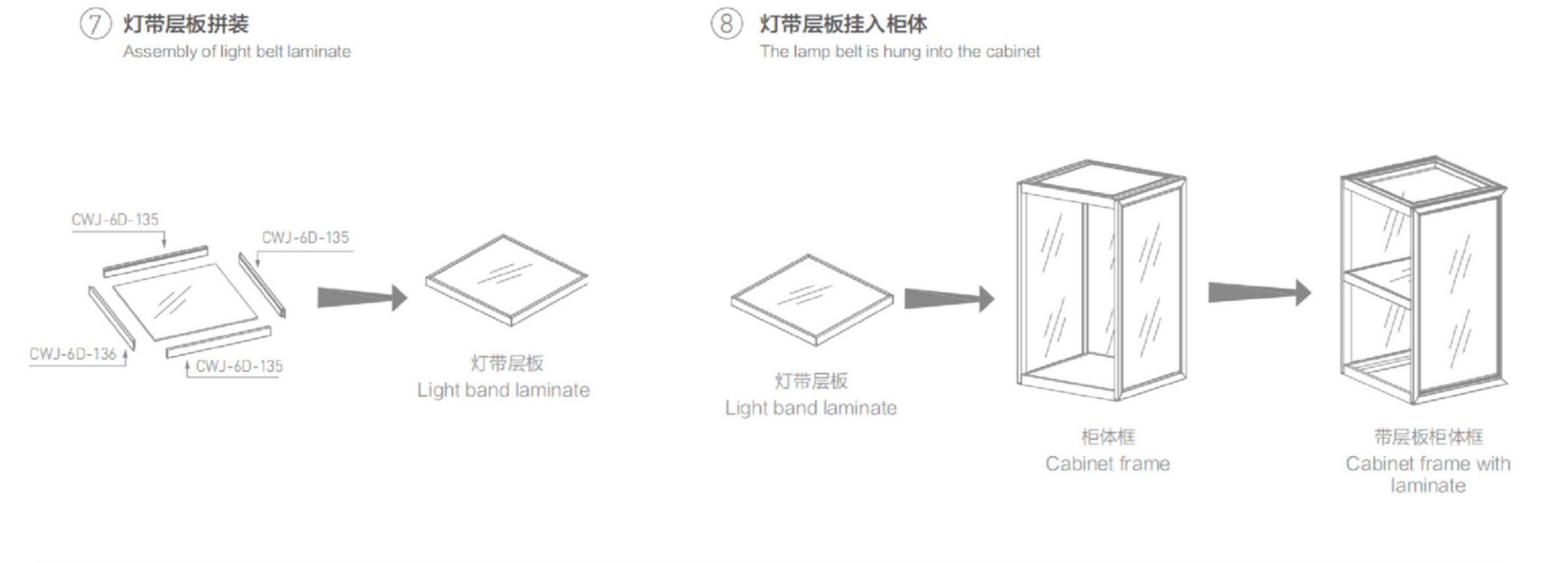
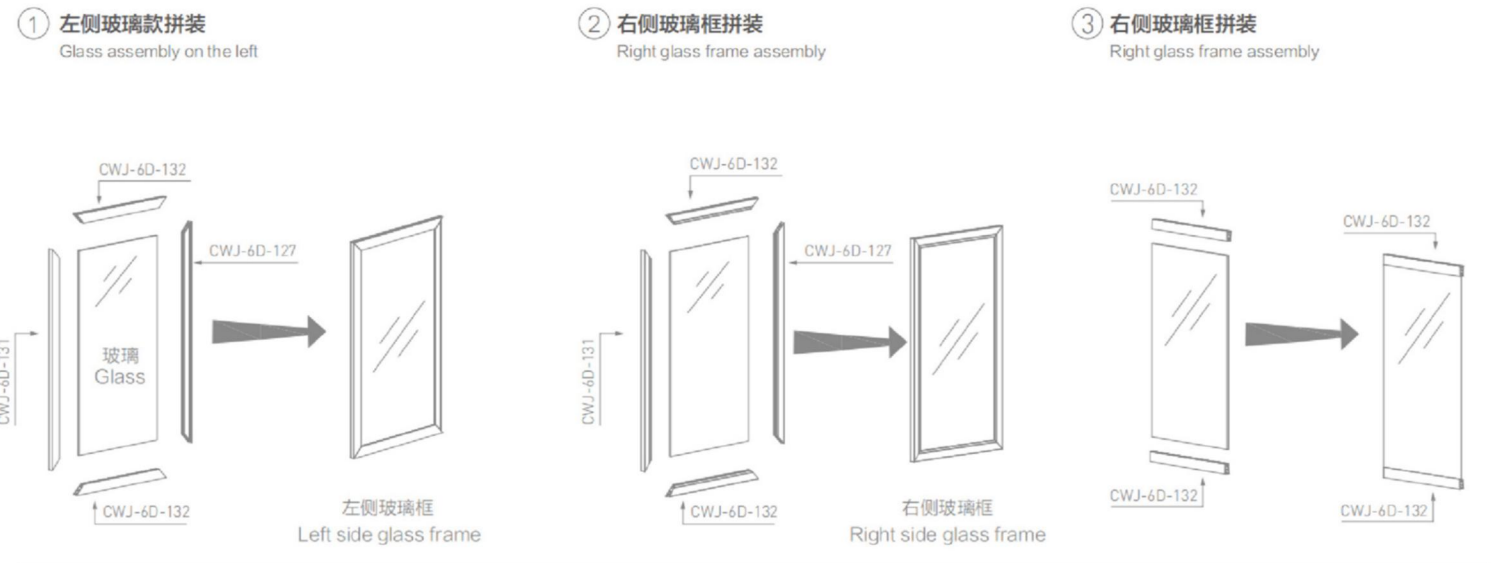

立柱柜系列 COLUMN WARDROBE



立柱柜系列DWG图纸 COLUMN WARDROBE DWG DRAWINGS

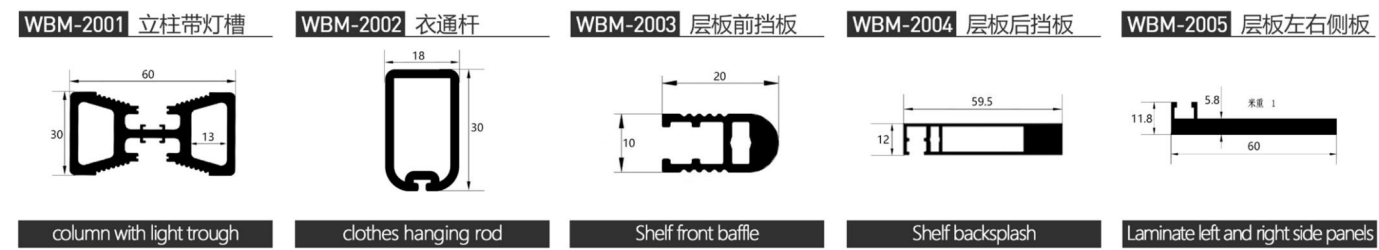

立柱式圆管书架系列 COLUMN TYPE ROUND TUBE BOOKSHELF SERIES

LJ-19302

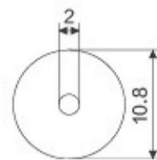

瓷泳黑
PORCELAIN
BLACK

拉丝金-1
BRUSHED
GOLD-1

壁厚: 4.4mm 米重: 0.264kg/m
Wall thickness: 4.4mm Meter weight: 0.264kg/m

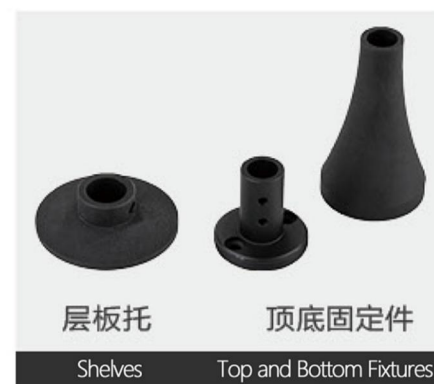

步入壁挂式衣帽间(玻璃层板) WALK INTO THE WALL-MOUNTED CLOSET

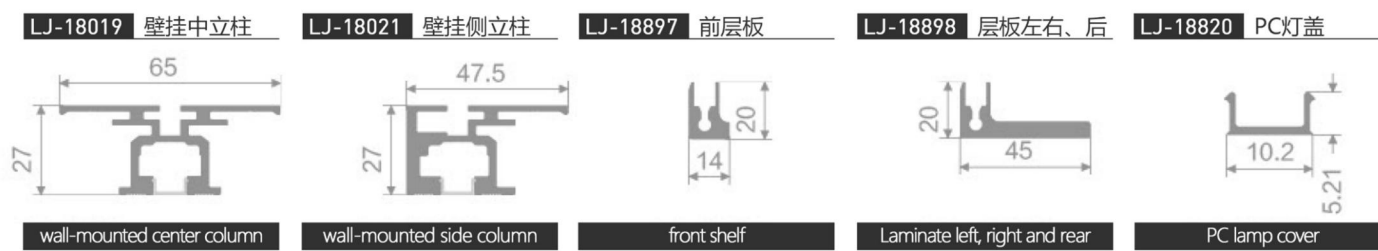

产品细节
PRODUCT DETAILS

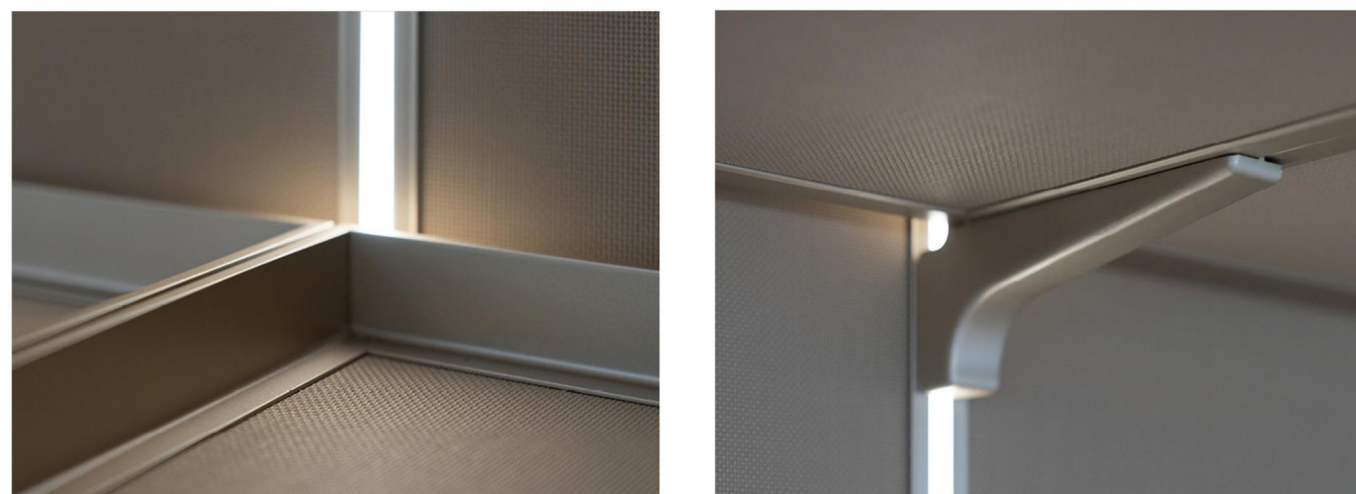

多色选择
POLYCHROMATIC SELECTION



厨房置物架系列 KITCHEN SHELF SERIES



酒杯托 / 铝吊杆
Wine Glass Holder / Aluminum Suspension Bar



酒杯架铝侧板
Wine glass holder aluminum side panel



灯盖
lamp cover

<p>LJ-18059 侧板盖板 side panel cover</p> <p>壁厚: 2.0mm Wall thickness: 2.0mm</p> <p>米重: 0.814kg/m Meter weight: 0.814kg/m</p>	<p>LJ-17497 侧板主体 Side panel body</p> <p>壁厚: 2.0mm Wall thickness: 2.0mm</p> <p>米重: 1.045kg/m Meter weight: 1.045kg/m</p>	<p>LJ-17498 顶底层板 top and bottom plate</p> <p>壁厚: 1.1mm Wall thickness: 1.1mm</p> <p>米重: 1.21kg/m Meter weight: 1.21kg/m</p>	<p>LJ-17499 隔板 Partition</p> <p>壁厚: 1.1mm Wall thickness: 1.1mm</p> <p>米重: 0.858kg/m Meter weight: 0.858kg/m</p>
--	---	--	---

<p>LJ-17524 墙壁挂件 wall hangings</p> <p>壁厚: 2.0mm Wall thickness: 2.0mm</p> <p>米重: 0.143kg/m Meter weight: 0.143kg/m</p>	<p>LJ-17518 顶底收口 Top and bottom closure</p> <p>壁厚: 2.5mm Wall thickness: 2.5mm</p> <p>米重: 0.451kg/m Meter weight: 0.451kg/m</p>	<p>LJ-17500 圆管 round tube</p> <p>壁厚: 4.2mm Wall thickness: 4.2mm</p> <p>米重: 0.308kg/m Meter weight: 0.308kg/m</p>	<p>LJ-19550 转换条 conversion bar</p> <p>壁厚: 1.3mm Wall thickness: 1.3mm</p> <p>米重: 0.103kg/m Meter weight: 0.103kg/m</p>
---	--	--	---



20 铰链与 25 铰链门缝减尺示意图

20 HINGE AND 25 HINGE DOOR SEAM SIZING DIAGRAM

NOTES FOR ORDER

下单备注事项

款式名称: (例: 20 极简框)

门型颜色: (例: 绅士灰)

玻璃颜色: (例: 灰玻)

门型净尺寸: 高 H * 宽 W

开启方向: 左开 / 右开 / 上翻门 / 下翻门

拉手位置 (H1): 拉手底端距离门型底端高度 (如下图)

铰链孔位置: X1、X2、X3、X4..... (如下图)

拉手长度: L (如下图)

Style name: (example: 20 minimalist box)

Door color: (example: gentleman grey)

Glass color: (example: gray glass)

Net size of door type: h * W

Opening direction: left / right / up / down

Handle position (H1): the height between the bottom of handle and the bottom of door type (as shown in the figure below)

Position of hinge hole: x1, X2, X3, X4... (as shown in the figure below)

Handle length: l (as shown in the figure below)

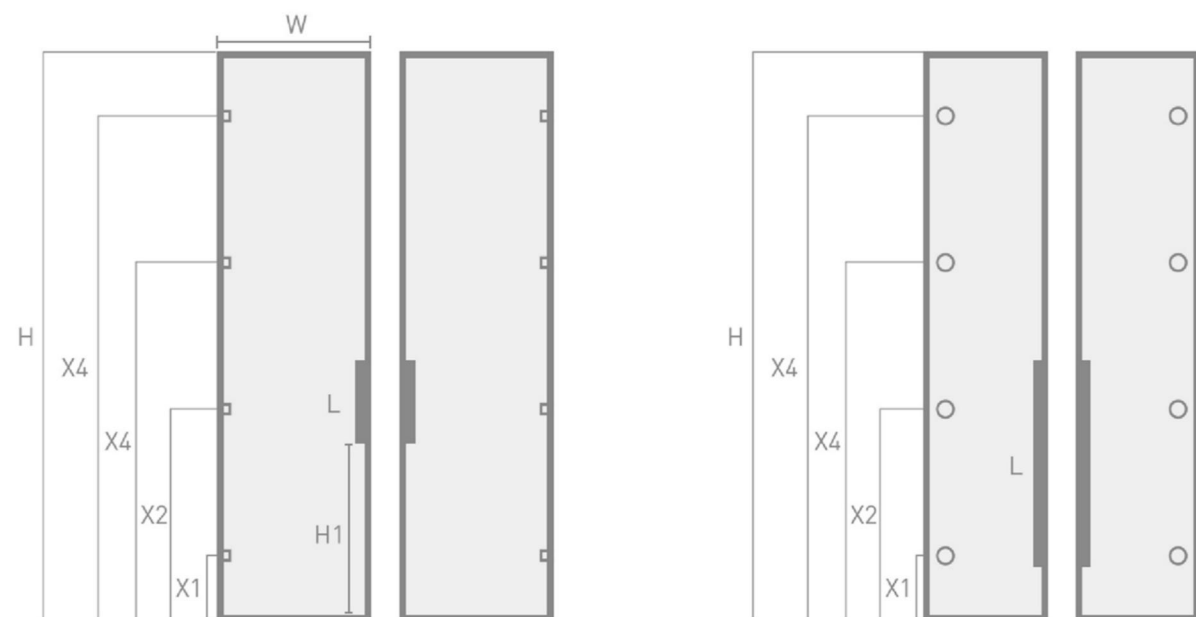

20 铰链与 25 铰链门缝减尺示意图

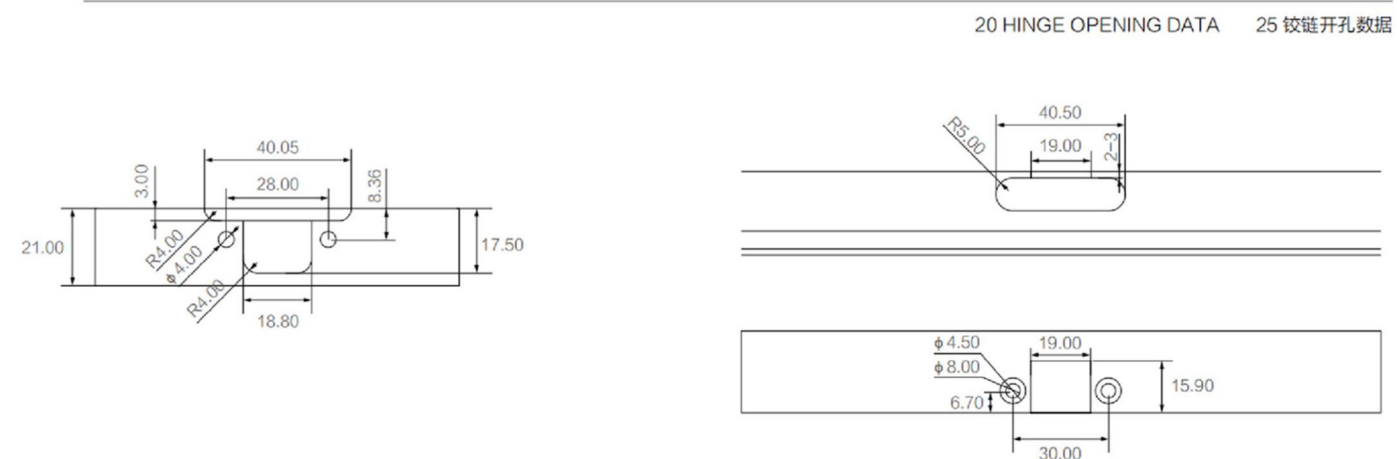
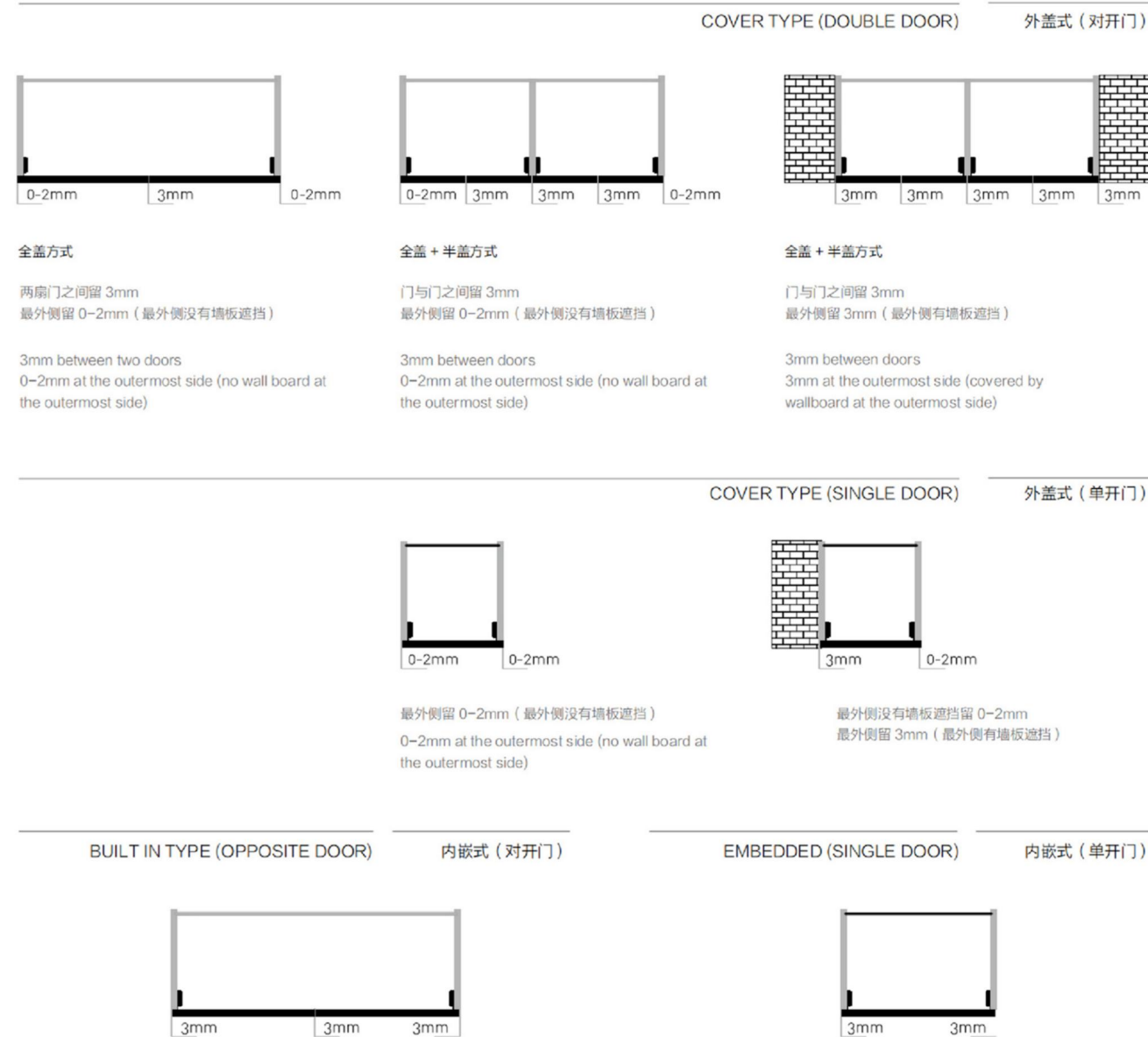

20 极简框 20 MINIMALIST BOX



门型编号 / Door type No: CWJ-6D-141 + CWJ-6D-142

铰链 / Hinge: 20 铰链 (Hinge)

玻璃颜色 / Glass color: 欧洲灰 / 金茶 / 灰茶 / 白玻 / 超白玻 / 黑玻 / 长虹玻璃 / 大灯芯 / 小灯芯
European grey / Golden Tea / Grey Tea / white glass / super white glass / Black Glass / Changhong glass / headlamp wick / small wick

拉手长度 / Handle length: 200mm / 1100mm / 通体拉手 (All over handle)

尺寸限定 / Size limit: (200mm ≤ W ≤ 900mm) (200mm ≤ H ≤ 2850mm)

玻璃减尺 / Glass reduction: -5mm

20 极简 F 款 (带防撞胶条) 20 MINIMALIST F (WITH ANTI-COLLISION ADHESIVE STRIP)



门型编号 / Door type No: CWJ-6D-164 + CWJ-6D-166

铰链 / Hinge: 20 铰链 (Hinge)

玻璃颜色 / Glass color: 欧洲灰 / 金茶 / 灰茶 / 白玻 / 超白玻 / 黑玻 / 长虹玻璃 / 大灯芯 / 小灯芯
European grey / Golden Tea / Grey Tea / white glass / super white glass / Black Glass / Changhong glass / headlamp wick / small wick

拉手长度 / Handle length: 200mm / 1100mm / 通体拉手 (All over handle)

尺寸限定 / Size limit: (200mm ≤ W ≤ 900mm) (200mm ≤ H ≤ 2850mm)

玻璃减尺 / Glass reduction: -5mm

20 经典款一字铰链框 (带格栅) CLASSIC STYLE 20MM SOFT CLOSE HINGE (WITH GRILLE)

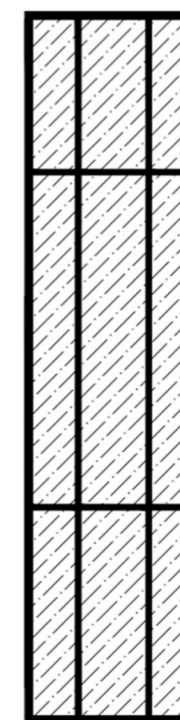
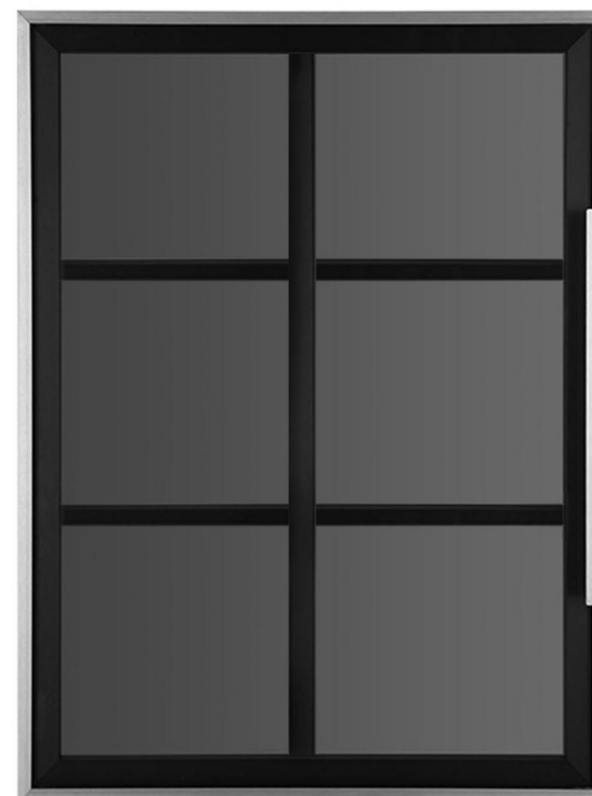

WAB-1002

WAB-1001

WAB-1003

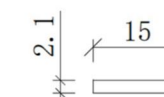
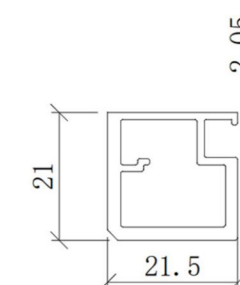
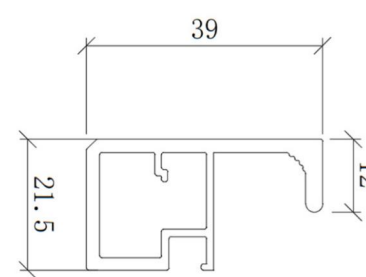



通用款式：20/25 铰链款，均可做带圆管
Applicable style : 20 / 25 hinge, can be made with round tube

20 框 G 型拉手款 (需配堵头) 20 FRAME G-TYPE HANDLE (WITH PLUG)



- 
瓷泳黑
PORCELAIN
BLACK
- 
深海灰
DEEP SEA
GRAY
- 
拉丝金-1
BRUSHED
GOLD-1
- 
黑色
BLACK
- 
法兰咖
COFFEE
- 
纳多灰
GRAY
- 
琉璃金
GLAZED
GOLD
- 
拉丝金-2
BRUSHED
GOLD-2



CWJ-6D-253

CWJ-6D-141

门型编号 / Door type No: CWJ-6D-253+ CWJ-6D-141

铰链 / Hinge: 20 铰链 (Hinge)

玻璃颜色 / Glass color: 欧洲灰 / 金茶 / 灰茶 / 白玻 / 超白玻 / 黑玻 / 长虹玻璃 / 大灯芯 / 小灯芯
European grey / Golden Tea / Grey Tea / white glass / super white glass / Black Glass /
Changhong glass / headlamp wick / small wick

拉手长度 / Handle length: 通体拉手 (All over handle)

尺寸限定 / Size limit: (200mm ≤ W ≤ 900mm) (200mm ≤ H ≤ 2850mm)

玻璃减尺 / Glass reduction: -5mm

20 框 U 型拉手款 20 FRAME U-SHAPED HANDLE



- 
瓷泳黑
PORCELAIN
BLACK
- 
深海灰
DEEP SEA
GRAY
- 
拉丝金-1
BRUSHED
GOLD-1
- 
黑色
BLACK
- 
法兰咖
COFFEE
- 
纳多灰
GRAY
- 
琉璃金
GLAZED
GOLD
- 
拉丝金-2
BRUSHED
GOLD-2



CWJ-6D-254

CWJ-6D-141

门型编号 : CWJ-6D-254+ CWJ-6D-141

铰链 / Hinge: 20 铰链 (Hinge)

玻璃颜色 / Glass color: 欧洲灰 / 金茶 / 灰茶 / 白玻 / 超白玻 / 黑玻 / 长虹玻璃 / 大灯芯 / 小灯芯
European grey / Golden Tea / Grey Tea / white glass / super white glass / Black Glass / Changhong
glass / headlamp wick / small wick

拉手长度 / Handle length: 通体拉手 (All over handle)

尺寸限定 / Size limit: (200mm ≤ W ≤ 900mm) (200mm ≤ H ≤ 2850mm)

玻璃减尺 / Glass reduction: -5mm

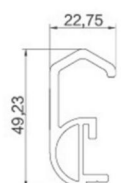
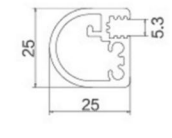
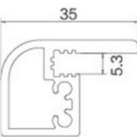
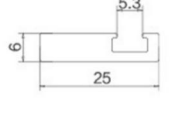

20框圆弧系列 20 FRAME ARC SERIES

20 框悬浮拉手 20 frame suspension handle



<p>LJ-10070 拉手 handle</p>  <p>壁厚: 3.0mm 米重: 0.895kg/m Wall thickness: 3.0mm Meter weight: 0.895kg/m</p>	<p>LJ-10066 圆弧拉手框 Arc handle frame</p>  <p>壁厚: 2.0mm 米重: 0.624kg/m Wall thickness: 2.0mm Meter weight: 0.624kg/m</p>
<p>LJ-10069 铰链框 hinged frame</p>  <p>壁厚: 2.0mm 米重: 0.733kg/m Wall thickness: 2.0mm Meter weight: 0.733kg/m</p>	<p>LJ-10067 上下框 upper and lower frame</p>  <p>壁厚: 6.0mm 米重: 0.371kg/m Wall thickness: 6.0mm Meter weight: 0.371kg/m</p>

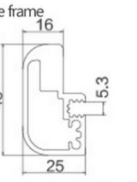
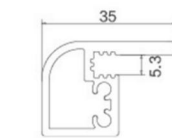
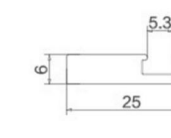

20 框圆弧通体拉手 20 frame arc whole body handle

<p>LJ-10068 通体拉手框 Whole body handle frame</p>  <p>壁厚: 2.0mm 米重: 1.243kg/m Wall thickness: 2.0mm Meter weight: 1.243kg/m</p>	<p>LJ-10069 铰链框 hinged frame</p>  <p>壁厚: 2.0mm 米重: 0.733kg/m Wall thickness: 2.0mm Meter weight: 0.733kg/m</p>	<p>LJ-10067 上下框 upper and lower frame</p>  <p>壁厚: 6.0mm 米重: 0.371kg/m Wall thickness: 6.0mm Meter weight: 0.371kg/m</p>	<p>堵头 LJ-10066 堵头 LJ-10068 堵头 plug</p> 
---	--	---	---

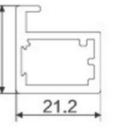
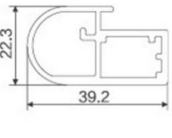
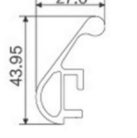
20 框圆弧拉手 20 Arc handle frame

<p>LJ-10063 边框 frame</p>  <p>壁厚: 2.0mm 米重: 0.457kg/m Wall thickness: 2.0mm Meter weight: 0.457kg/m</p>	<p>LJ-10064 22 圆弧框 22 arc frame</p>  <p>壁厚: 2.0mm 米重: 0.699kg/m Wall thickness: 2.0mm Meter weight: 0.699kg/m</p>	<p>LJ-10065 拉手 handle</p>  <p>壁厚: 2.0mm 米重: 1.029kg/m Wall thickness: 2.0mm Meter weight: 1.029kg/m</p>	<p>配件 护角 corner guard 连接件 connector 堵头 plug</p> 
--	---	--	--

20 极简拇指款 (带防撞胶条) 20 MINIMALIST THUMB (WITH ANTI-COLLISION TAPE)

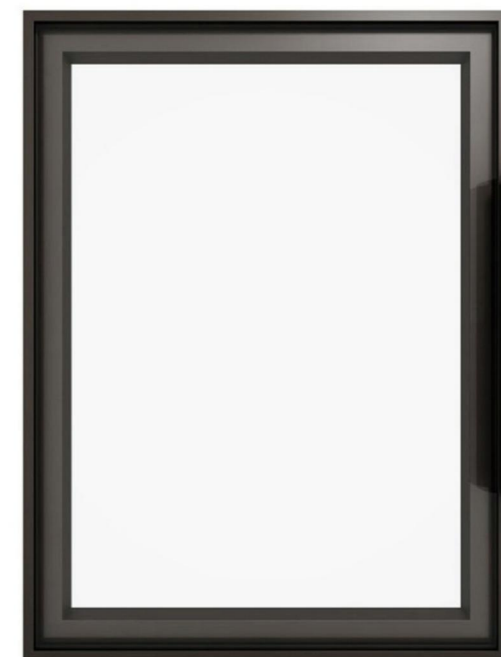

--	--	--	--	--	--	--	--



CWJ-6D-164 CWJ-6D-165

门型编号 / Door type No: CWJ-6D-164 + CWJ-6D-165

铰链 / Hinge: 20 铰链 (Hinge)

玻璃颜色 / Glass color: 欧洲灰 / 金茶 / 灰茶 / 白玻 / 超白玻 / 黑玻 / 长虹玻璃 / 大灯芯 / 小灯芯
European grey / Golden Tea / Grey Tea / white glass / super white glass / Black Glass / Changhong glass / headlamp wick / small wick

拉手长度 / Handle length: 200mm / 1100mm / 通体拉手 (All over handle)

尺寸限定 / Size limit: (200mm ≤ W ≤ 900mm) (200mm ≤ H ≤ 2850mm)

玻璃减尺 / Glass reduction: -5mm



35 铰链门缝减尺示意图

20 HINGE AND 25 HINGE DOOR SEAM SIZING DIAGRAM

技术信息 Technical information



铰链又称合页，是用来连接两个固体并允许两者之间做相对转动的机械装置。铰链可由可移动的组件构成，或者由可折叠的材料构成。

Hinge, also known as hinge, is a mechanical device used to connect two solids and allow relative rotation between them. The hinge can be made of movable components or foldable materials.

铰杯内置集成阻尼铰链并外置装饰盖。
开门角度：90度~110度
安装方式：开槽安装
螺丝可调节为1-2mm的深度
铰杯大小33mm / 铰杯厚度11.5mm

The hinge cup is internally integrated with damping hinge and externally equipped with decorative cover.
Door opening angle: 90 ~ 110 degrees
Installation method: slotted installation
The screw can be adjusted to a depth of 1-2mm
Hinge cup size 33mm / hinge cup thickness 11.5mm

开孔示意图 Opening diagram

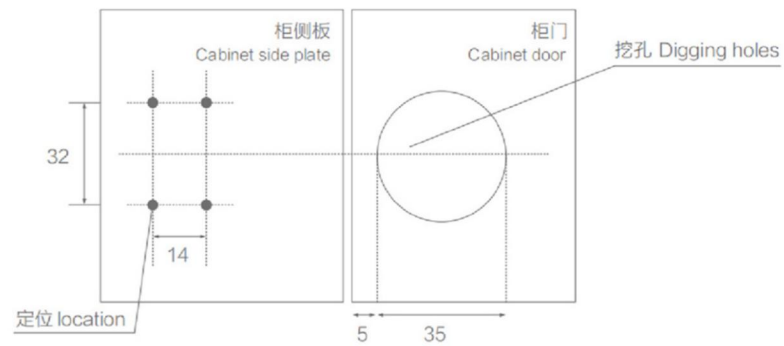

INSTALLATION PROCEDURE 安装步骤

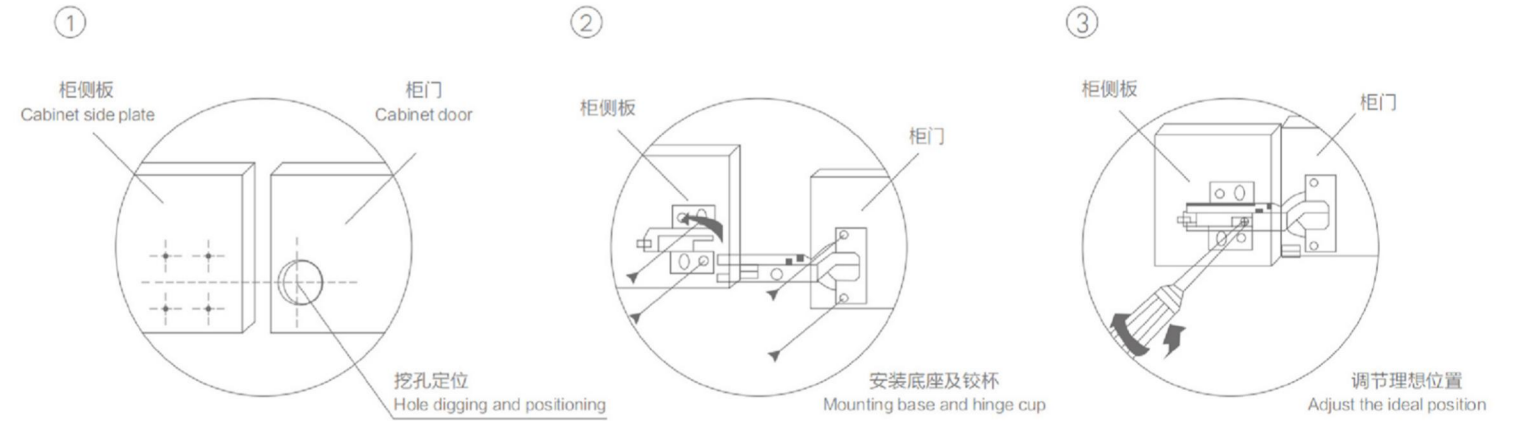

SCHEMATIC DIAGRAM OF REGULATING CABINET DOOR 调节柜门示意

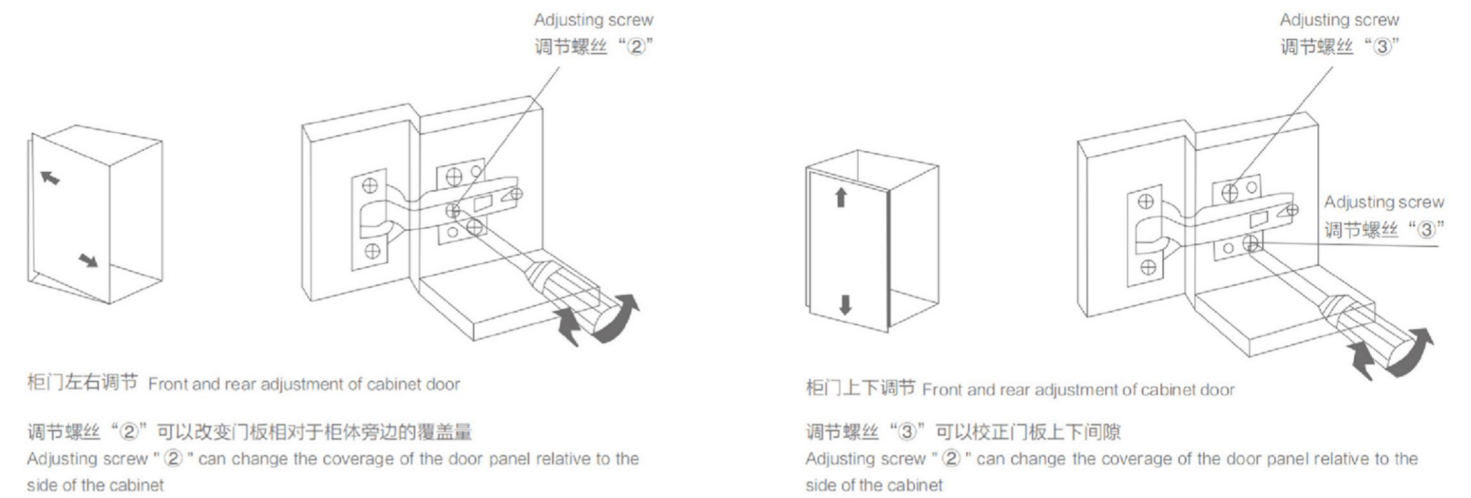
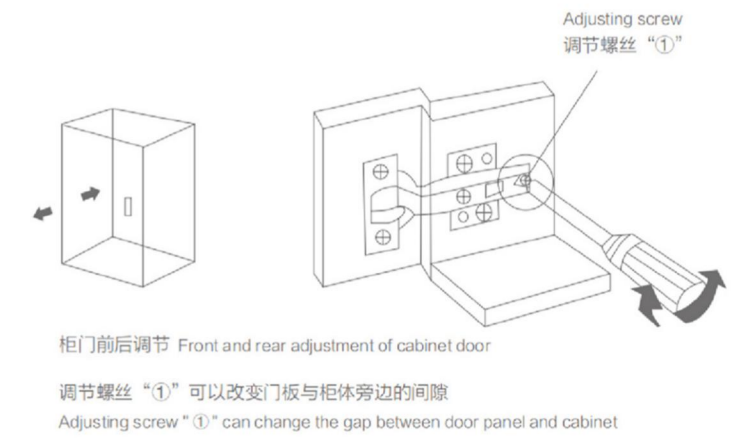

博洛尼系列 THE BOLONI SERIES

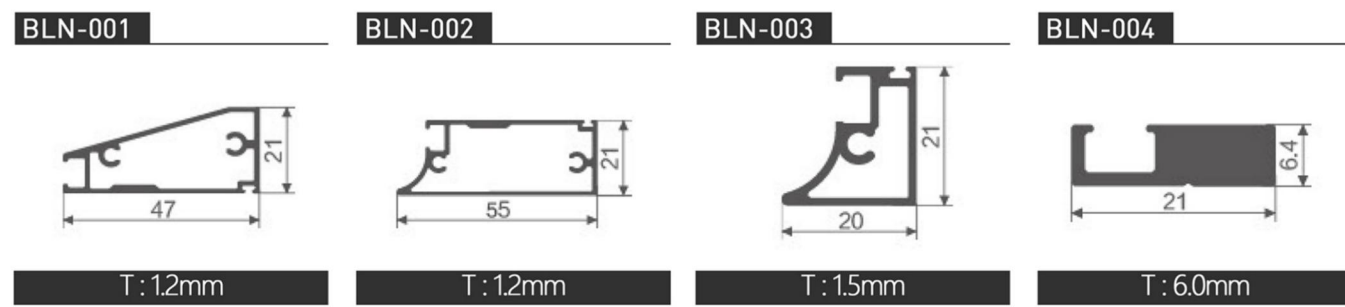
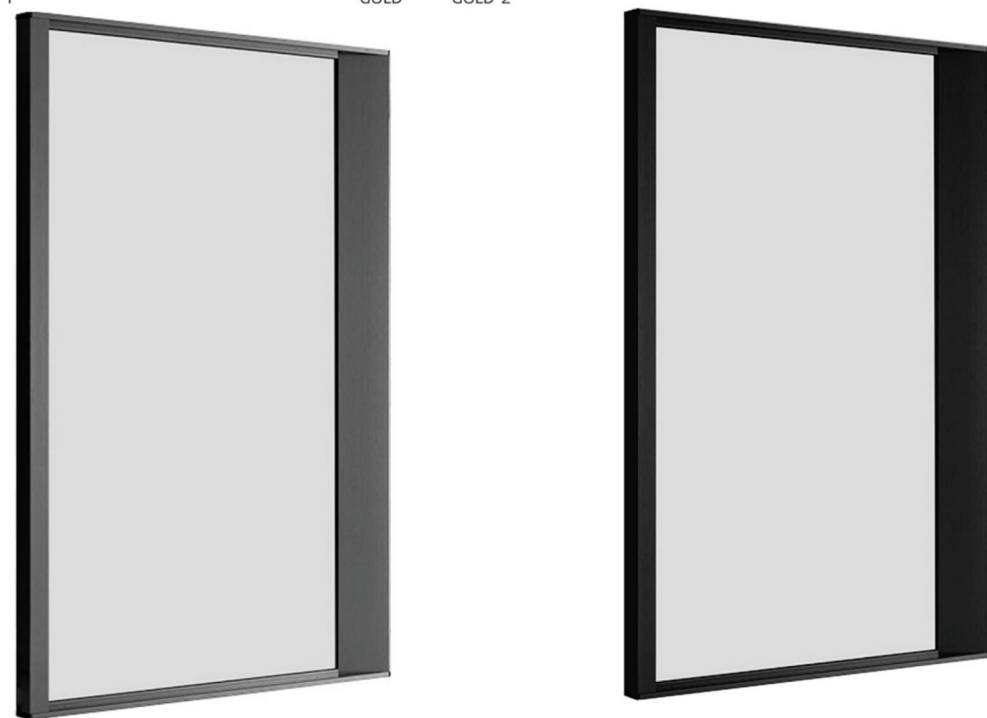

极致系列 EXTREME SERIES

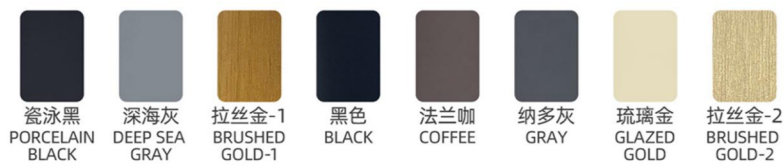

65 门框 65 DOOR FRAME

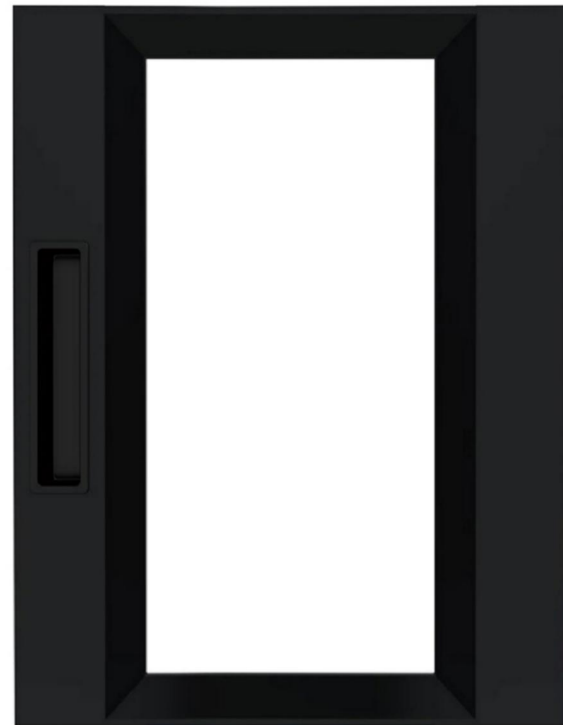

门型编号 / Door type No: CWJ-6D-190 + CWJ-6D-191
 铰链 / Hinge: 35 铰链 (Hinge)
 玻璃颜色 / Glass color: 欧洲灰 / 金茶 / 灰茶 / 白玻 / 超白玻 / 黑玻 / 长虹玻璃 / 大灯芯 / 小灯芯
 European grey / Golden Tea / Grey Tea / white glass / super white glass / Black Glass / Changhong glass / headlamp wick / small wick
 拉手长度 / Handle length: 160mm (嵌入式 Embedded)
 尺寸限定 / Size limit: (200mm ≤ W ≤ 900mm) (200mm ≤ H ≤ 2850mm)
 玻璃减尺 / Glass reduction: 宽边 Wide edge -118mm, 窄边 Narrow side -36mm

50 斜边框 65 DOOR FRAME



门型编号 / Door type No: CWJ-6D-121 + CWJ-6D-120
 铰链 / Hinge: 35 铰链 (Hinge)
 玻璃颜色 / Glass color: 欧洲灰 / 金茶 / 灰茶 / 白玻 / 超白玻 / 黑玻 / 长虹玻璃 / 大灯芯 / 小灯芯
 European grey / Golden Tea / Grey Tea / white glass / super white glass / Black Glass / Changhong glass / headlamp wick / small wick
 拉手长度 / Handle length: 160mm (嵌入式 Embedded)
 尺寸限定 / Size limit: (200mm ≤ W ≤ 900mm) (200mm ≤ H ≤ 2850mm)
 玻璃减尺 / Glass reduction: 宽边 Wide edge -91mm, 窄边 Narrow side -11mm

3mm 镜框 3 MM PICTURE FRAME

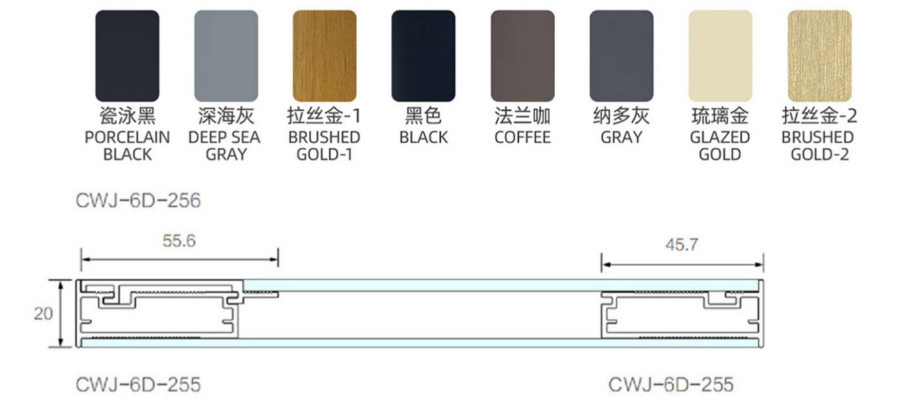

门型编号 / Door type No: CWJ-6D-190 + CWJ-6D-191
 铰链 / Hinge: 35 铰链 (Hinge)
 玻璃颜色 / Glass color: 欧洲灰 / 金茶 / 灰茶 / 白玻 / 超白玻 / 黑玻 / 长虹玻璃 / 大灯芯 / 小灯芯
 European grey / Golden Tea / Grey Tea / white glass / super white glass / Black Glass / Changhong glass / headlamp wick / small wick
 拉手长度 / Handle length: 160mm (嵌入式 Embedded)
 尺寸限定 / Size limit: (200mm ≤ W ≤ 900mm) (200mm ≤ H ≤ 2850mm)
 玻璃减尺 / Glass reduction: 宽边 Wide edge -118mm, 窄边 Narrow side -36mm

博洛尼通体拉手 BOLONI WHOLE BODY HANDLE FRAME

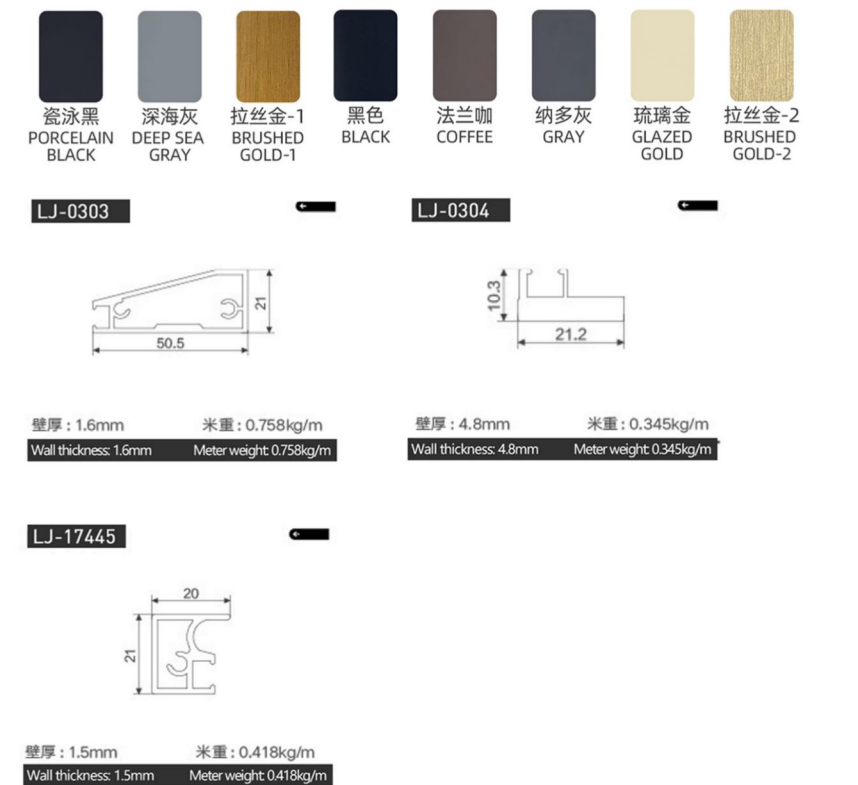

45 门框 45 DOOR FRAME



门型编号 / Door type No: CWJ-6D-172 + CWJ-6D-173

铰链 / Hinge: 35 铰链 (Hinge)

玻璃颜色 / Glass color: 欧洲灰 / 金茶 / 灰茶 / 白玻 / 超白玻 / 黑玻 / 长虹玻璃 / 大灯芯 / 小灯芯
European grey / Golden Tea / Grey Tea / white glass / super white glass / Black Glass / Changhong glass / headlamp wick / small wick

拉手长度 / Handle length: 200mm / 1100mm / 通体拉手 All over handle

尺寸限定 / Size limit: (200mm ≤ W ≤ 900mm) (200mm ≤ H ≤ 2850mm)

玻璃减尺 / Glass reduction: -6mm

50 方框 (可带灯光) 50 BOX (WITH LIGHT)



门型编号 / Door type No: CWJ-6D-260 + CWJ-6D-261

铰链 / Hinge: 35 铰链 (Hinge)

玻璃颜色 / Glass color: 欧洲灰 / 金茶 / 灰茶 / 白玻 / 超白玻 / 黑玻 / 长虹玻璃 / 大灯芯 / 小灯芯
European grey / Golden Tea / Grey Tea / white glass / super white glass / Black Glass / Changhong glass / headlamp wick / small wick

拉手长度 / Handle length: 通体拉手 All over handle

尺寸限定 / Size limit: (200mm ≤ W ≤ 900mm) (200mm ≤ H ≤ 2850mm)

玻璃减尺 / Glass reduction: -6

45 宽边门板圆杯铰链 45MM WIDE DOOR PANEL ROUND CUP HINGE

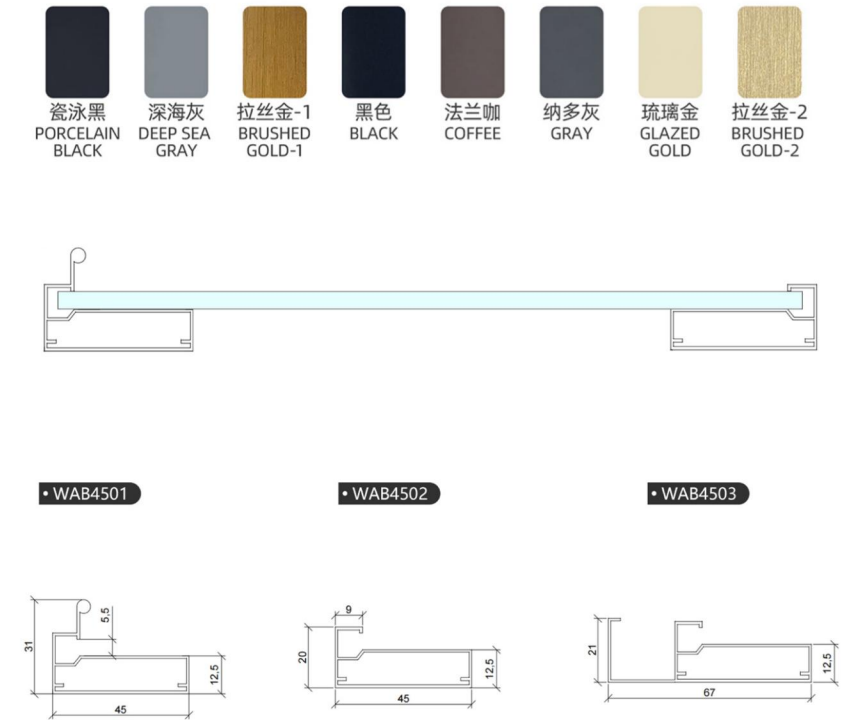

内嵌拉手玻璃门 BUILT-IN HANDLE GLASS DOOR

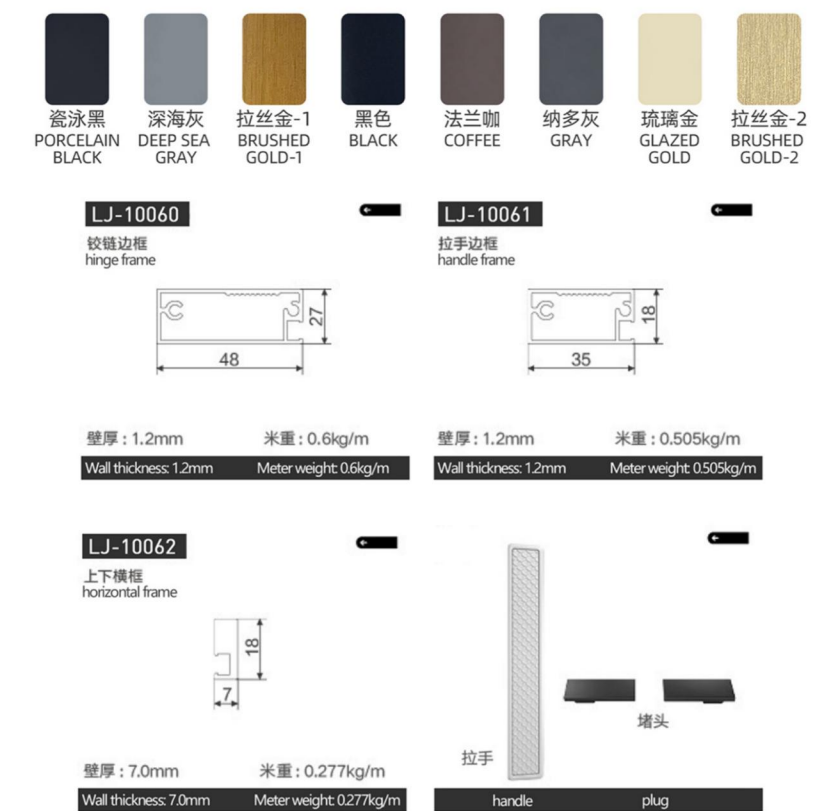
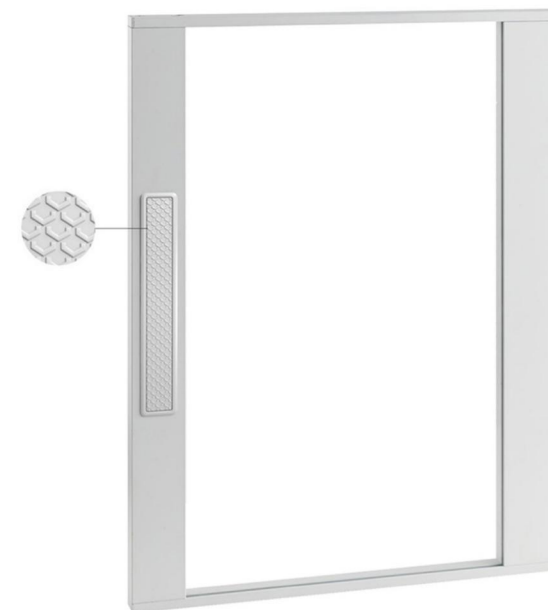

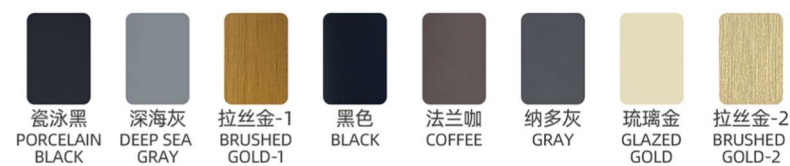

跑车铰链 弧形框 ROADSTER HINGED CURVED FRAME

黑玻 / 长虹玻璃 / 大灯芯 / 小灯芯
 ite glass / Black Glass /

over handle

$1 \leq H \leq 2850\text{mm}$)



CWJ-6D-245

CWJ-6D-246



- 1、结构简单、尺寸任意、安全牢固
- 2、功能百变、办公居家均能为你分割出理想的空间
- 3、模块化的设计，不仅安装简单更能按照你的使用习惯随意组装

1. Simple structure, arbitrary size, safe and firm
2. Function change, office and home can divide the ideal space for you
3. Modular design, not only easy to install, but also can be assembled according to your habits

方型天地铰链25门框(可配25铰链) DOORFRAME WITH SQUARE EARTH AND EARTH HINGE 25 (CAN BE MATCHED WITH 25 HINGES)

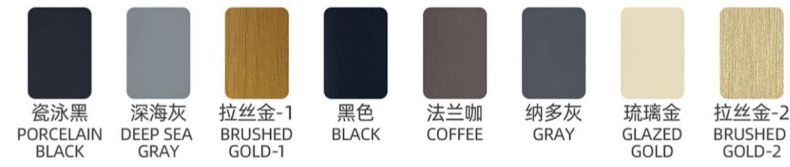

门型编号 / Door type No: CWJ-6D-123 + CWJ-6D-122
 铰链 / Hinge: 天地铰链 pivot hinge / 25 铰链 hinge
 玻璃颜色 / Glass color: 欧洲灰 / 金茶 / 灰茶 / 白玻 / 超白玻 / 黑玻 / 长虹玻璃 / 大灯芯 / 小灯芯
 European grey / Golden Tea / Grey Tea / white glass / super white glass / Black Glass / Changhong glass / headlamp wick / small wick
 拉手长度 / Handle length: 200mm / 1100mm / 通体拉手 All over handle
 尺寸限定 / Size limit: (200mm ≤ W ≤ 900mm) (200mm ≤ H ≤ 2850mm)
 玻璃减尺 / Glass reduction: -6mm

25拉手分体门框 25 HANDLE SPLIT DOOR FRAME

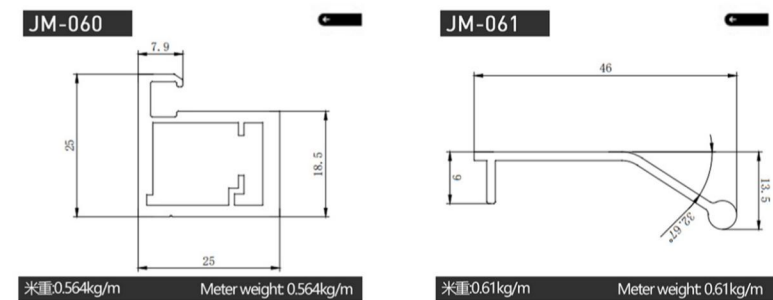

米重: 0.564kg/m Meter weight: 0.564kg/m
 米重: 0.61kg/m Meter weight: 0.61kg/m

导弹框 MISSILE BOX



门型编号 / Door type No: CWJ-6D-221 + CWJ-6D-222
 铰链 / Hinge: 天地铰链 pivot hinge
 玻璃颜色 / Glass color: 欧洲灰 / 金茶 / 灰茶 / 白玻 / 超白玻 / 黑玻 / 长虹玻璃 / 大灯芯 / 小灯芯
 European grey / Golden Tea / Grey Tea / white glass / super white glass / Black Glass / Changhong glass / headlamp wick / small wick
 拉手长度 / Handle length: 200mm / 1100mm / 通体拉手 All over handle
 尺寸限定 / Size limit: (200mm ≤ W ≤ 900mm) (200mm ≤ H ≤ 2850mm)
 玻璃减尺 / Glass reduction: -6mm





烟斗款框 (可配 25 铰链) PIPE FRAME (AVAILABLE WITH 25 HINGES)

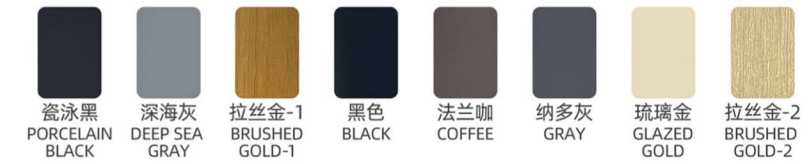

CWJ-6D-153

CWJ-6D-154

门型编号 / Door type No: CWJ-6D-153 + CWJ-6D-154

铰链 / Hinge: 天地铰链 pivot hinge / 25 铰链 hinge

玻璃颜色 / Glass color: 欧洲灰 / 金茶 / 灰茶 / 白玻 / 超白玻 / 黑玻 / 长虹玻璃 / 大灯芯 / 小灯芯
European grey / Golden Tea / Grey Tea / white glass / super white glass / Black Glass / Changhong glass / headlamp wick / small wick

拉手长度 / Handle length: 200mm / 1100mm / 通体拉手 All over handle

尺寸限定 / Size limit: (200mm ≤ W ≤ 900mm) (200mm ≤ H ≤ 2850mm)

玻璃减尺 / Glass reduction: -6mm

30 弧形框 30 CURVED BOX



CWJ-6D-146

CWJ-6D-147

门型编号 / Door type No: CWJ-6D-194 + CWJ-6D-193

铰链 / Hinge: 天地铰链 pivot hinge

玻璃颜色 / Glass color: 欧洲灰 / 金茶 / 灰茶 / 白玻 / 超白玻 / 黑玻 / 长虹玻璃 / 大灯芯 / 小灯芯
European grey / Golden Tea / Grey Tea / white glass / super white glass / Black Glass / Changhong glass / headlamp wick / small wick

拉手长度 / Handle length: 200mm / 1100mm / 通体拉手 All over handle

尺寸限定 / Size limit: (200mm ≤ W ≤ 900mm) (200mm ≤ H ≤ 2850mm)

玻璃减尺 / Glass reduction: -6mm

轻型天地铰链框系列 TIANTIANJIAO CHAIN FRAME SERIES



27 圆弧天地铰链框 27 arc air hinge frame

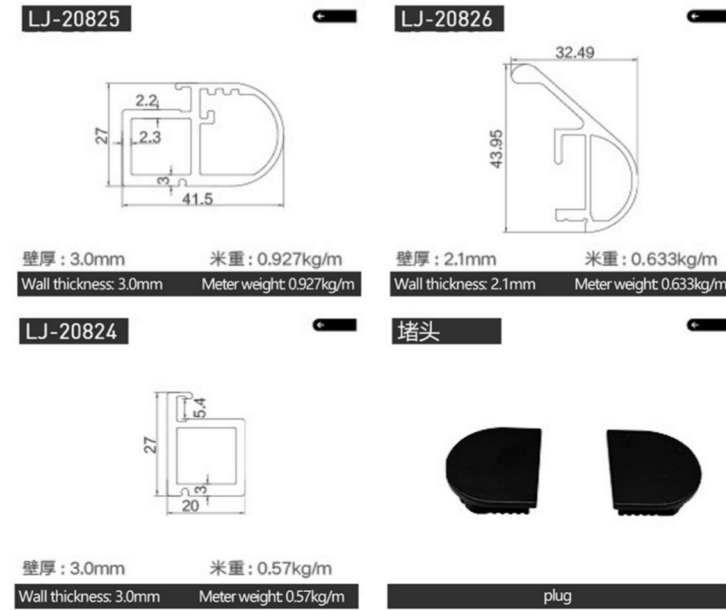

HEAVY HINGE DOOR 重型天地铰链框系列



重型弧形天地框 Heavy-duty curved sky frame

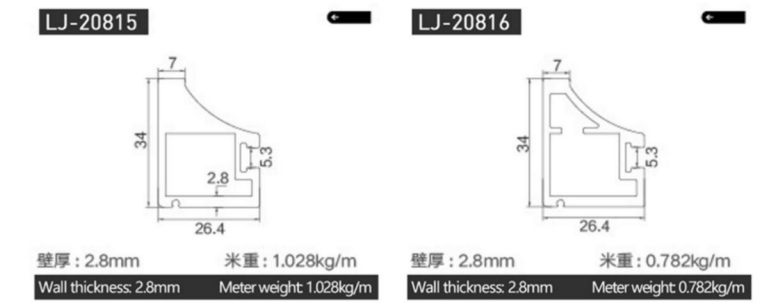

28 天地铰链框 28 air hinged frame

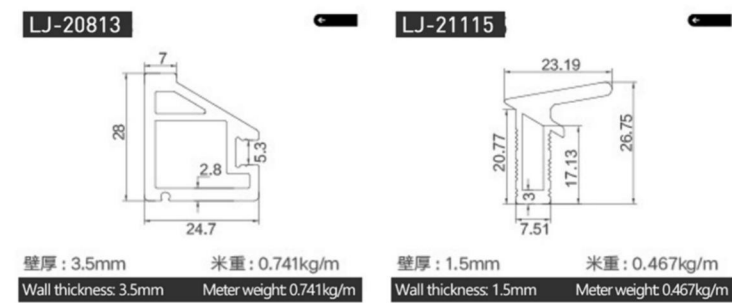

重型内嵌拉手天地框 Heavy built-in handle frame

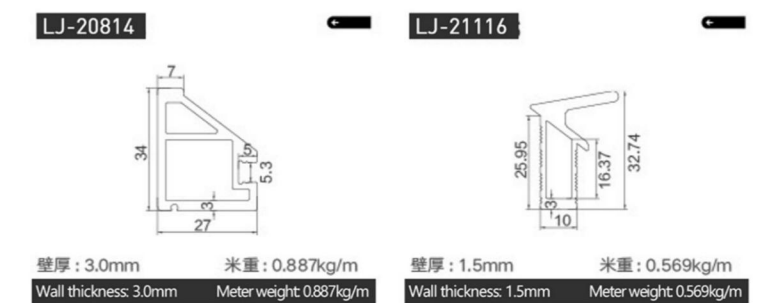

针式铰链系列门框 PIN HINGE SERIES DOOR FRAME

技术信息 Technical information

35 款天地铰链
35 models of heaven and earth hinge

最大盖位 Cover a largest: 17mm
深度调节 Depth adjustment: $-3.0\text{mm}/+3.0\text{mm}$
铝合金材质 Zinc alloy material: 喷涂 spraying

适用于 35mm 厚的专用铝框门体
Applicable to 35mm thick special aluminum frame door body

盖位调节 Cover a regulation: -3.0mm
上下调节 Adjust up and down: $-2.5\text{mm}/+2.5\text{mm}$
铝合金材质 Zinc alloy material: 氧化 spraying

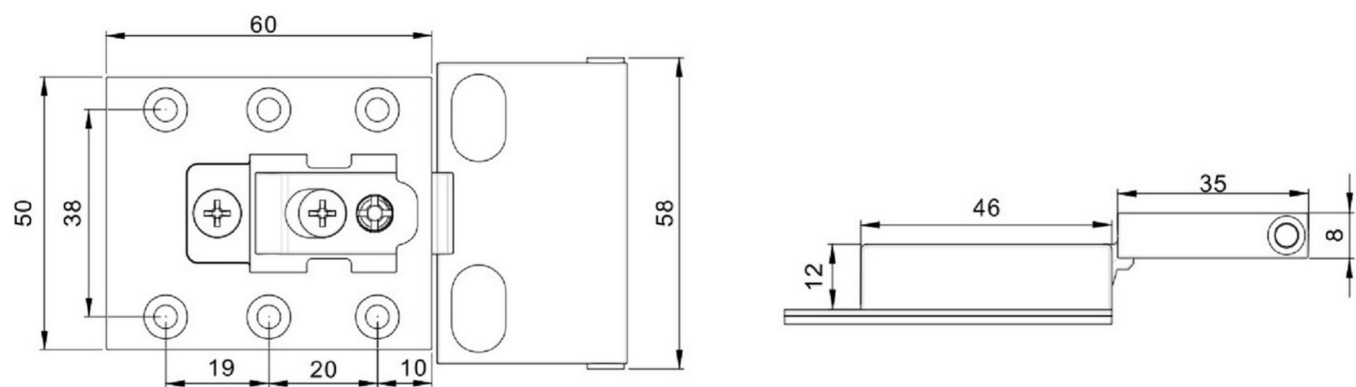

Hole size of cabinet side panel
柜体侧板开孔尺寸

Needle frame opening size
针式框开孔尺寸

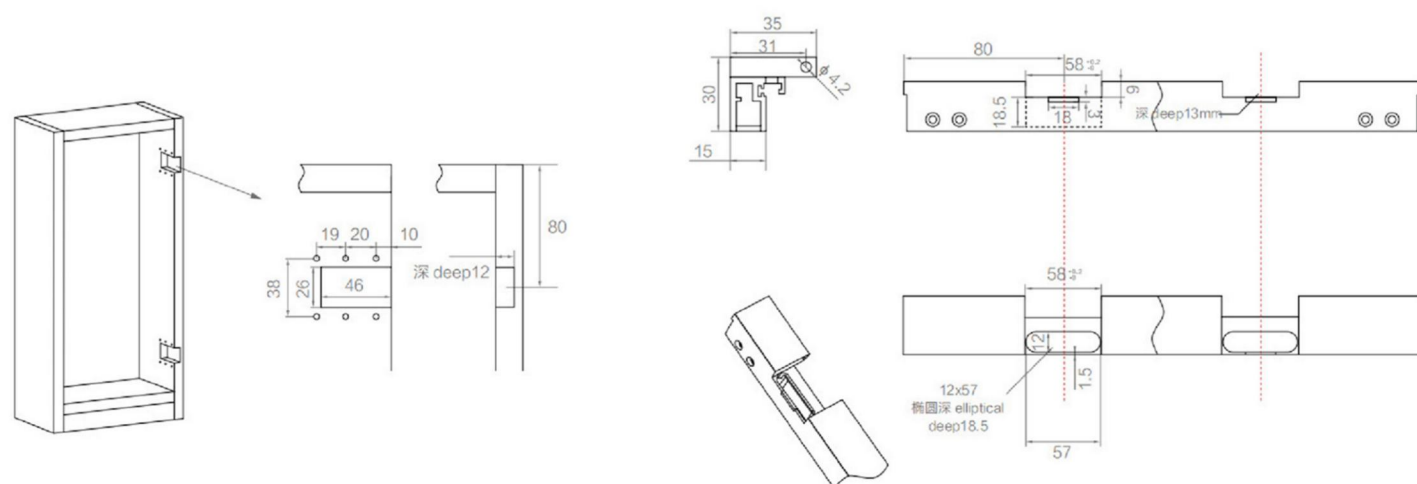

针式铰链系列门框

PIN HINGE SERIES DOOR FRAME

针式铰链玻璃门门缝示意图

SKETCH DIAGRAM OF NEEDLE HINGED GLASS DOOR

全盖 / 半盖 Fully covered/partially covered

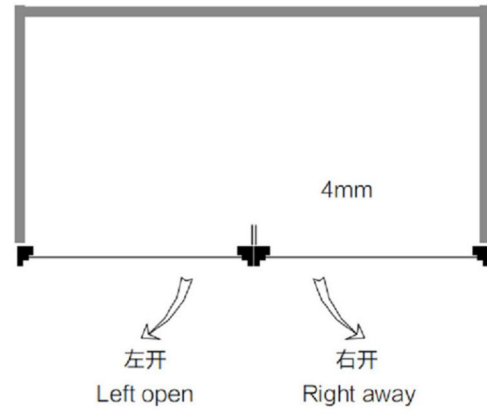

全盖 / 半盖 Fully covered/partially covered

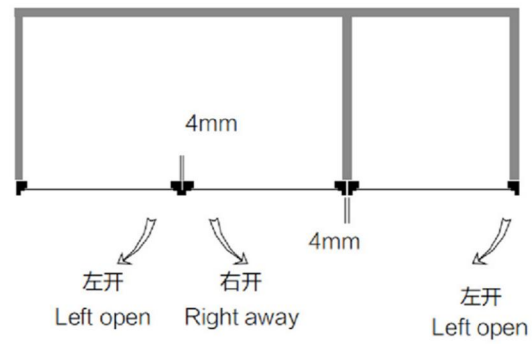

全盖 / 半盖 Fully covered/partially covered

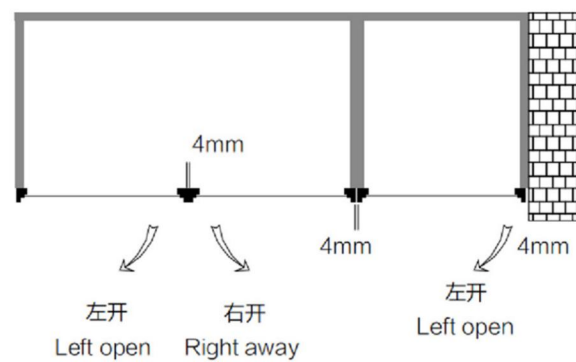

相邻两扇不可共用同一侧板
Adjacent two fans cannot share the same side plate

针式铰链玻璃平开门柜体开孔 / 安装调节示意图

Diagram of opening/installation adjustment of cabinet body with pin hinged glass flat door

框体侧板开孔尺寸图
Size drawing of side plate of frame body

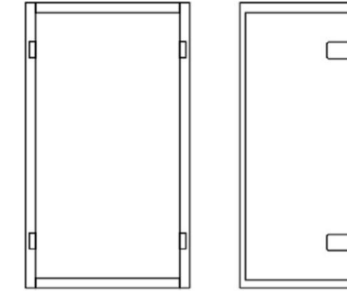

阻尼器装入铝框门
The damper is housed in an aluminium framed door

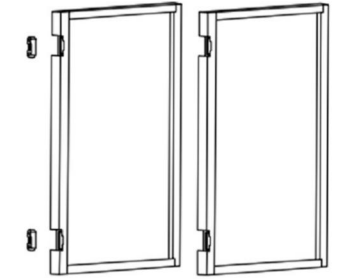

铰链本体装铝框门
Aluminum frame door with hinged body

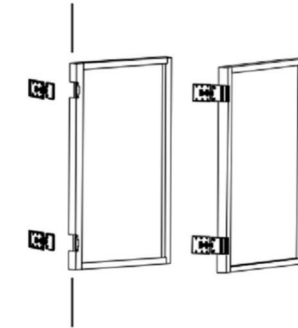

铝框门与柜体安装
Aluminum frame door and cabinet mounting

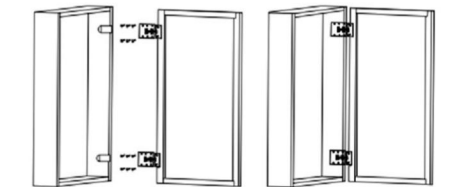

盖位调节 Cover a regulation: +/-1mm

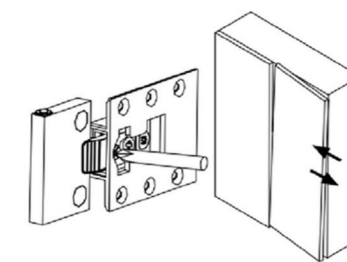

高度调节 Height adjustment: +/-2mm

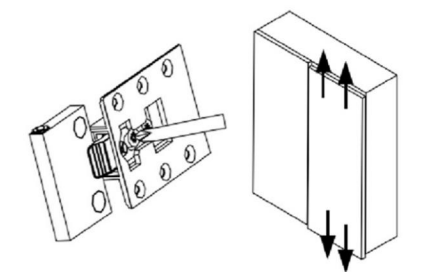

门板与侧板间隙调节: +/-1.5mm
Adjustment of gap between door panel and side panel: +/-1.5mm

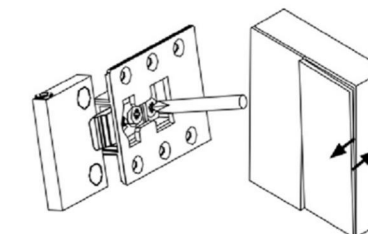

安装饰盖板
Install decorative cover plate

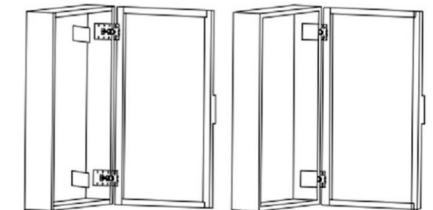

针式框 PIN TYPE BOX

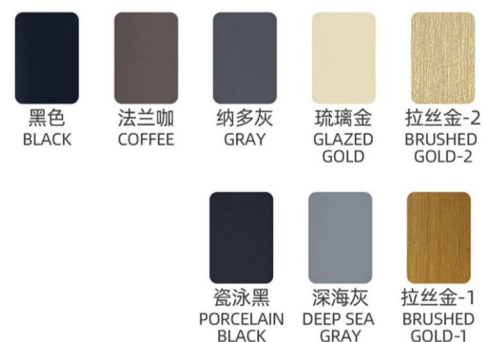
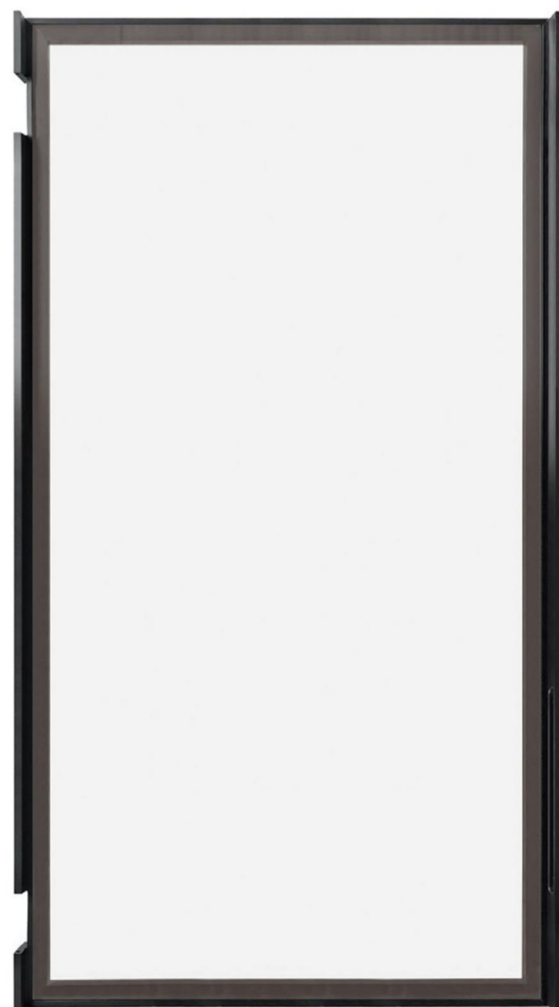

铰链 / Hinge: 针式铰链 Hinge pin type

玻璃颜色 / Glass color: 欧洲灰 / 金茶 / 灰茶 / 白玻 / 超白玻 / 黑玻 / 长虹玻璃 / 大灯芯 / 小灯芯
European grey / Golden Tea / Grey Tea / white glass / super white glass / Black Glass / Changhong glass / headlamp wick / small wick

拉手长度 / Handle length: 通体拉手 All over handle

尺寸限定 / Size limit: (200mm ≤ W ≤ 900mm) (200mm ≤ H ≤ 2850mm)

玻璃减尺 / Glass reduction: 宽边 broadside-22mm, 窄边 narrow side-5mm

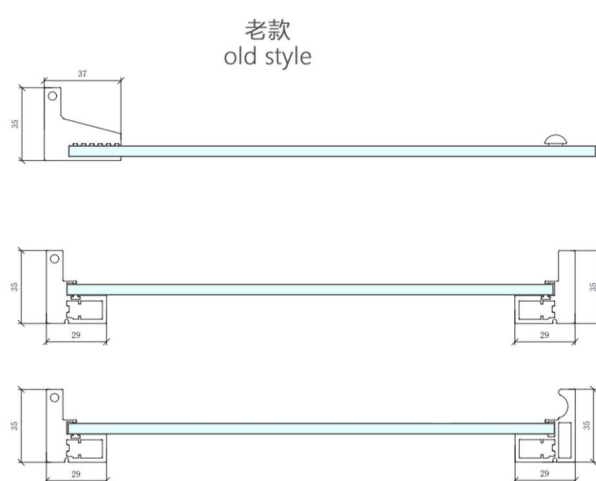
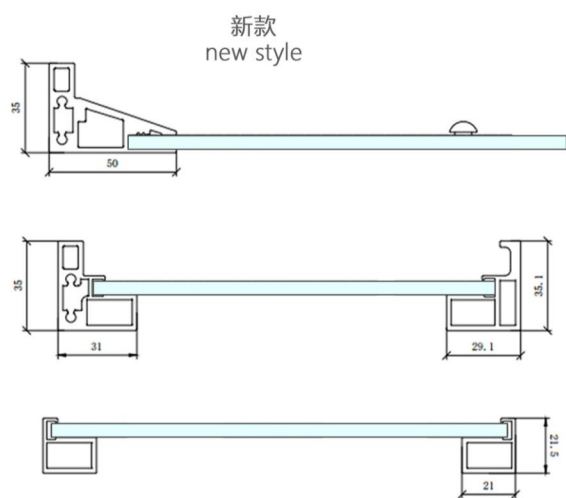

NEEDLE TYPE SINGLE BORDER 针式单边框

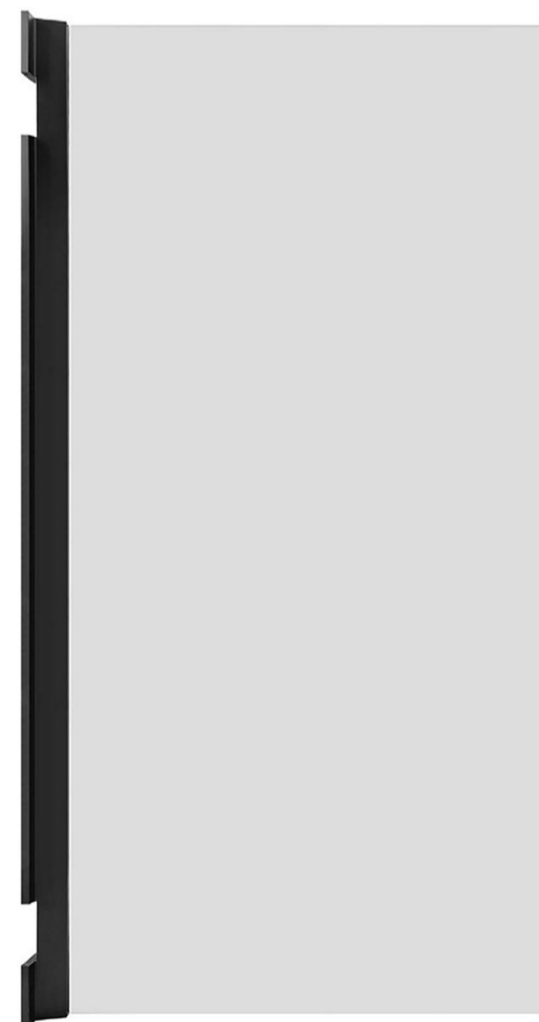

铰链 / Hinge: 针式铰链 Hinge pin type

玻璃颜色 / Glass color: 欧洲灰 / 金茶 / 灰茶 / 白玻 / 超白玻 / 黑玻 / 长虹玻璃 / 大灯芯 / 小灯芯
European grey / Golden Tea / Grey Tea / white glass / super white glass / Black Glass / Changhong glass / headlamp wick / small wick

拉手长度 / Handle length: 玻璃上安装圆头拉手

尺寸限定 / Size limit: (200mm ≤ W ≤ 900mm) (200mm ≤ H ≤ 2850mm)

玻璃减尺 / Glass reduction: 宽边 -12mm, 窄边不减

新款
new style



老款
old style



KNITTED HINGED DOOR PANEL PROFILE
针织铰链门板型材



CWJ-6D-27	CWJ-6D-163	CWJ-6D-162	CWJ-6D-103
KG/M: 0.8kg/m	KG/M: 1.16kg/m	KG/M: 1.13kg/m	KG/M: 1.67kg/m
CWJ-6D-164	KL-QLJ-K001	KL-QLJ-K002	KL-QLJ-K003
KG/M: 0.41kg/m	KG/M: 1.31kg/m	KG/M: 0.89kg/m	KG/M: 0.75kg/m

HEAVEN AND EARTH HINGED DOOR PANEL PROFILE
天地铰链门板型材



CWJ-6D-118	KL-CWJ-6D-154	CWJ-6D-123	CWJ-6D-271
KG/M: 0.81kg/m	KG/M: 0.57kg/m	KG/M: 0.59kg/m	KG/M: 0.44kg/m
CWJ-6D-119	KL-CWJ-6D-153	CWJ-6D-122	CWJ-6D-272
KG/M: 1.08kg/m	KG/M: 0.72kg/m	KG/M: 0.79kg/m	KG/M: 0.66kg/m

CWJ-6D-221 KG/M: 0.83kg/m	CWJ-6D-220 KG/M: 0.65kg/m	CWJ-6D-146 KG/M: 0.65kg/m	CWJ-6D-221 KG/M: 0.58kg/m
CWJ-6D-222 KG/M: 1.13kg/m	CWJ-6D-219 KG/M: 0.85kg/m	CWJ-6D-147 KG/M: 0.95kg/m	CWJ-6D-126 KG/M: 1.12kg/m
WAB-1002 KG/M: 0.62kg/m	WAB-1001 KG/M: 0.42kg/m	WAB-1003 KG/M: 0.09kg/m	LJ-10070 KG/M: 0.895kg/m
LJ-10066 KG/M: 0.624kg/m	LJ-10069 KG/M: 0.733kg/m	LJ-10067 KG/M: 0.371kg/m	LJ-10068 KG/M: 1.243kg/m
LJ-10065 KG/M: 1.029kg/m	LJ-10063 KG/M: 0.457kg/m	LJ-10064 KG/M: 0.699kg/m	

ONE WORD HINGE 20 DOOR PROFILE
一字铰链20门板型材



CWJ-6D-141 KG/M: 0.32kg/m	CWJ-6D-254 KG/M: 0.49kg/m	CWJ-6D-253 KG/M: 0.54kg/m	CWJ-6D-142 KG/M: 0.49kg/m
CWJ-6D-165 KG/M: 0.61kg/m	CWJ-6D-27 KG/M: 0.58kg/m	CWJ-6D-164 KG/M: 0.41kg/m	YY-276 KG/M: 0.248kg/m

WIDE EDGE DOOR PROFILE/ROUND CUP HINGE
宽边门板型材/圆杯铰链



<p>CWJ-6D-190</p> <p>KG/M: 0.65kg/m</p>	<p>CWJ-6D-101</p> <p>KG/M: 0.669kg/m</p>	<p>CWJ-6D-120</p> <p>KG/M: 0.53kg/m</p>	<p>CWJ-6D-188</p> <p>KG/M: 0.86kg/m</p>
<p>CWJ-6D-191</p> <p>KG/M: 0.36kg/m</p>	<p>CWJ-6D-102</p> <p>KG/M: 0.38kg/m</p>	<p>CWJ-6D-121</p> <p>KG/M: 0.29kg/m</p>	<p>CWJ-6D-120</p> <p>KG/M: 0.84kg/m</p>
<p>YY-170</p> <p>KG/M: 0.564kg/m</p>	<p>YY-222</p> <p>KG/M: 0.494kg/m</p>	<p>AA-SO1-652</p> <p>KG/M: 0.64kg/m</p>	<p>WAB4501</p> <p>KG/M: 0.39kg/m</p>
<p>WAB4503</p> <p>KG/M: 0.35kg/m</p>	<p>WAB4502</p> <p>KG/M: 0.425kg/m</p>	<p>BLN-001</p> <p>T: 1.2mm</p>	<p>BLN-002</p> <p>T: 1.2mm</p>
<p>BLN-003</p> <p>T: 1.5mm</p>	<p>BLN-004</p> <p>T: 6.0mm</p>		

WIDE EDGE DOOR PROFILE/ROUND CUP HINGE
宽边门板型材/圆杯铰链



KX-BZ01 KG/M:0.765kg/m	KX-BZ02 KG/M:0.763kg/m	KX-BZ03 KG/M:0.273kg/m	YYL-3638 KG/M: 0.35kg/m
AA-SO1-648 KG/M: 0.69kg/m	AA-SO1-668 KG/M: 0.55kg/m	AA-SO1-653 KG/M: 0.51kg/m	RJ-1071 KG/M: 0.657kg/m
RJ-1069 KG/M: 0.405kg/m	RJ-1070 KG/M: 0.539kg/m	CWJ-172 KG/M: 0.54kg/m	CWJ-173 KG/M: 0.80kg/m
CWJ-6D-172 45 door frame	CWJ-6D-173 45 door frame	CWJ-6D-260 50 box(with light)	CWJ-6D-261 50 box(with light)
YY-184 KG/M: 0.356kg/m	YY-370 KG/M: 0.358kg/m	YY-468 KG/M: 0.459kg/m	

WARDROBE SLIDING DOOR SERIES

衣柜移门系列

高级定制，用心打造。
ADVANCED CUSTOMIZATION, BUILT WITH HEART.



静音推拉设计

轻奢时尚节省空间自由移动，推拉方便。

Light luxury fashion space saving free movement, push and pull convenient, is the Gospel of small and medium-sized bedrooms.

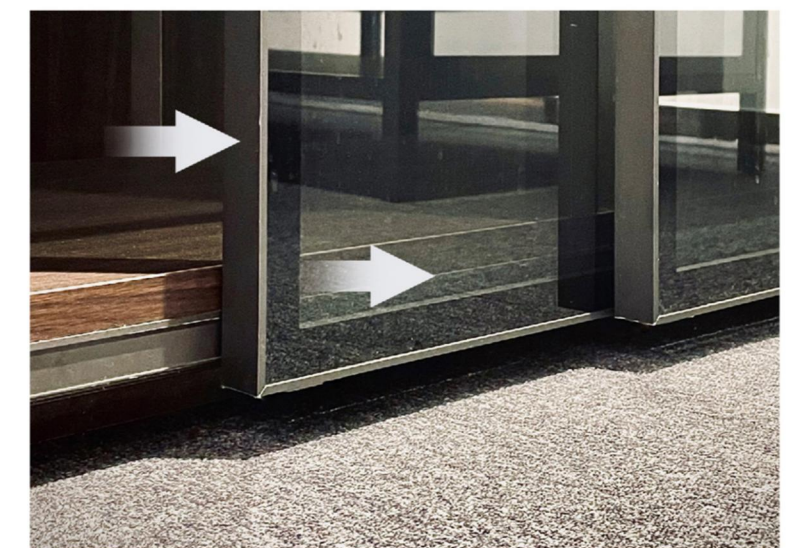

衣柜移门系列 WARDROBE SLIDING DOOR SERIES

A 款

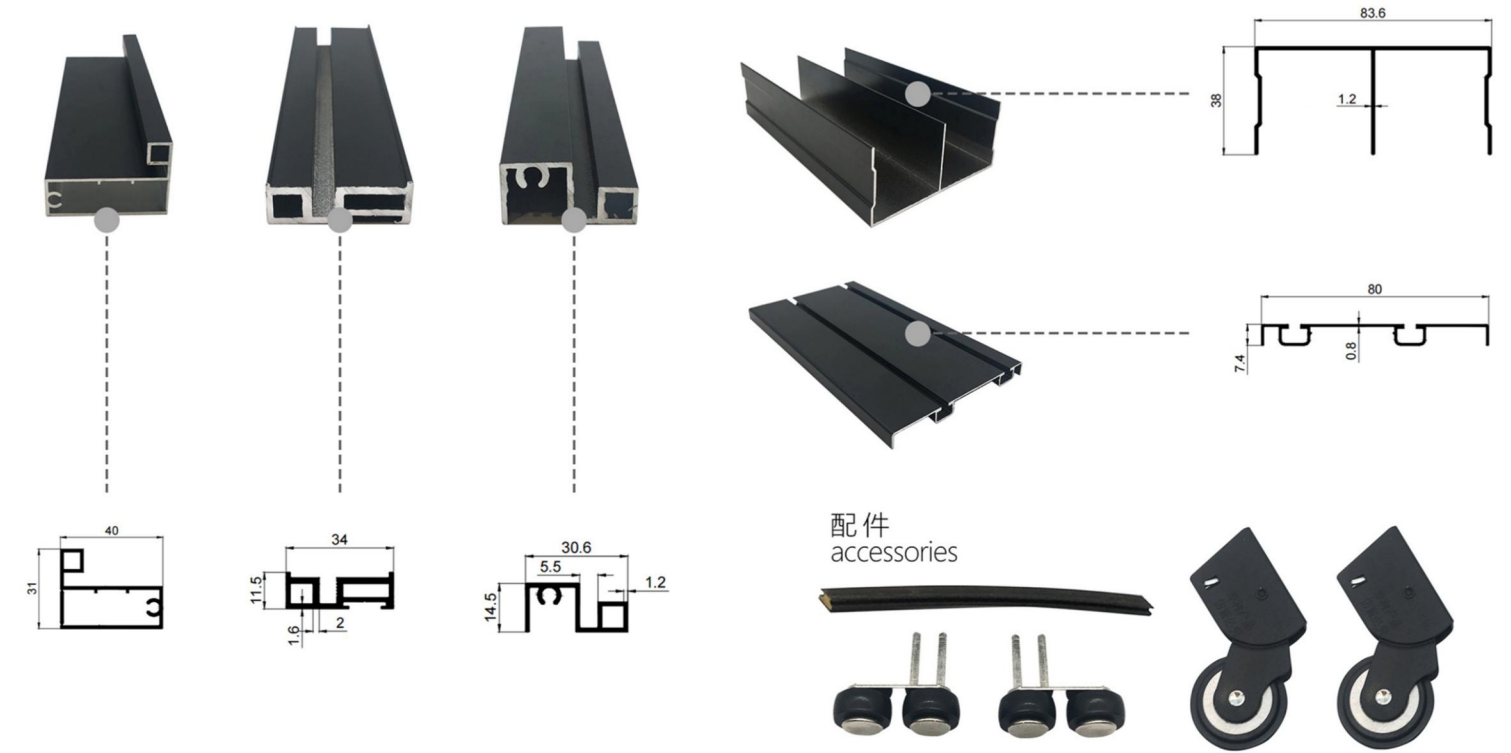

B 款

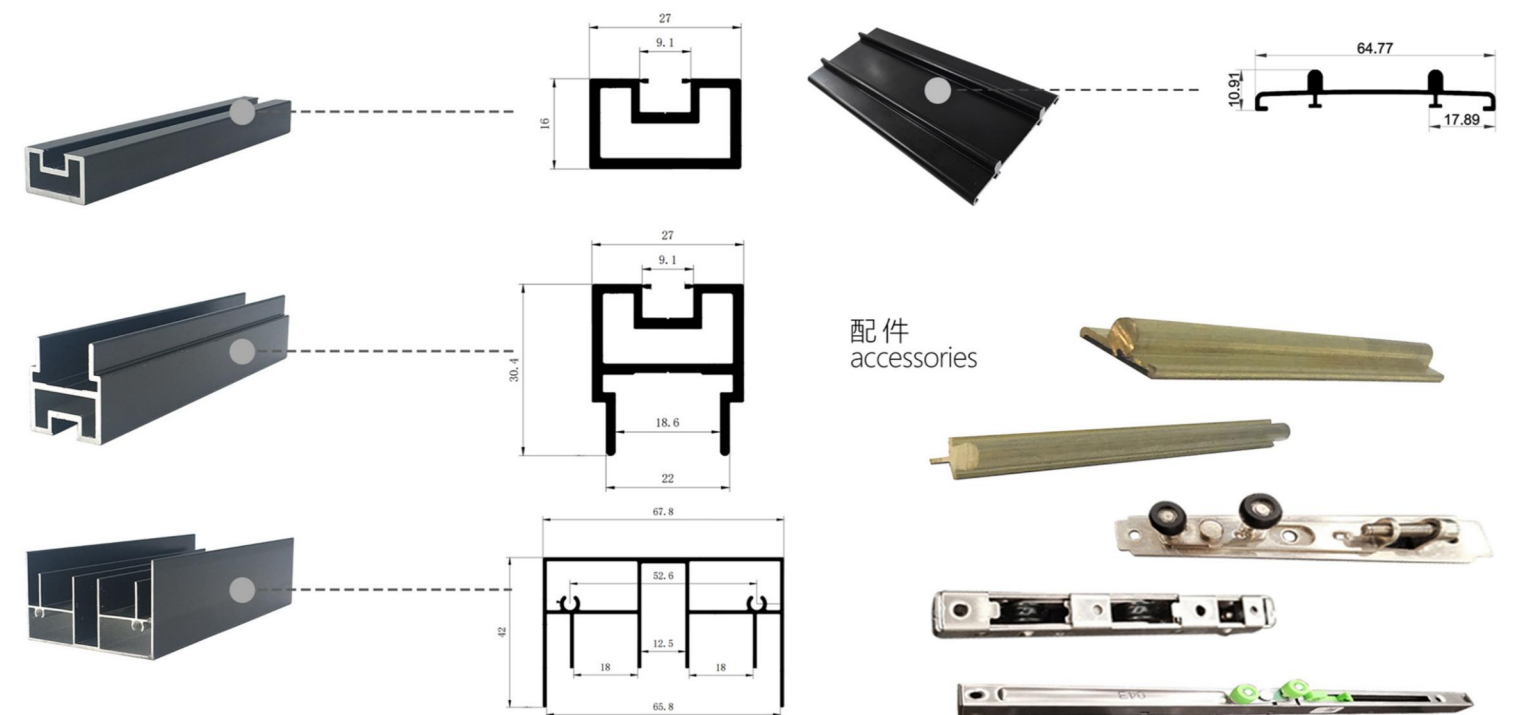

衣柜移门系列 WARDROBE SLIDING DOOR SERIES

C 款

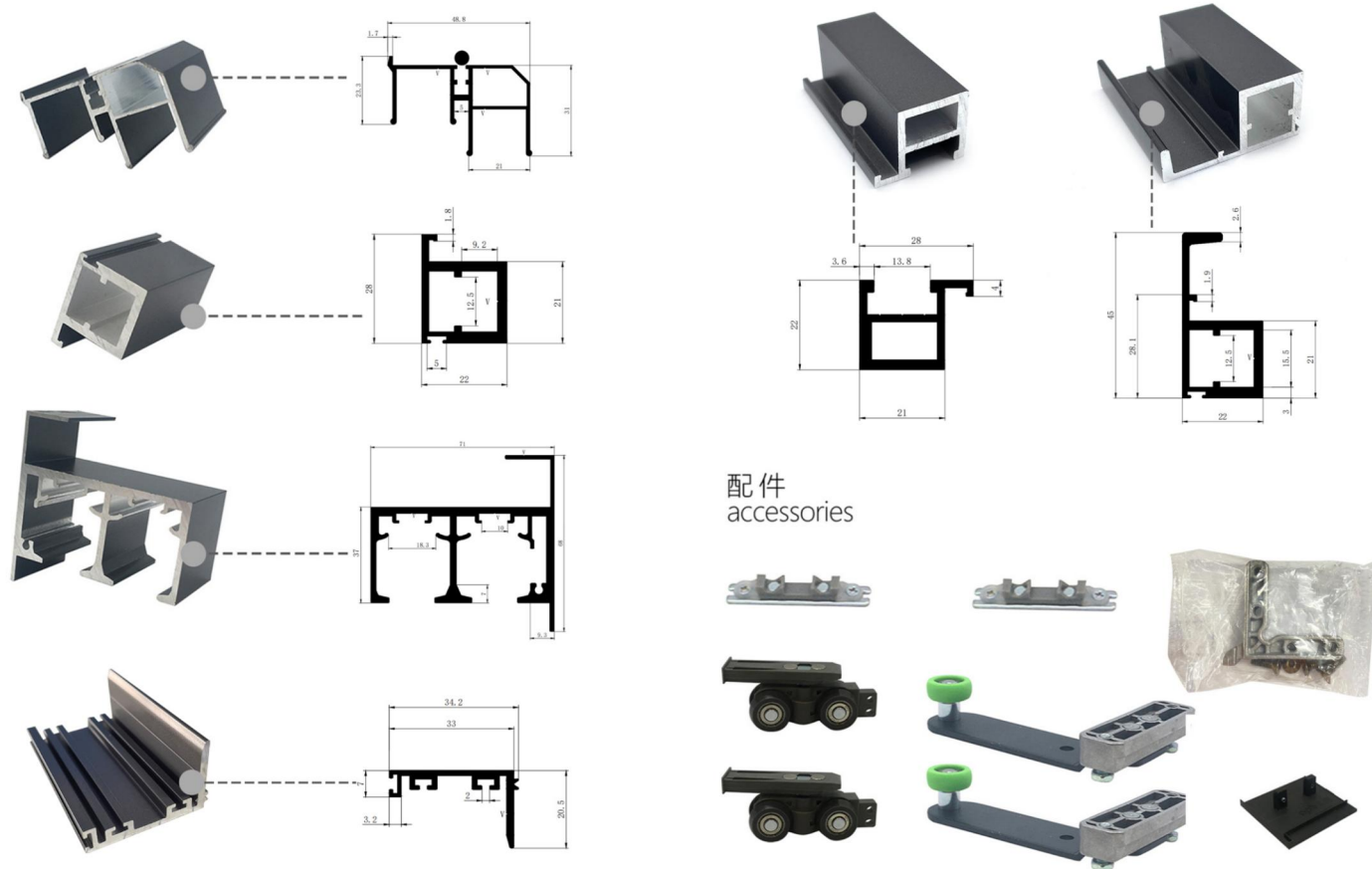

WARDROBE DOOR PANEL PROFILE A TYPE 衣柜移门板型材 A款

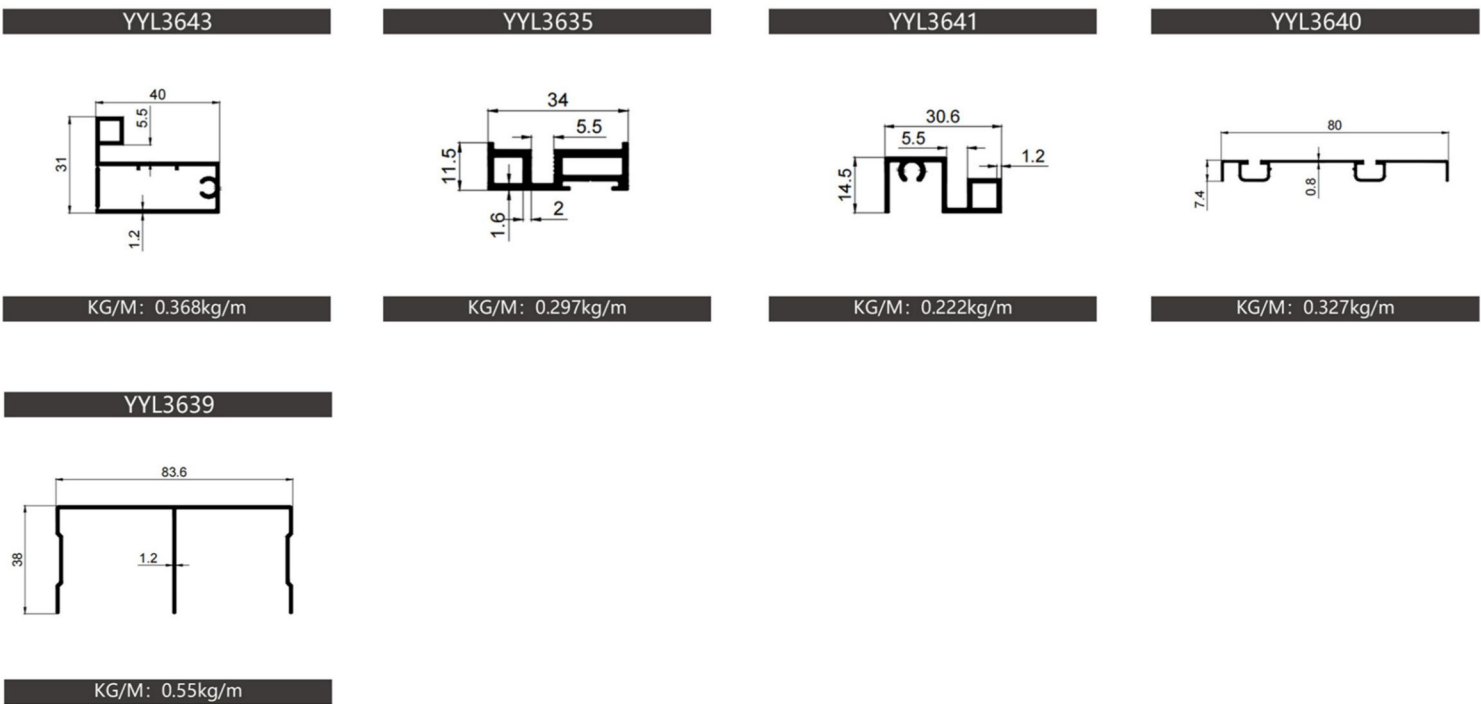

WARDROBE DOOR PANEL PROFILE B TYPE 衣柜移门板型材 B款

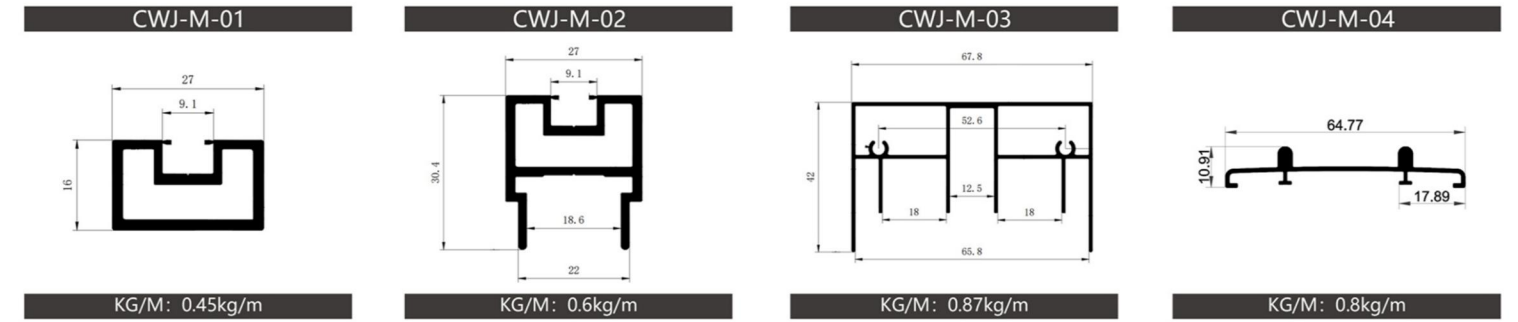

WARDROBE DOOR PANEL PROFILE B TYPE 衣柜移门板型材 C款

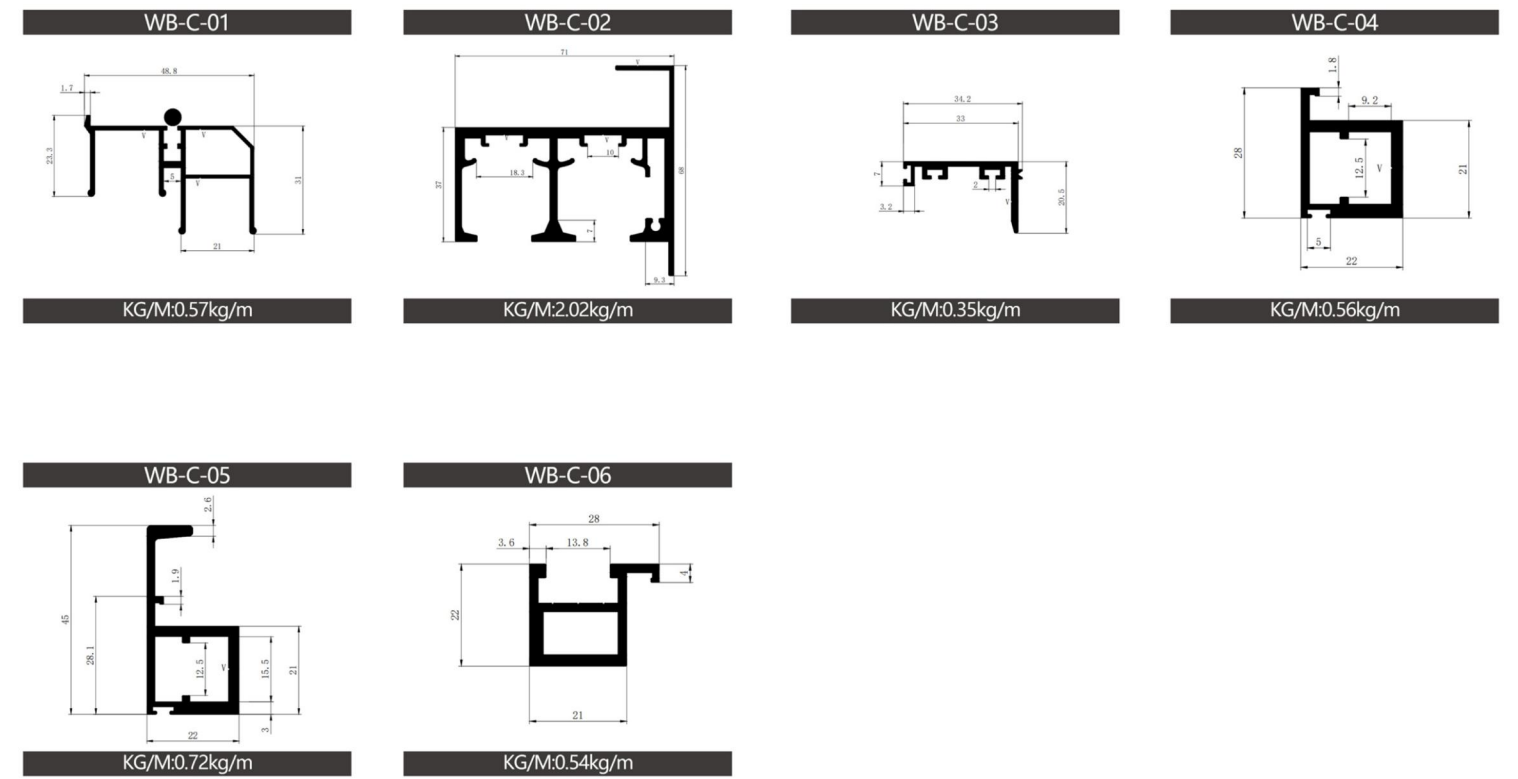



20门板 20 DOOR PANELS

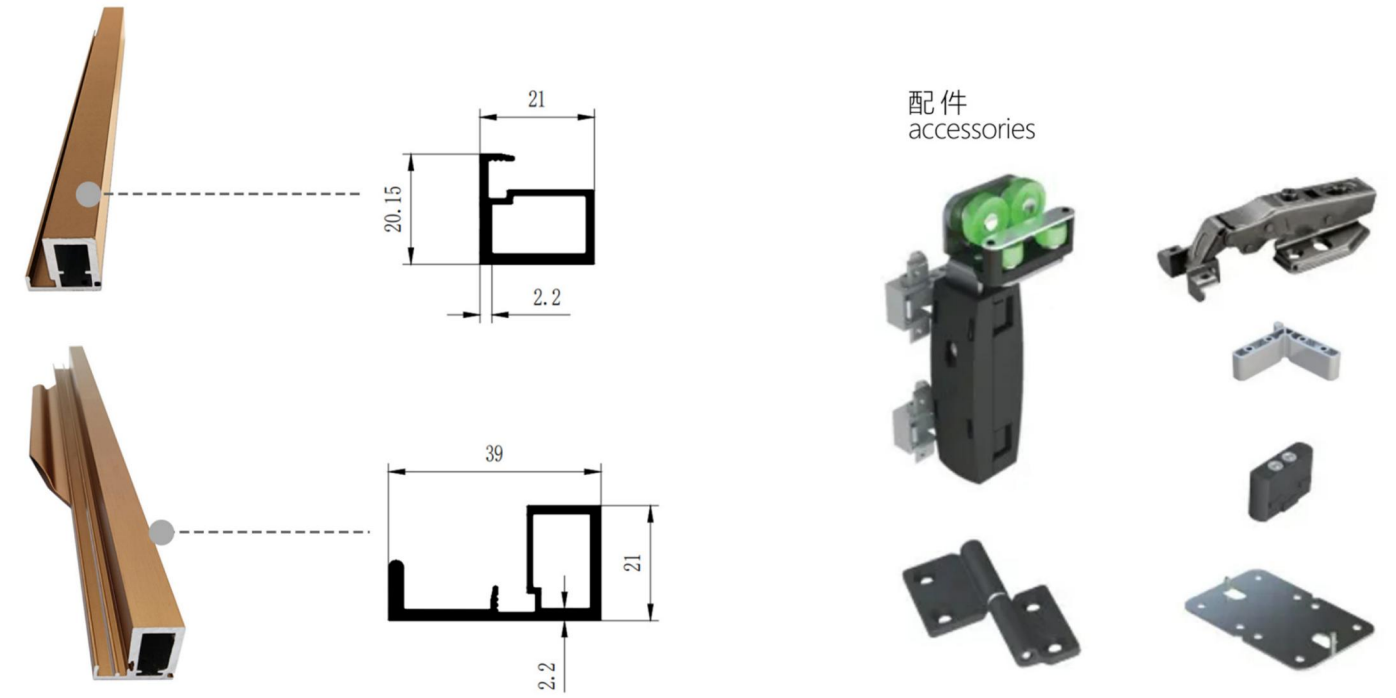

WARDROBE FOLDING DOOR PANEL PROFILE
衣柜折叠门板型材

XJA365	CWJ-6D-141	CWJ-6D-142
KG/M: 0.528kg/m	KG/M: 0.32kg/m	KG/M: 0.49kg/m

LAMINATE SERIES

层板系列

追求细节，直至苛求。

THE PURSUIT OF DETAILS, UNTIL DEMANDING.

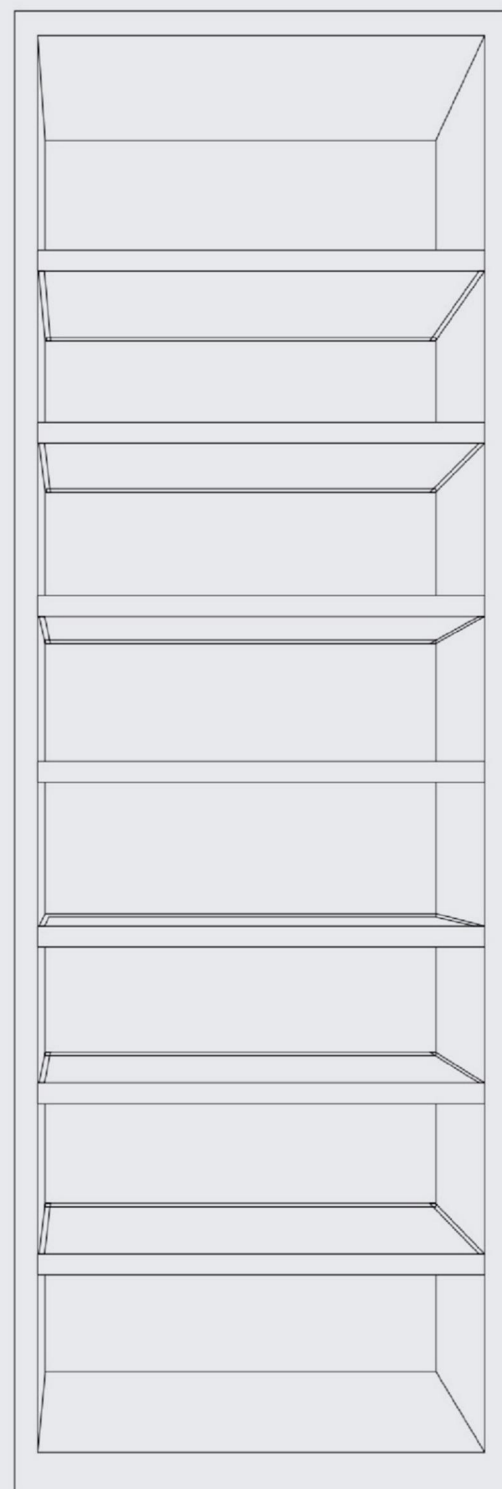

细节是整体美感的灵魂，细节的合理用度，创造组合就是美好产品本身的观点，细节见证品质，有细节的空间才是唯美的。充满活力的设计，独具个性与品味，体现着生活的抒情与写意，散发与之俱来的魅力使抒情的空间弥漫个性又奔放气氛。

Details are the soul of the overall beauty, the reasonable use of details, the creation of a combination is the point of view of the beautiful product itself, details witness quality, and the space with details is beautiful. The vibrant design, unique personality and taste, reflects the lyrical and freehand life, and exudes the inherent charm to make the lyrical space filled with personality and unrestrained atmosphere.

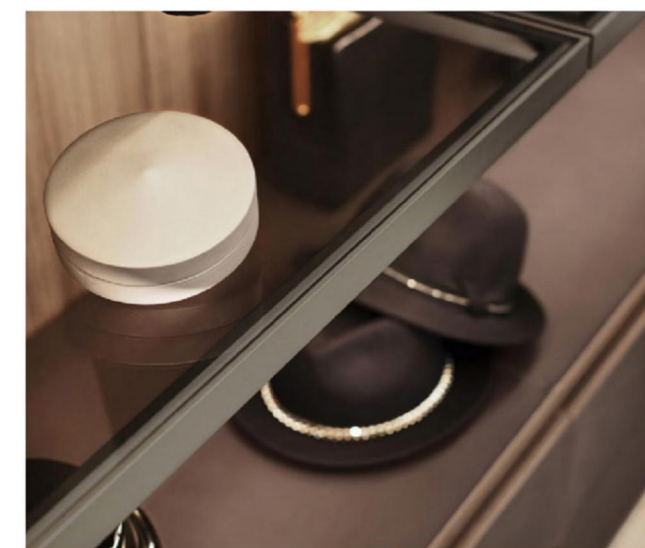

36mm 层板 36MM LAMINATE



CWJ-6D-135 层板左右后 (不带灯带) Laminates left and right rear (without light strip)
 CWJ-6D-136 层板前 (带灯带) Laminates (with light strip)

门型编号 / Door type No: CWJ-6D-135 + CWJ-6D-136

玻璃颜色 / Glass color: 欧洲灰 / 金茶 / 灰茶 / 白玻 / 超白玻 / 黑玻 / 长虹玻璃 / 大灯芯 / 小灯芯
 European grey / Golden Tea / Grey Tea / white glass / super white glass / Black Glass / Changhong glass / headlamp wick / small wick

挂板孔位置 / Hanging plate hole: 玻璃柜 (前 16mm+后 13mm) / 板式柜 (前 40mm+40mm)

出线方向 / Outgoing direction: 左后 / 右后

玻璃厚度 / Glass thickness: 5mm

玻璃减尺 / Glass reduction: -5mm



22mm 层板 22MM LAMINATE



CWJ-6D-205 层板前 (带硅胶灯带) Front of the laminate (with silicone light strip)
 CWJ-6D-206 层板左右后 (不带灯带) Laminates left and right rear (without light strip)

门型编号 / Door type No: CWJ-6D-205 + CWJ-6D-206

玻璃颜色 / Glass color: 欧洲灰 / 金茶 / 灰茶 / 白玻 / 超白玻 / 黑玻 / 长虹玻璃 / 大灯芯 / 小灯芯
 European grey / Golden Tea / Grey Tea / white glass / super white glass / Black Glass / Changhong glass / headlamp wick / small wick

挂板孔位置 / Hanging plate hole: 玻璃柜 (前 16mm+后 13mm) / 板式柜 (前 40mm+40mm)

出线方向 / Outgoing direction: 左后 / 右后

玻璃厚度 / Glass thickness: 5mm

玻璃减尺 / Glass reduction: 精磨 Fine grinding-6mm



25mm 层板 25MM LAMINATE



CWJ-6D-186 层板前 (带硅胶灯带) Front of the laminate (with silicone light strip)
 CWJ-6D-187 层板左右后 (不带灯带) Laminates left and right rear (without light strip)

门型编号 / Door type No: CWJ-6D-186 + CWJ-6D-187

玻璃颜色 / Glass color: 欧洲灰 / 金茶 / 灰茶 / 白玻 / 超白玻 / 黑玻 / 长虹玻璃 / 大灯芯 / 小灯芯
 European grey / Golden Tea / Grey Tea / white glass / super white glass / Black Glass / Changhong glass / headlamp wick / small wick

挂板孔位置 / Hanging plate hole: 玻璃柜 (前 16mm+后 13mm) / 板式柜 (前 40mm+40mm)

出线方向 / Outgoing direction: 左后 / 右后

玻璃厚度 / Glass thickness: 5mm

玻璃减尺 / Glass reduction: -7mm



天地亮双玻璃层板 TIANDILIANG DOUBLE GLASS LAMINATE

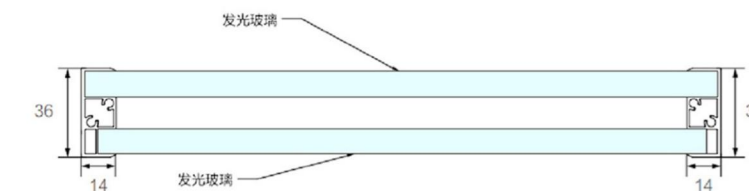

CWJ-6D-204 层板 (带灯带) Laminates (with light strip)
 CWJ-6D-204 层板 (带灯带) Laminates (with light strip)

门型编号 / Door type No: CWJ-6D-204

玻璃颜色 / Glass color: 欧洲灰 / 金茶 / 灰茶 / 白玻 / 超白玻 / 黑玻 / 长虹玻璃 / 大灯芯 / 小灯芯
 European grey / Golden Tea / Grey Tea / white glass / super white glass / Black Glass / Changhong glass / headlamp wick / small wick

挂板孔位置 / Hanging plate hole: 玻璃柜 (前 16mm+后 13mm) / 板式柜 (前 40mm+40mm)

出线方向 / Outgoing direction: 左后 / 右后

玻璃厚度 / Glass thickness: 8mm

玻璃减尺 / Glass reduction: 上方 Upper: -4mm, 下方 Below: -15mm



18mm 层板 18MM LAMINATE



CWJ-6D-213
层板前 (带硅胶灯带)
Front of the laminate
(with silicone light strip)

CWJ-6D-215 CWJ-6D-214
层板左右后 (不带灯带)
Laminate left and right rear (without light strip)

门型编号 / Door type No: CWJ-6D-213 + CWJ-6D-215 + CWJ-6D-214

玻璃颜色 / Glass color: 欧洲灰 / 金茶 / 灰茶 / 白玻 / 超白玻 / 黑玻 / 长虹玻璃 / 大灯芯 / 小灯芯
European grey / Golden Tea / Grey Tea / white glass / super white glass / Black Glass / Changhong glass /
headlamp wick / small wick

挂板孔位置 / Hanging plate hole: 玻璃柜 (前 16mm+后 13mm) / 板式柜 (前 40mm+40mm)

出线方向 / Outgoing direction: 左后 / 右后

玻璃厚度 / Glass thickness: 5mm

玻璃减尺 / Glass reduction: -3mm



36mm 四面发光硅胶层板 36MM FOUR SIDE LUMINESCENT SILICA GEL LAMINATE



CWJ-6D-227
层板 (带硅胶灯带)
Laminate (with silicone light strip)

CWJ-6D-227
层板 (带灯带)
Laminate (with light strip)

门型编号 / Door type No: CWJ-6D-227

玻璃颜色 / Glass color: 欧洲灰 / 金茶 / 灰茶 / 白玻 / 超白玻 / 黑玻 / 长虹玻璃 / 大灯芯 / 小灯芯
European grey / Golden Tea / Grey Tea / white glass / super white glass / Black Glass / Changhong glass /
headlamp wick / small wick

挂板孔位置 / Hanging plate hole: 玻璃柜 (前 16mm+后 13mm) / 板式柜 (前 40mm+40mm)

出线方向 / Outgoing direction: 左后 / 右后

玻璃厚度 / Glass thickness: 5mm

玻璃减尺 / Glass reduction: -5mm



ECOGATE SERIES

生态门系列

极简如此·顺畅如丝。
IT'S SO SIMPLE AND SMOOTH.

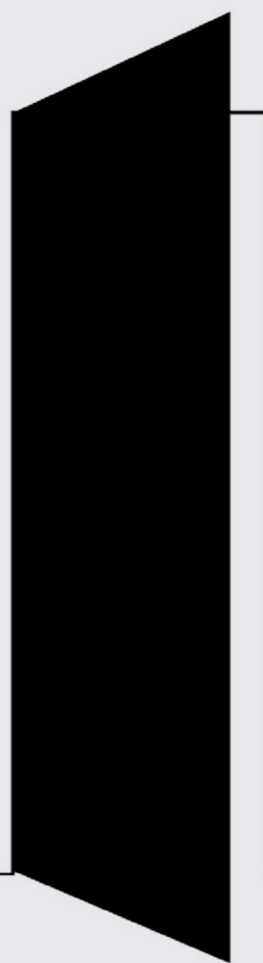

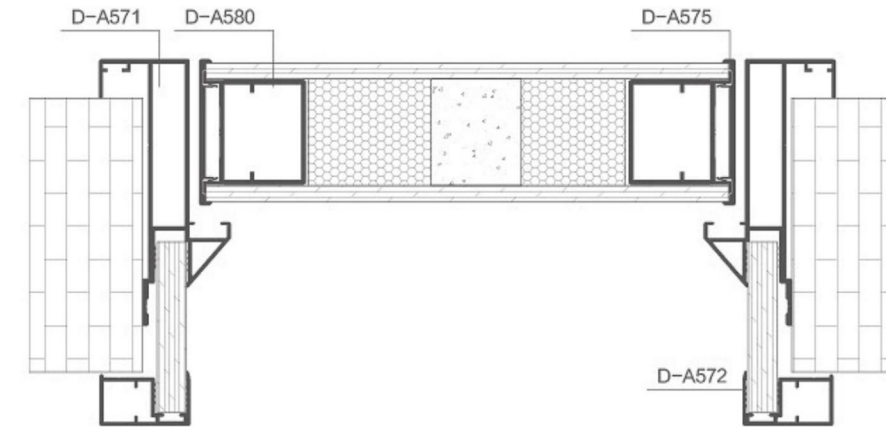

五金配置: 四孔明合页, 精铸钢合页, 磁吸锁具。



<p>D-A571 Main frame</p> <p>主框 T: 1.4mm G: 0.901kg/m</p>	<p>D-A572 Sub-frame</p> <p>副框 T: 1.2mm G: 0.312kg/m</p>	<p>D-A575B collision cover</p> <p>门楣副框 T: 2.0mm G: 0.26kg/m</p>	<p>D-A580 Support pole</p> <p>龙骨 T: 1.4mm G: 0.455kg/m</p>
<p>D-A585 Damp-proof strips</p> <p>防潮条 T: 1.2mm G: 0.228kg/m</p>	<p>D-A470H cap</p> <p>门楣挡条 T: 1.0mm G: 0.591kg/m</p>	<p>D-A613 Door barrier</p> <p>子母门收口 T: 1.2mm G: 0.235kg/m</p>	<p>D-A612 Sub-frame</p> <p>扣板 T: 1.2mm G: 0.319kg/m</p>

50 NEW SYSTEM(GREY LOT VERSION) 50新系统(批灰款)

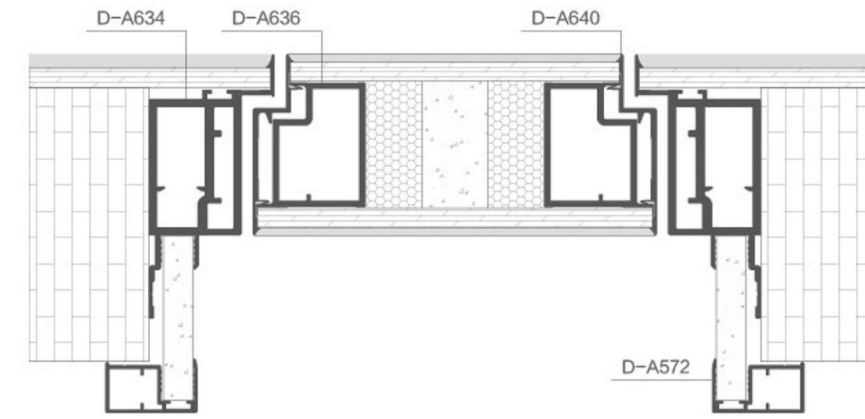

五金配置: 三维合页, 磁吸锁具。



D-A634 Main frame

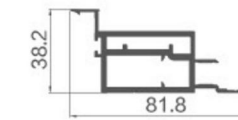

主框

T: 3.0mm G: 1.443kg/m

D-A572 Sub-frame



副框

T: 1.2mm G: 0.505kg/m

D-A636 Support pole



龙骨

T: 2.0mm G: 0.72kg/m

D-A640 Cover

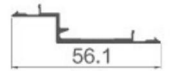

盖板

T: 1.4mm G: 0.289kg/m

D-A647 Lower cross cover

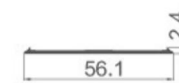

下横盖板

T: 1.4mm G: 0.202kg/m

D-A596 lower horizontal

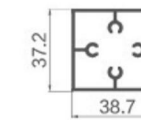

下横

T: 1.5mm G: 0.826kg/m

D-A614 F strip

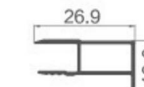

F条

T: 1.0mm G: 0.195kg/m

D-A470H gusset

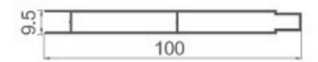

扣板

T: 1.0mm G: 0.591kg/m

D-A585 Moisture-proof strip

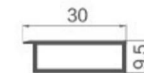

T: 1.2mm G: 0.228kg/m



50 NEW SYSTEM (FLAT OUTSIDE, OPEN INSIDE 5MM PANELS) 50新系统(外平内开5mm板)

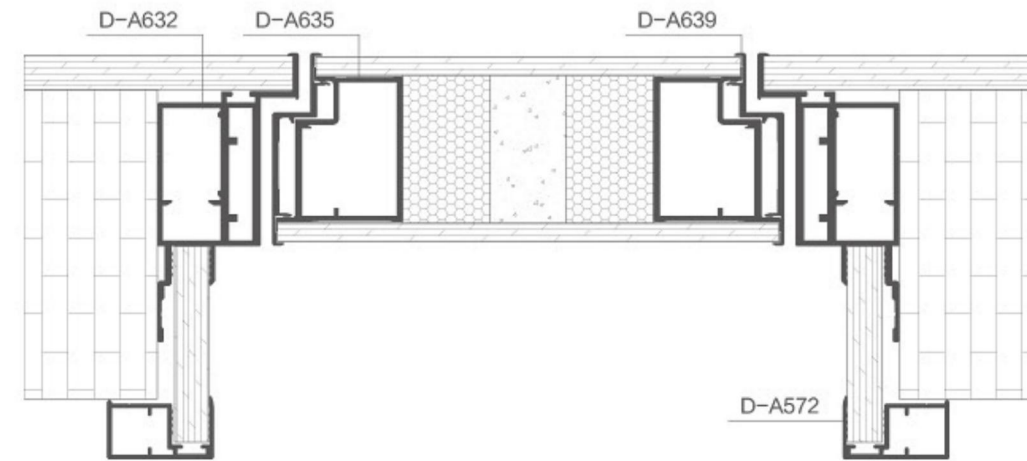

五金配置: 常规三维合页, 四孔明合页, 磁吸锁具。

<p>D-A632 Main frame</p> <p>主框 T: 1.4mm G: 1.102kg/m</p>	<p>D-A572 Sub-frame</p> <p>副框 T: 1.2mm G: 0.312kg/m</p>	<p>D-A635 Support pole</p> <p>龙骨 T: 1.6mm G: 5.83kg/m</p>	<p>D-A639 Cover</p> <p>盖板 T: 2.0mm G: 0.302kg/m</p>
<p>D-A595 Lower cross cover</p> <p>下横盖板 T: 1.6mm G: 0.213kg/m</p>	<p>D-A596 lower horizontal</p> <p>下横 T: 1.5mm G: 0.826kg/m</p>	<p>D-A614 F strip</p> <p>F条 T: 1.0mm G: 0.195kg/m</p>	<p>D-A470H gusset</p> <p>扣板 T: 1.0mm G: 0.591kg/m</p>
<p>D-A585 Moisture-proof strip</p> <p>T: 1.2mm G: 0.228kg/m</p>			

HANDLE PROFILE

拉手型材系列

高级定制，用心打造。
ADVANCED CUSTOMIZATION, BUILT WITH HEART.

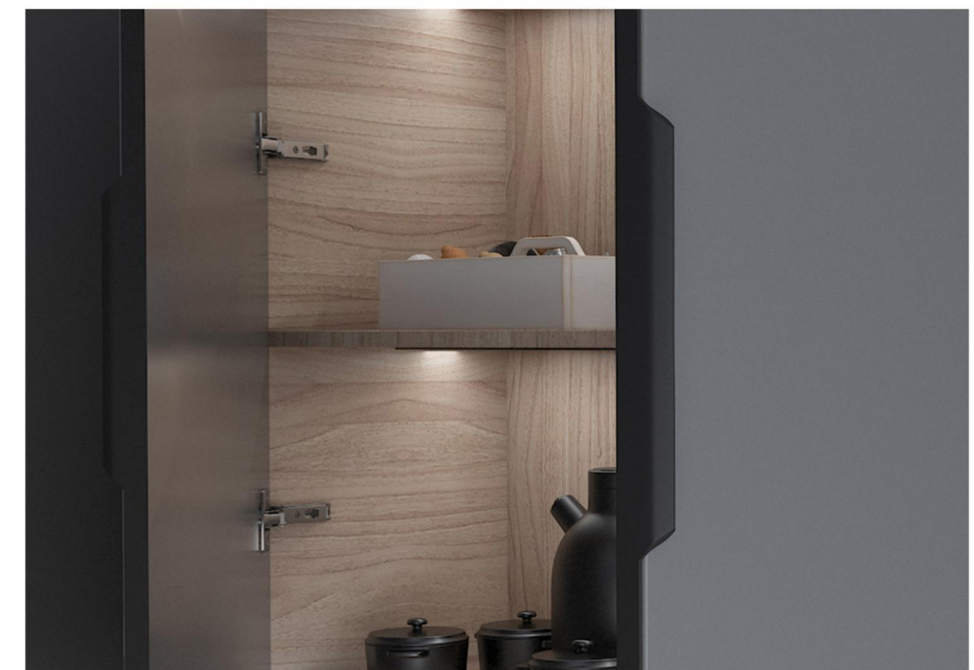
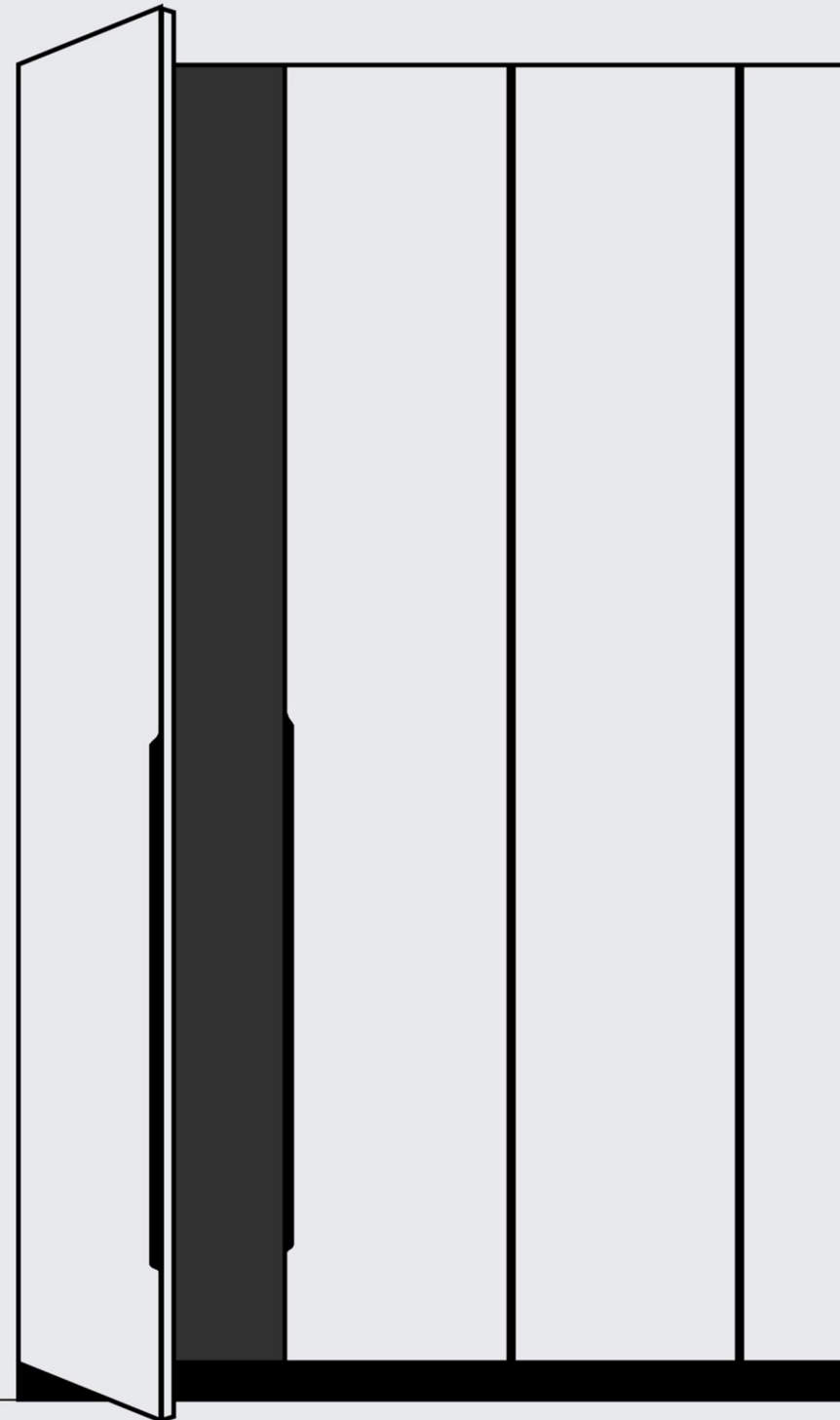

铣型封边拉手系列 MILLING EDGE BANDING HANDLE SERIES



G-A47 (F style 2.0 thick)
G-1322 (F style 2.5 thick)

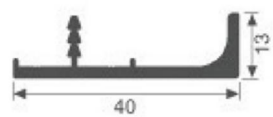

Material: aluminum alloy
Color: matte gold, matte black, brushed bronze, light gold, light, gentleman gray
Specifications: 300, 350, 400, 450, 500, 600, 800, 1000, 1500.

G-032 (thumb 2.0 thick)
G-1321 (thumb 2.5 thick)

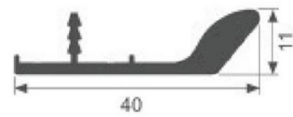

G-069

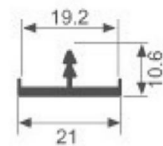

MILLING EDGE BANDING HANDLE SERIES 铣型封边拉手系列



G-1305(red flag)

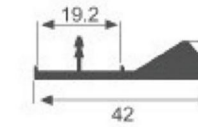

G-1304 (Cabernet)

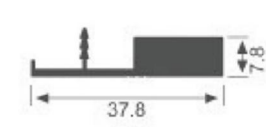

Material: aluminum alloy
Color: matte black, matte gold, light gold, light, gentleman gray
Specifications: 300, 350, 400, 450, 500, 600, 800, 1000, 1500, 1800, 2100, 2440, 2780



G-046G(Apple model)

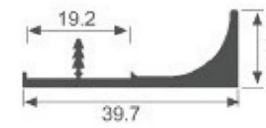

Material: aluminum alloy
Color: matte black, matte gold, light gold, light, gentleman gray
Specifications: 300, 350, 400, 450, 500, 600, 800, 1000, 1500, 1800, 2100, 2440, 2780



G-2019(red flag with plug)



Material: aluminum alloy
Color: matte black, brushed bronze, brushed gentleman gray
Specifications: 300, 350, 400, 450, 500, 600, 800, 1000, 1500, 1800, 2100, 2440, 2780



G-2056(Thumb type with plug)



Material: aluminum alloy
Color: matte black, brushed bronze, brushed gentleman gray
Specifications: 300, 350, 400, 450, 500, 600, 800, 1000, 1500, 1800, 2100, 2440, 2780



G-2057(with plug F type)

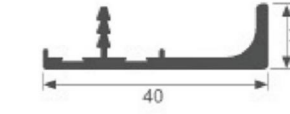

Material: aluminum alloy
Color: matte black, brushed bronze, brushed gentleman gray
Specifications: 300, 350, 400, 450, 500, 600, 800, 1000, 1500, 1800, 2100, 2440, 2780

铣型封边拉手系列 MILLING EDGE BANDING HANDLE SERIES



G-1324(M style)

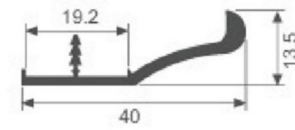

Material: silver alloy
 Color: matte black, matte gold, light gold, light, gentleman gray
 Specifications: 300, 350, 400, 450, 500, 600, 800, 1000, 1500, 1800, 2100, 2440, 2780



G-1303(hollow section)

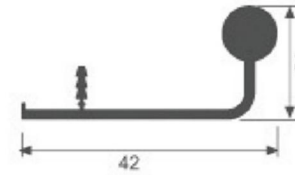

Material: silver alloy
 Color: matte black, matte gold, light gold, light, gentleman gray
 Specifications: 300, 350, 400, 450, 500, 600, 800, 1000, 1500, 1800, 2100, 2440, 2780



G-9073(small smiling face)



Material: aluminum alloy
 Color: Matte Black, Matte Gold, Light Gold, Glossy, Kunz Gray
 Specifications: 300, 350, 400, 450, 500, 600, 800, 1000, 1500, 1800, 2100, 2440, 2780



G-1325(BMW style)

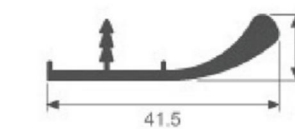

Material: aluminum alloy
 Color: Matte Black, Matte Gold, Light Gold, Glossy, Kunz Gray
 Specifications: 300, 350, 400, 450, 500, 600, 800, 1000, 1500, 1800, 2100, 2440, 2780

MILLING EDGE BANDING HANDLE SERIES 铣型封边拉手系列

G-2068(Slot-Free Thumb Handle)



Material: aluminum alloy
 Color: matte black, matte gold, brushed bronze
 Specifications: 300, 400, 450, 500, 600, 800, 1000, 1500, 2440, 2780

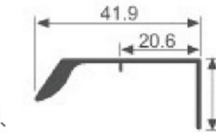

G-2067(Slot-Free F Type Handle)



Material: aluminum alloy
 Color: matte black, matte gold, brushed bronze
 Specifications: 300, 400, 450, 500, 600, 800, 1000, 1500, 2440, 2780

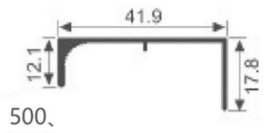

G-9512(whole body lazy handle)



Material: aluminum alloy
 Color: matte black, brushed bronze
 Specifications: 150, 200, 1000, 1100, 2800

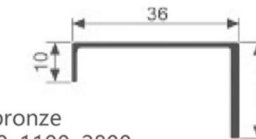

G-9512(whole body lazy handle)



Material: aluminum alloy
 Color: matte black, brushed bronze
 Specifications: 150, 200, 1000, 1100, 2800

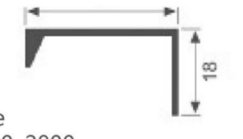

G-9512(whole body lazy handle)



Material: aluminum alloy
 Color: matte black, brushed bronze
 Specifications: 150, 200, 1000, 1100, 2800

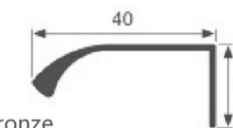

铣型封边拉手系列 MILLING EDGE BANDING HANDLE SERIES



G-9230(Leather thumb handle)



Material: aluminum alloy
 Color: matte black, brushed bronze, gentleman gray, matte gold
 Specifications: 400, 800, 1800, 2100, 2440, 2780



G-9229(Leather F Type Handle)

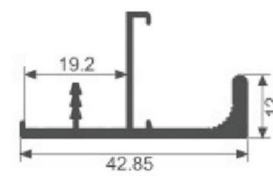

Material: aluminum alloy
 Color: matte black, brushed bronze, gentleman gray, matte gold
 Specifications: 400, 800, 1800, 2100, 2440, 2780

MILLING EDGE BANDING HANDLE SERIES 铣型封边拉手系列



G-9231(hollow leather handle)

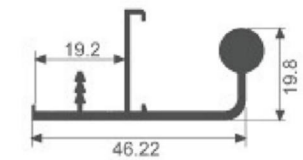

Material: aluminum alloy
 Color: matte gold, matte black, gentleman gray, Weifa gold, brushed bronze
 Specifications: 400, 800, 1800, 2100, 2440, 2780



铣型封边拉手系列 MILLING EDGE BANDING HANDLE SERIES



G-9230(Leather thumb handle)



Material: aluminum alloy
 Color: matte black, brushed bronze, gentleman gray, matte gold
 Specifications: 400, 800, 1800, 2100, 2440, 2780



G-9229(Leather F Type Handle)

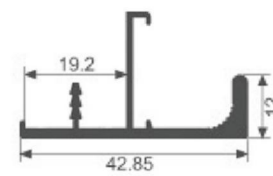

Material: aluminum alloy
 Color: matte black, brushed bronze, gentleman gray, matte gold
 Specifications: 400, 800, 1800, 2100, 2440, 2780

MILLING EDGE BANDING HANDLE SERIES 铣型封边拉手系列



G-9231(hollow leather handle)

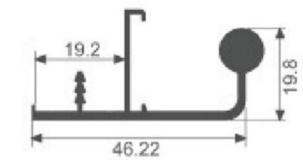

Material: aluminum alloy
 Color: matte gold, matte black, gentleman gray, Weifa gold, brushed bronze
 Specifications: 400, 800, 1800, 2100, 2440, 2780



G-TYPE HANDLE PROFILE

G型拉手型材

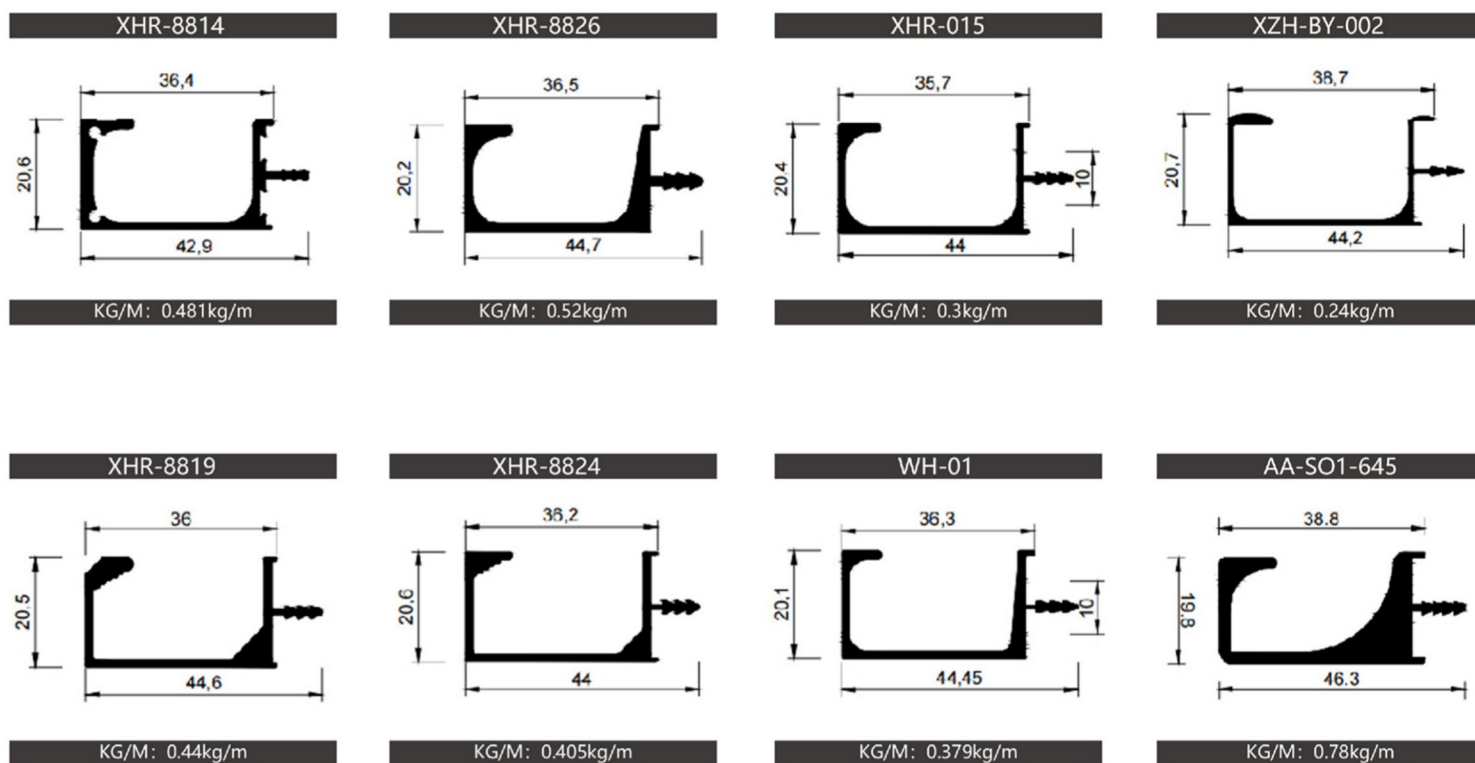

L-SHAPED HANDLE PROFILE

L型拉手型材

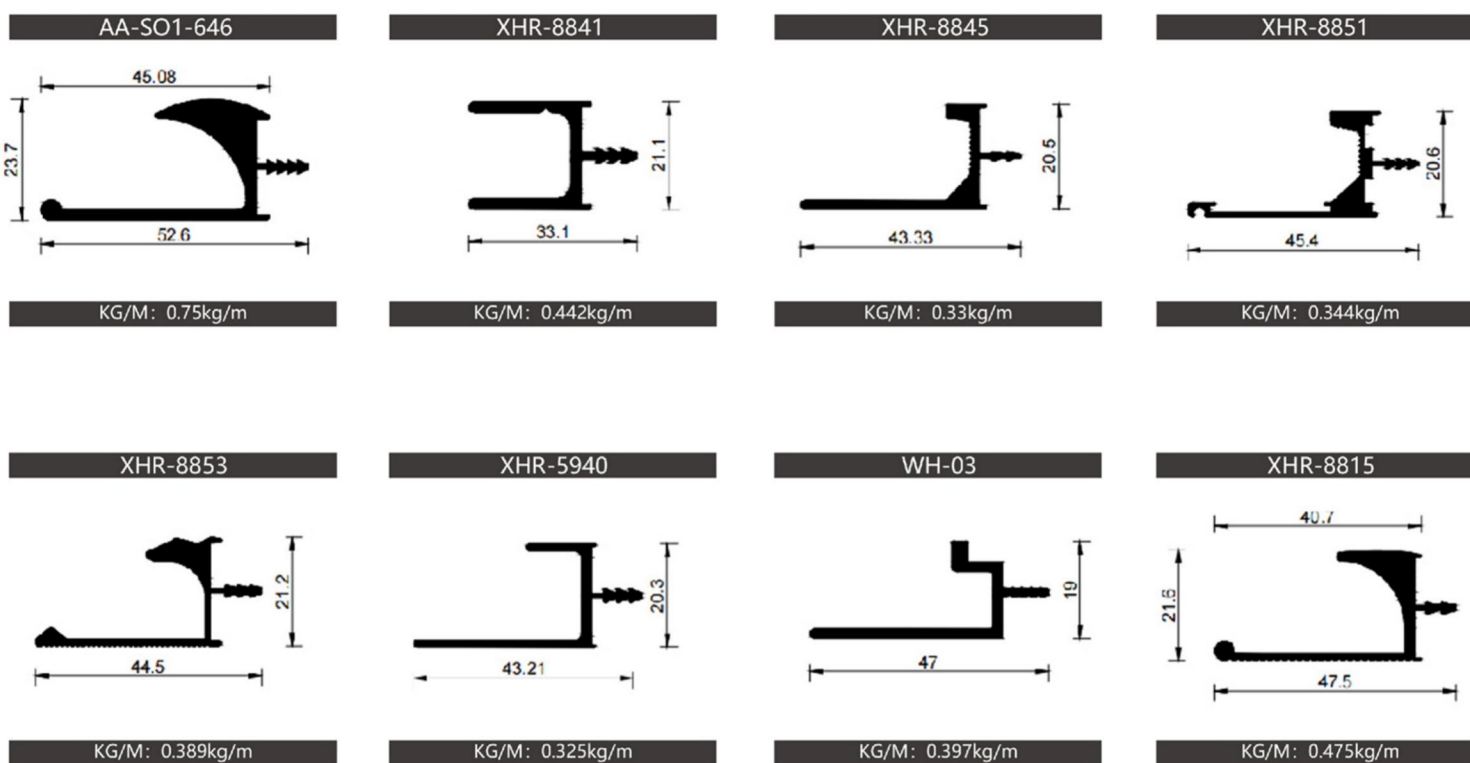

L-SHAPED PARENT HANDLE PROFILE

L型子母拉手型材



<p>XHR-8854</p> <p>KG/M: 0.283kg/m</p>	<p>G2676</p> <p>KG/M: 0.282kg/m</p>	<p>G1229</p> <p>KG/M: 0.262kg/m</p>	<p>BY-016A</p> <p>KG/M: 0.216kg/m</p>
<p>GLD-9241</p> <p>KG/M: 0.208kg/m</p>	<p>G2680</p> <p>KG/M: 0.214kg/m</p>	<p>XHR-8852</p> <p>KG/M: 0.412kg/m</p>	<p>G2675</p> <p>KG/M: 0.435kg/m</p>
<p>G1230</p> <p>KG/M: 0.408kg/m</p>	<p>BY-016</p> <p>KG/M: 0.364kg/m</p>	<p>GLD-9240</p> <p>KG/M: 0.288kg/m</p>	<p>G2681</p> <p>KG/M: 0.334kg/m</p>

CABINET PULL FREE PROFILE

橱柜免拉手型材



<p>KL-CWJ-6D-199</p> <p>KG/M: 0.77kg/m</p>	<p>KL-CWJ-6D-200</p> <p>KG/M: 0.71kg/m</p>	<p>XHR-8850</p> <p>KG/M: 0.357kg/m</p>	<p>XHR-8849</p> <p>KG/M: 0.284kg/m</p>
<p>W-791</p> <p>KG/M: 0.715kg/m</p>	<p>XHR-8848</p> <p>KG/M: 0.245kg/m</p>	<p>G004</p> <p>KG/M: 0.268kg/m</p>	

DINING TABLE PROFILE

餐桌型材系列

高级定制，用心打造。
ADVANCED CUSTOMIZATION, BUILT WITH HEART.

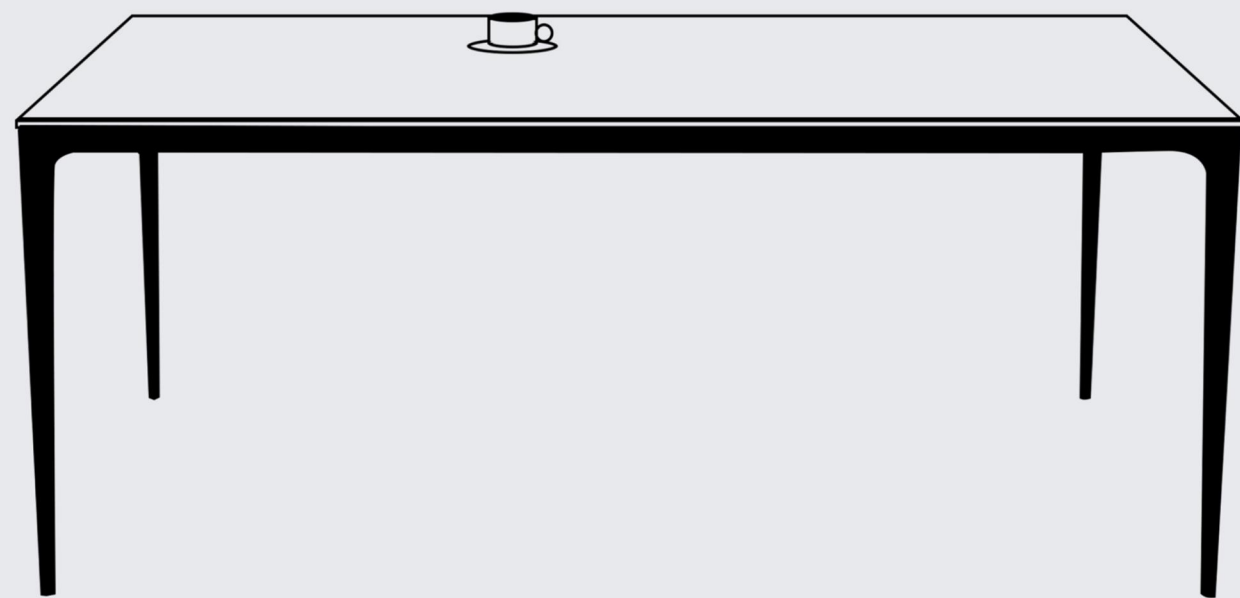



圆角款 ROUNDED CORNER

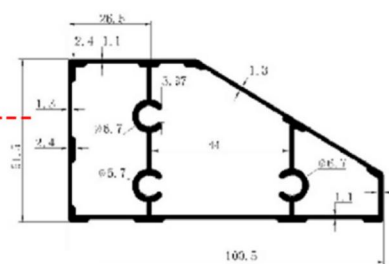
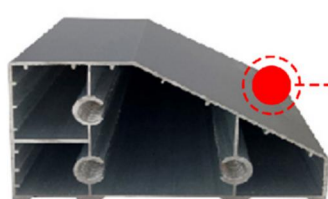

直角款 RIGHT ANGLE



菱形款 DIAMOND SHAPE

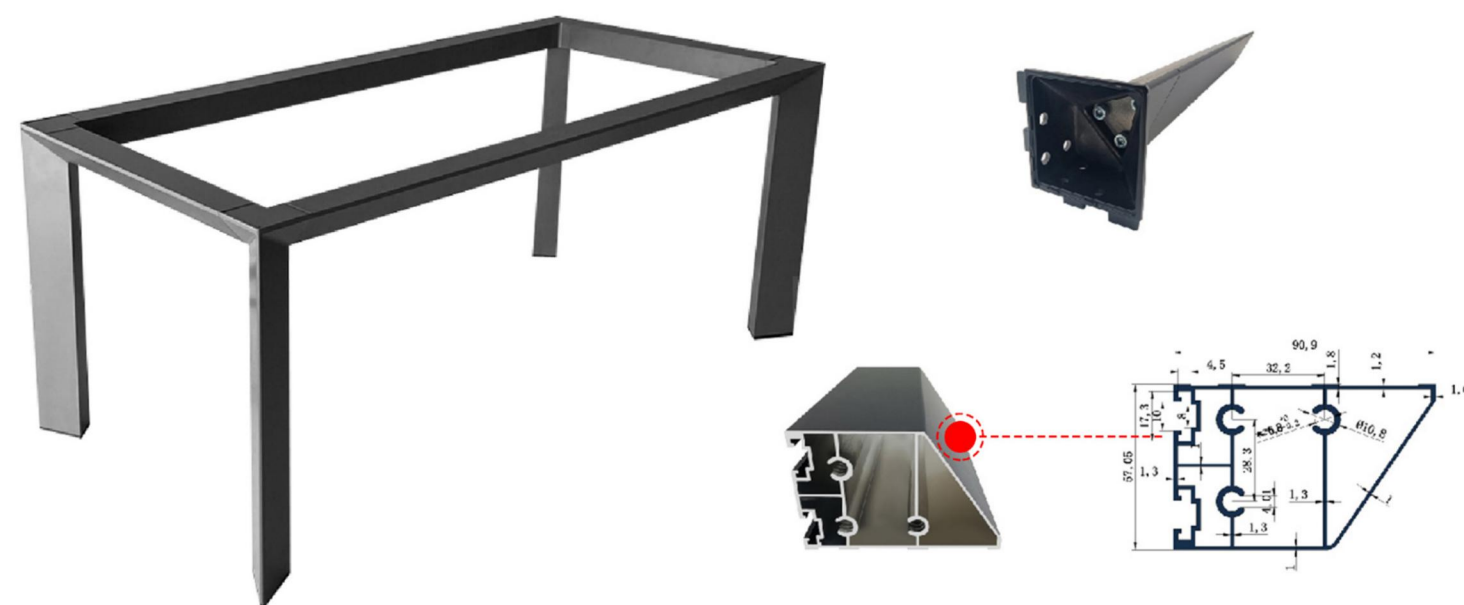

SHELF SERIES

置物架系列

高级定制，用心打造。
ADVANCED CUSTOMIZATION, BUILT WITH HEART.

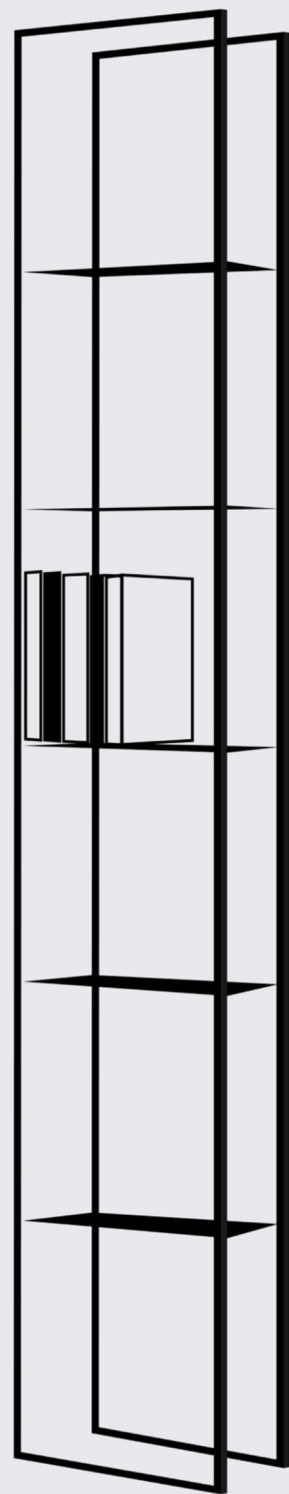
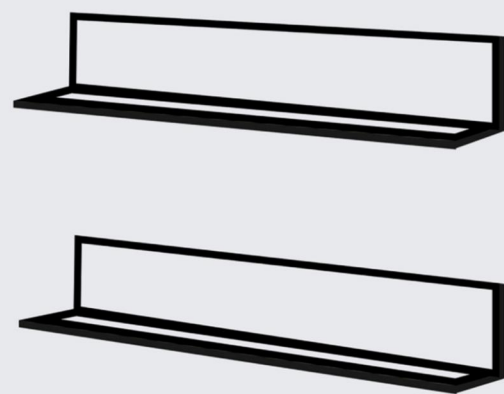

ALL IN ONE BOOKSHELF SERIES
一体书架系列



- 1、这是一种全新的壁挂式收纳系统，采用航空级型材与精加工制成
- 2、安装简单、稳固可靠，自带灯光系统，尺寸可任意选择。

- 1. This is a new wall mounted storage system, which is made of aviation grade profiles and finishing
- 2. The installation is simple, stable and reliable, with its own lighting system, and the size can be selected at will.



四种深度 Four depths

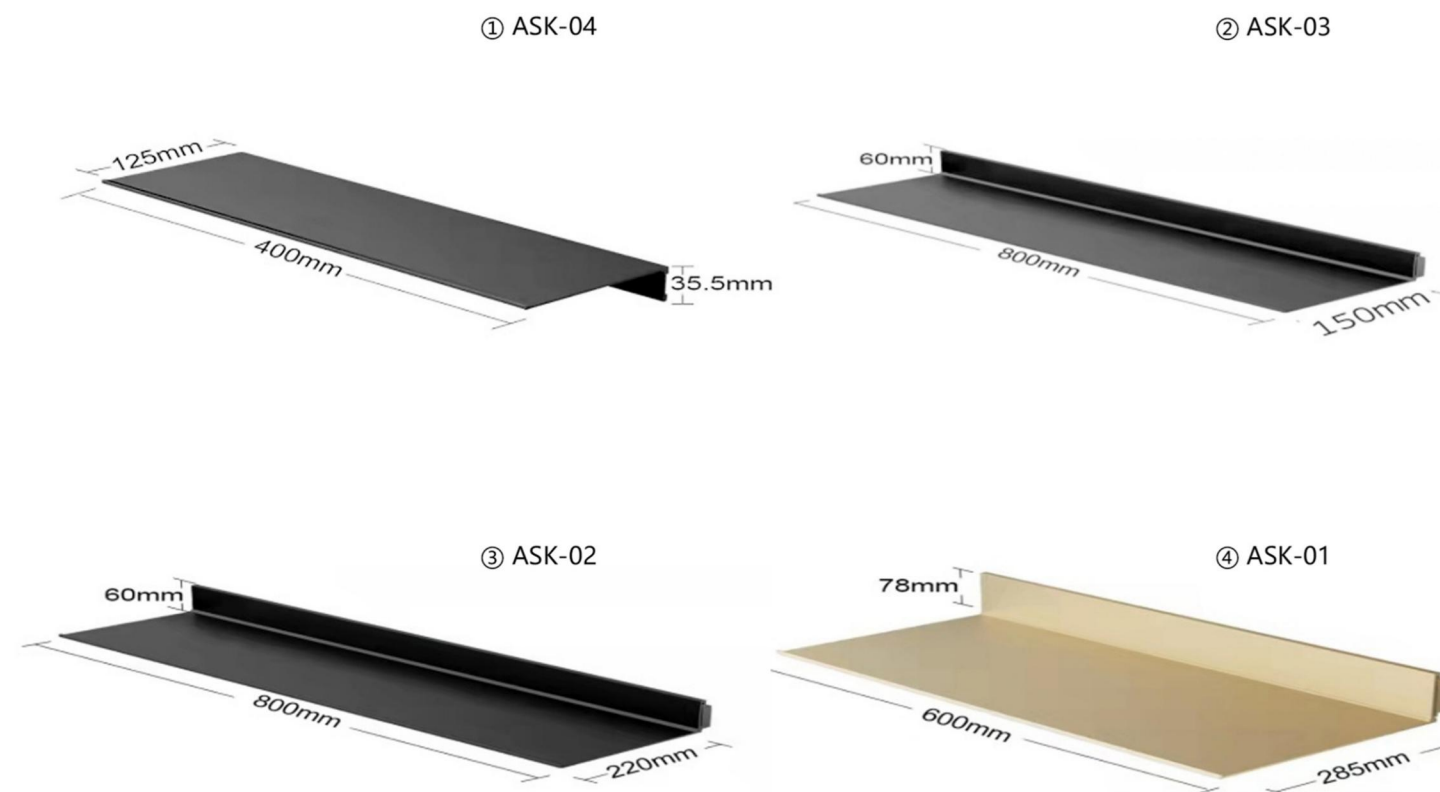

两种供电方式 Two power supply modes

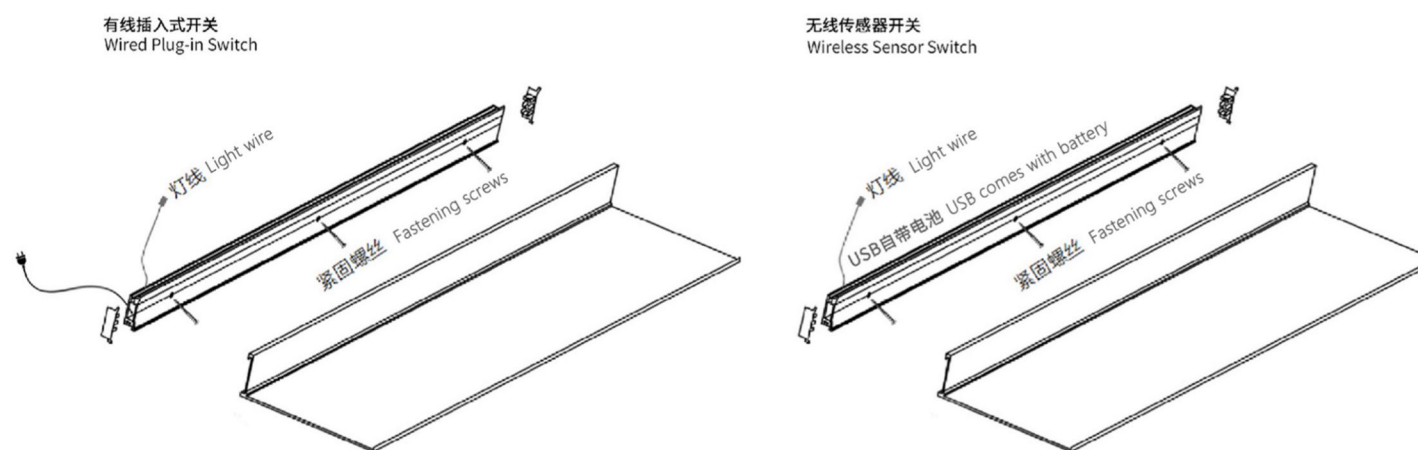

RED SHOPPING RACK

网红置物架

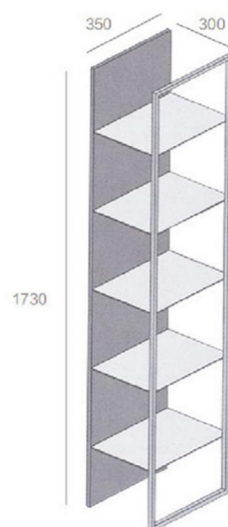

极简现代轻奢搭配，时尚美观实用四周发光的灯光向内打入，照亮置物架上的物品，营造良好氛围。适用于书房、客厅、茶室、酒店大厅、奢侈品陈列等

Minimalist modern light luxury collocation, fashionable, beautiful and practical, all around the luminous lights into the interior, illuminate the shelf items, create a good atmosphere. Suitable for study, living room, tea room, hotel hall, luxury goods display, etc

WALL CUPBOARD

吊柜



细节是整体美感的灵魂，细节的合理用度，创造组合就是美好产品本身的观点，细节见证品质，有细节的空间才是唯美的。充满活力的设计，独具个性与品味，体现着生活的抒情与写意，散发与之俱来的魅力使抒情的空间弥漫个性又奔放气氛。

Details are the soul of the overall beauty, the reasonable use of details, the creation of a combination is the point of view of the beautiful product itself, details witness quality, and the space with details is beautiful. The vibrant design, unique personality and taste, reflects the lyrical and freehand life, and exudes the inherent charm to make the lyrical space filled with personality and unrestrained atmosphere.

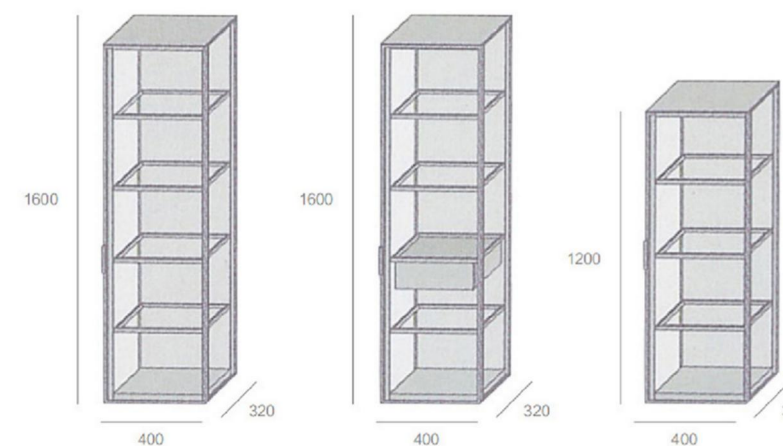

MINIMALIST ACCESSORIES

极简配件

高级定制，用心打造。

ADVANCED CUSTOMIZATION, BUILT WITH HEART.

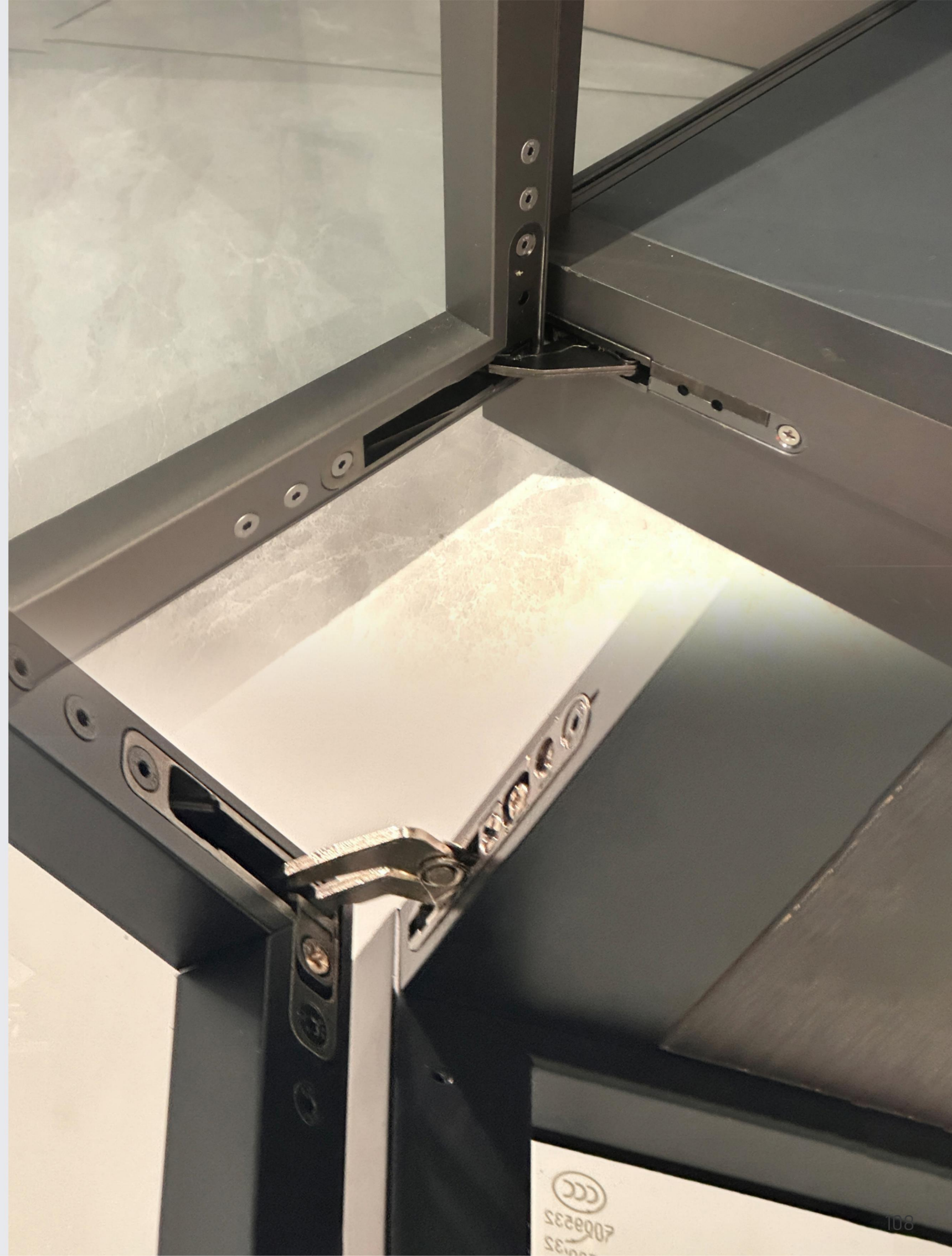

极简配件 MINIMALIST ACCESSORIES

SOFT CLOSE HINGES



straight bend

middle bend

big bend

ROUND CUP HINGE



straight bend

middle bend

big bend

AIR HINGES



Ordinary Air hinges

Heavy Duty Air hinges

SOFT CLOSE HINGES

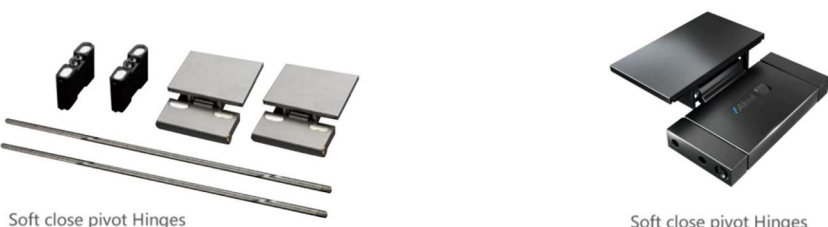

Soft close pivot Hinges

Soft close pivot Hinges

CORNER CONNECTOR



Corner connector for 20 series glass door

Corner connector for wardrobe

Corner connector for air hinges

Heavy duty corner connector for air hinges

MINIMALIST GLASS CABINET ACCESSORIES



shelf tray

SHCS

light strip

Anchor line corner code



transformer



lampshade



LED light line