



MecoFence

Redefine your outdoor living now by choose MecoFence



Foshan MexyTech Co.,Ltd

☎ 86-757-82131812

☎ 86-757-82727850

✉ info@mecofence.com

🌐 www.mecofence.com

📍 Room 2-8,Building B,Torch Innovation Park, Jihua 2 Road,
Chancheng District, Foshan City, Guangdong Province, China



Contents

02	Development of MecoFence
03	Why Choose MecoFence
05	Product Features
07	MecoFence Designs
23	Accessories and Colors Installation
25	Basement Instruction Fence Light
27	Fence Door
31	Engineering Projects
37	Certificates and Product Performance

Development

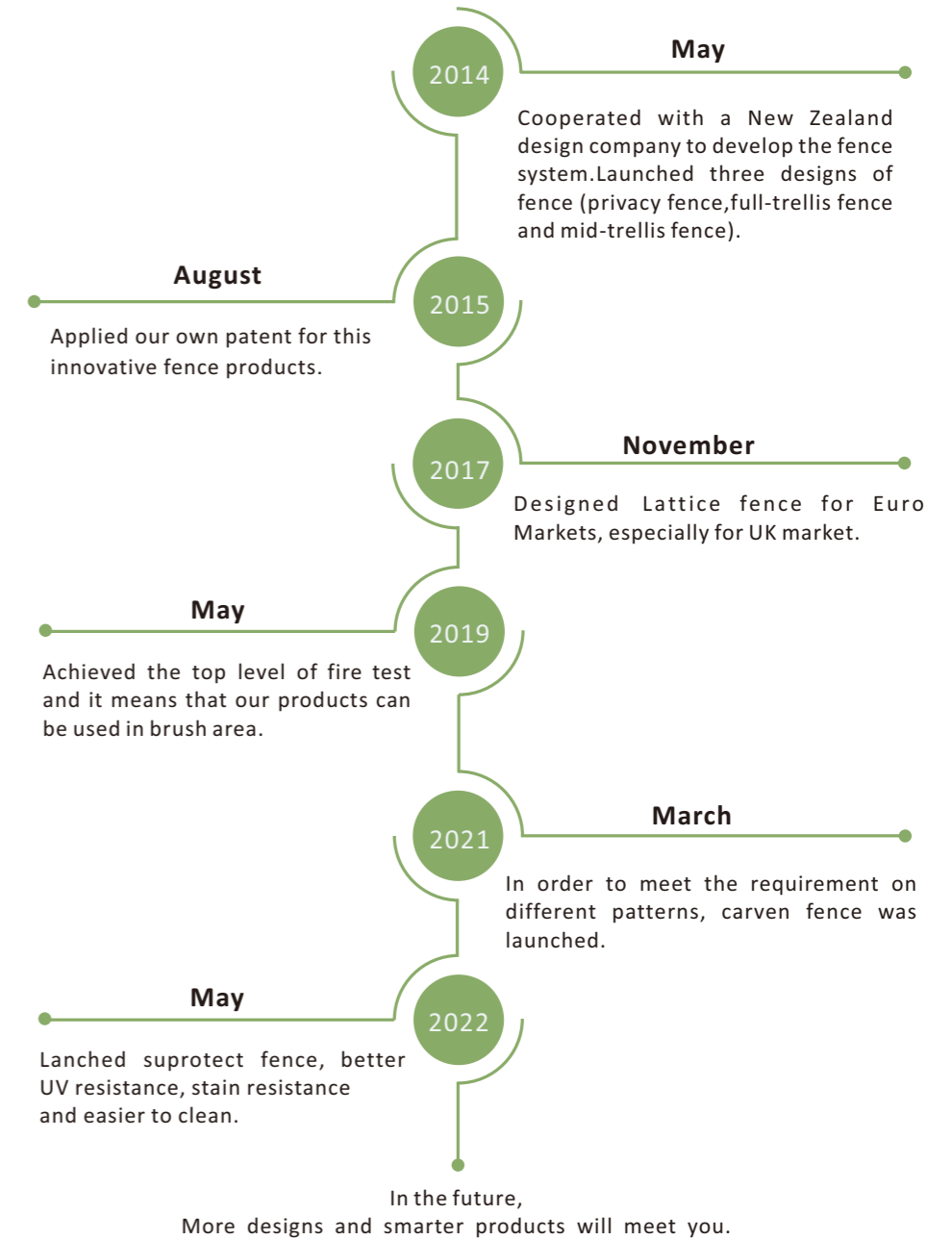

About US



MexyTech Co., Ltd has been in eco business since 2009. Through 13 years' development and research, we have been a company combining R&D, design, production, recycle, marketing in one. Nowadays, MexyTech has 60 production lines and a R&D testing lab. Moreover, our products are very popular to many countries.

Why choose MecoFence ? - Provide you a brand new life experience.

1. Value-added

You can enjoy comfortable outdoor living. What's more, your garden must be the unique one among your neighborhoods. What's more, we also supply different kinds of fence gate to match the fence system.

2. Durability and maintenance-free

You do not need to worry about the annual painting and oiling anymore. You can spend more time with the ones you love. Leaving the rest problems to us.

3. Total eco-materials

No formaldehyde, heavy metals elements or harmful substance. MecoFence can provide a healthy recreation area for your beloved kids.

4. Easy installation

Just 6 steps for the installation. You can enjoy the joy of DIY according to your own garden design.

5. Design support

If you need our support, our design team can provide some plans and 3D images so that you can have a better solution before installation.

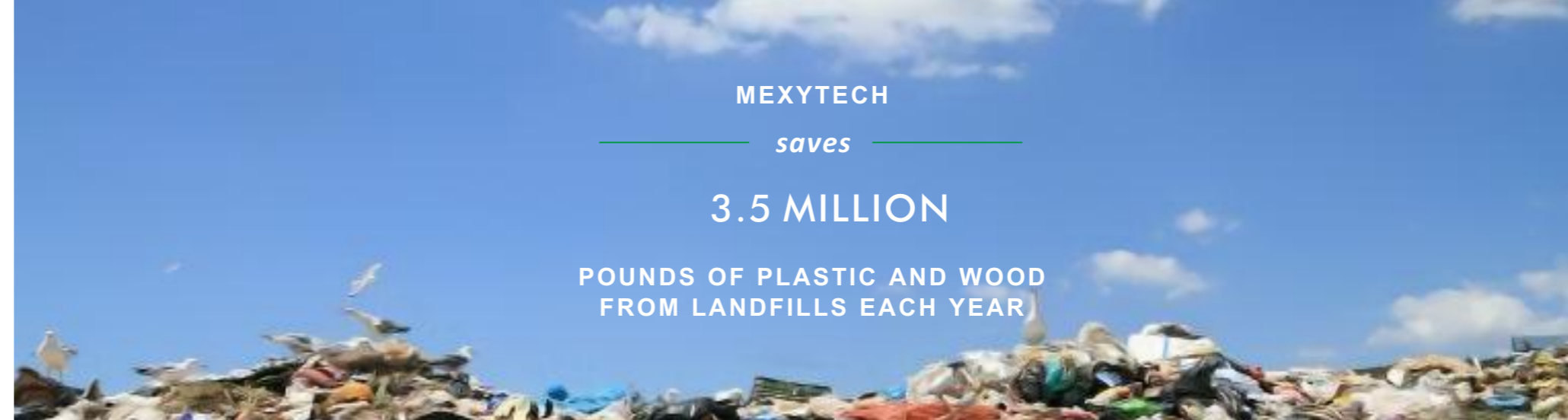

MEXYTECH

saves

3.5 MILLION

POUNDS OF PLASTIC AND WOOD
FROM LANDFILLS EACH YEAR



100 SET OF MECOFENCES

contain over

1 TONS

RECYCLED PLASTIC



MECOFENCE

CONTRIBUTES EFFORTS IN DEFORESTATION IMPROVEMENT

USING 5 SETS OF MECOFENCES

Can Save One Tree

Product Features

Durable for Outdoor Application - stable in any temperature and UV-resistant for a lifetime of different colors.



Easy Installation - Just few screws for the fence installation. Our smart design makes the fence DIY become possible.



Eco-friendly - Our WPC fence is made of recyclable materials. It doesn't contain harmful elements or heavy metals.



Confident Warranty - A maintenance-free solution. MecoFence offers 10 years warranty.



Patented Designs - Multiple smart designs of our fence provide not only beautiful appearance but also simple installation.



We do not fear comparisons

MecoFence **VS** Wood Fence

- Not rot, split, fade, deform and splinter
- Not crack from termite infestation
- Reduce deforestation
- Maintenance-free

MecoFence **VS** other WPC fence

- Patent products
- Cooperative design with foreign company
- 13 years experience on WPC business
- Better structure than other WPC fence system

MecoFence **VS** PVC

- No chalking
- Discolor from UV, insect repellent or cleaner
- More stable in different temperatures
- More natural feeling

According to the patented design, MecoFence applies the aluminum as structure and WPC as fence boards to give superior application performance and realistic visual appearance.

Privacy Fence



Privacy fence design is one of the most popular fence models. This model is very popular in Euro market. Compared to the traditional wire mesh fence and iron fence, MecoFence can satisfy clients for healthy concepts, natural appearance, privacy needs and DIY requirements. Privacy fence can be widely applied as domestic fencing, decorative partition, household decoration.



Standard Size:
W1800 * H1800mm
W1800 * H1150mm



S-CF01
180X24mm

Accessories

Post	Rail	Side Cover	L-fix	Post Base	Cap
					

Mid-trellis Fence



Standard Size:

W1800 * H1800mm
W1800 * H1150mm



S-CF01
180X24mm
S-CF02
90X24mm

Accessories



The style of mid-trellis is to use alternating synthetic wood boards across the back and front to give the fence the same views on both sides. On one side the design of mid-trellis is good for ventilation, on the other side this design can protect the privacy of neighbors.

Post	Rail	Side Cover	Spacer	L-fix	Post Base	Cap

Full-trellis Fence

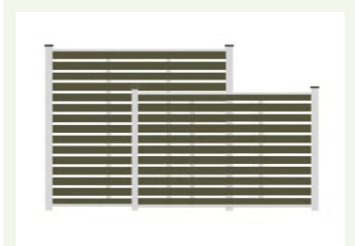

Standard Size:
 W1800 * H1800mm
 W1800 * H1150mm



S-CF02
 90X24mm

Accessories



This Design uses 90mm wide composite wood to create a continuous and horizontal design. Full-trellis design is more suitable for fencing using at front yard and it has improved the wind-tight problem of privacy design. Therefore, this style can do a good job as a complement of garden design or indoor partitions.

Post	Rail	Side Cover	Spacer	L-fix	Post Base	Cap

Woven Fence

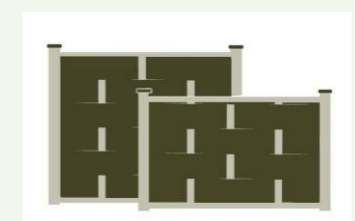

Standard Size:
 W1800 * H1800mm
 W1800 * H1150mm



S-MF04
 140X11mm

Accessories



We curve the fence boards across the back and the front to create a wavy appearance. Because of the concave and convex appearance, this fence design can give a beautiful stereo effect. The design can not only protect the privacy but also keep the good ventilation. This fence is quite popular in tropical area.

Post	Rail	Side Cover	Vertical Alu Tube	L-fix	Post Base	Cap

Carving Fence A



This fence is a good combination of traditional iron fence and WPC fence. The carved part can be WPC boards or metal. The different patterns can provide more options to clients and give better visual effect to our fence products. Due to the half privacy design, this fence is mostly applied as decorative boundary fence, coffee shop partitions or leisure areas.



Standard Size:

W1800 * H1800mm
W1800 * H1150mm



S-CF01
180X24mm

S-CF02
90X24mm

Accessories

Post	Rail	Side Cover	L-fix	Post Base	Cap
					

Carving Fence B

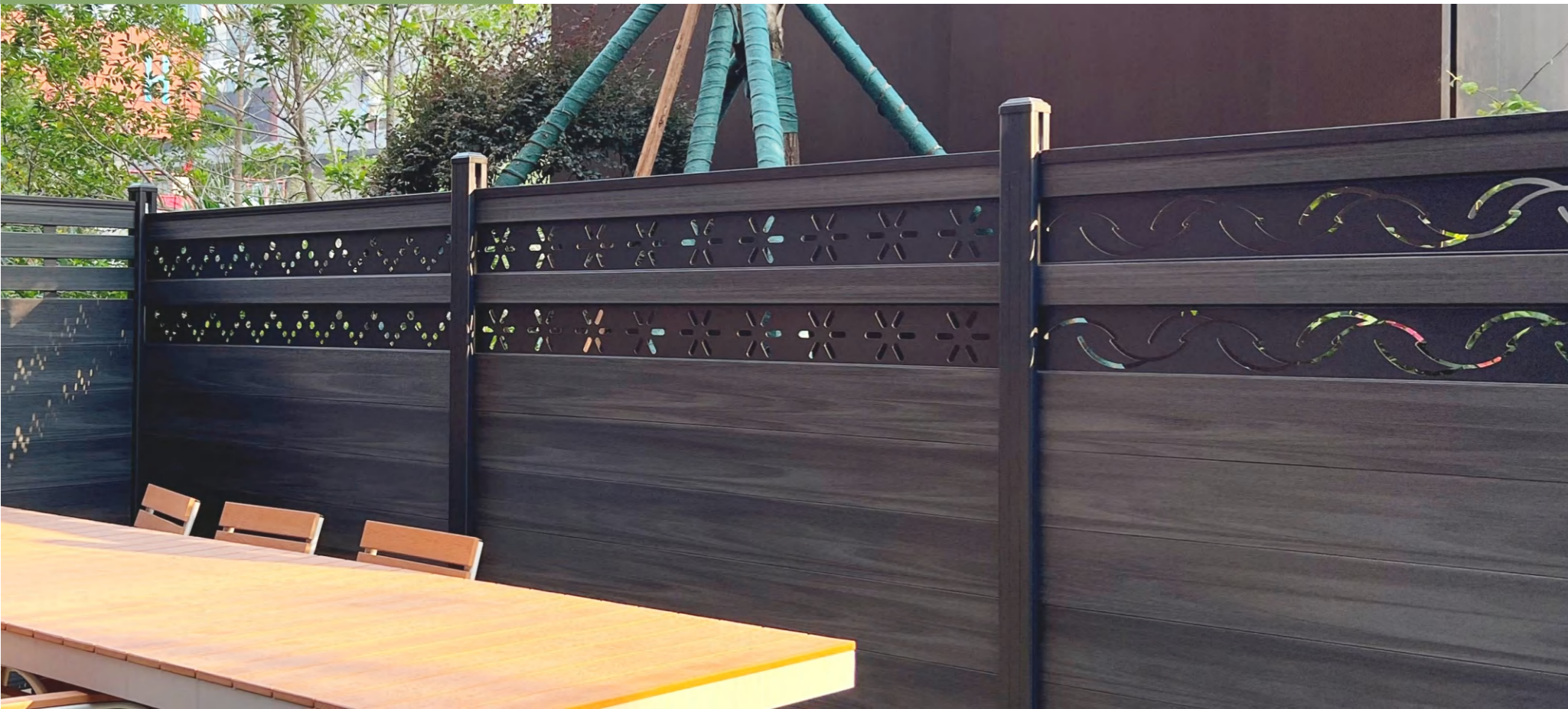

This fence is a good combination of traditional iron fence and WPC fence. The carved part can be WPC boards or metal. The different patterns can provide more options to clients and give better visual effect to our fence products. Due to the half privacy design, this fence is mostly applied as decorative boundary fence, coffee shop partitions or leisure areas.



Standard Size:

W1800 * H1800mm
W1800 * H1150mm



S-CF01
180X24mm

S-CF02
90X24mm

Accessories

Post	Rail	Side Cover	L-fix	Post Base	Cap
					

Slat Wall Fence

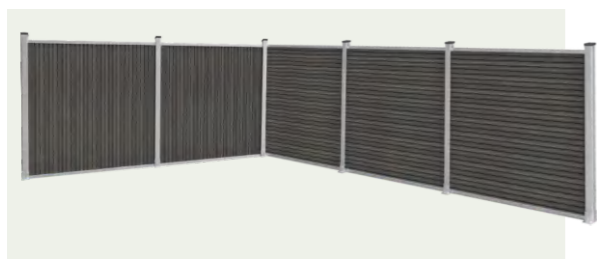
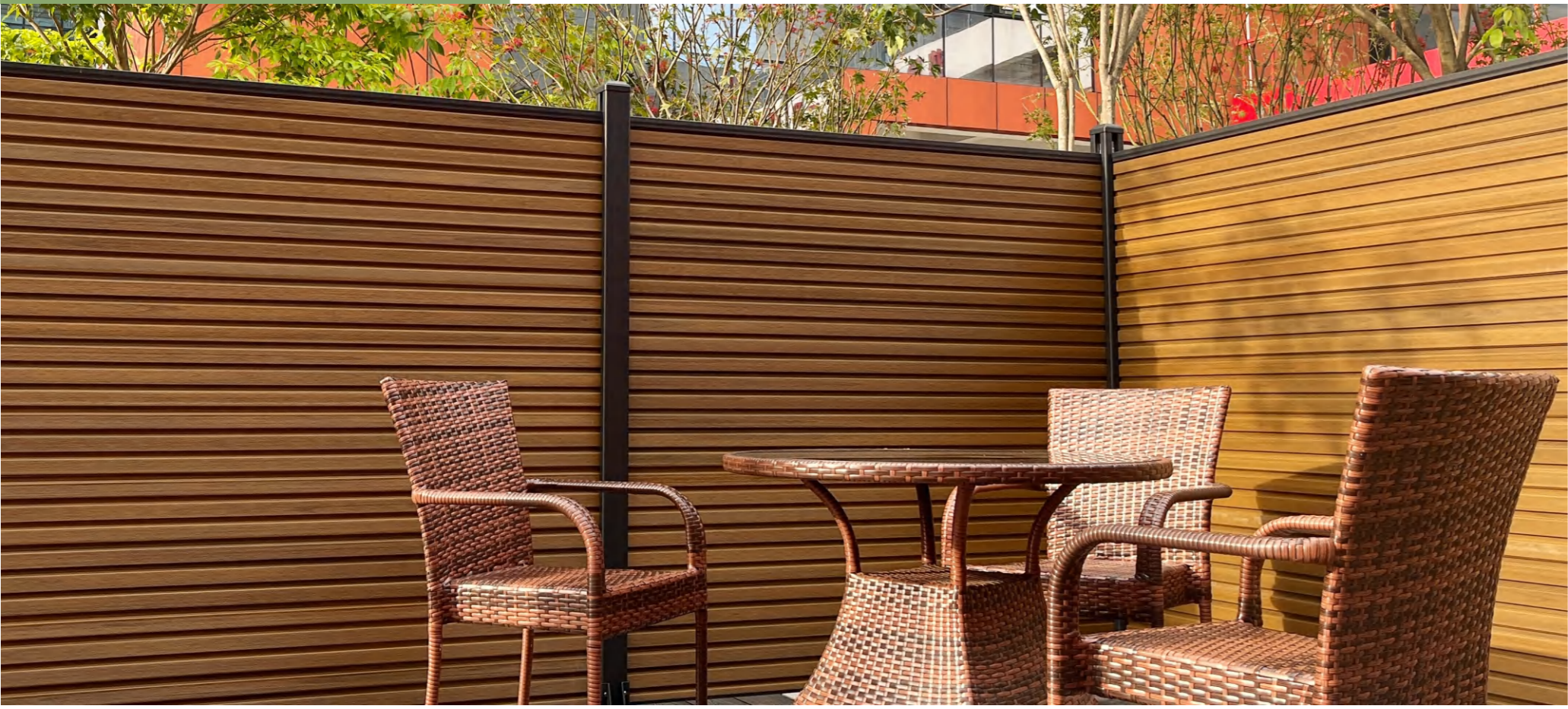

The slatted design is a new style, it can be installed both horizontally or vertically. The panel is co-extrusion wpc material, which is more scratch-resistant and easier to clean. While fence post is aluminum material, it makes the installation easier and more convenient.

Standard Size:
W1800 * H1800mm
W1800 * H1150mm

S-CF03
176X24mm

Patented design,
Better strength

Accessories

Post	Rail	Side Cover	L-fix	Post Base	Cap

Super Kit Fence





Standard Size:

W1830 * H1800mm
W1830 * H1150mm









S-CF01
180X24mm

Accessories



The newly launched co-extrusion fence series of MexyTech in 2022. Different from the MecoFence series, it uses co-extrusion technique for boards and posts. It is with excellent performance of waterproof, mildew-proof and UV proof. Also, because the boards and posts are the same color, it looks more harmony with each other. Multiple colors and designs for you to choose, it is another good choice for your garden.

Post	Post accessory 1	Post accessory 2	Post accessory 3	Rail	L-fix	Post Base	Cap
							

Accessories and Colors



- ① Post Cap
- ② Post
- ③ Basement
- ④ Rail
- ⑤ WPC Board
- ⑦ Side Cover
- ⑥ L-fix

Optional Colors



Teak

Antique

Dark Grey

Aluminum Colors

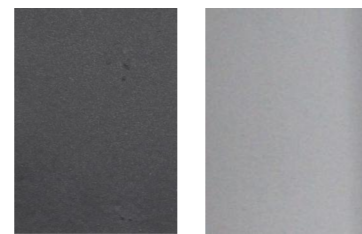

Black

Aluminum

Installation

1. Installation of Post

A. Fixing Post by using Post Base.

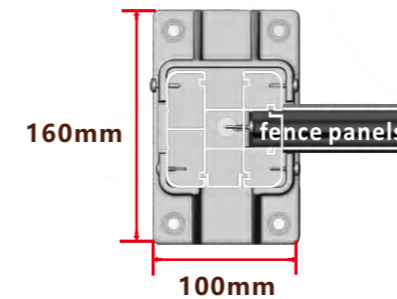

2. Install the bottom rail, using bracket to connect rail with post.

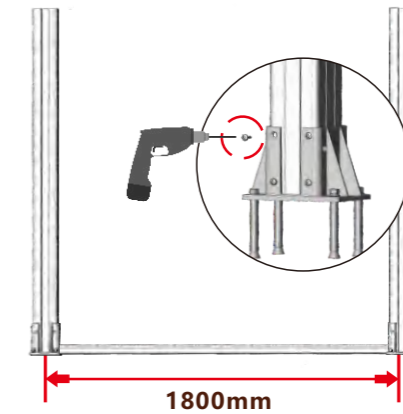
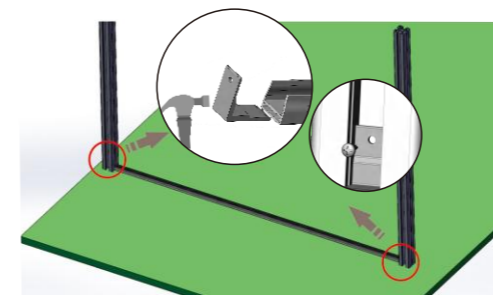

3. Install the wpc panels one by one.

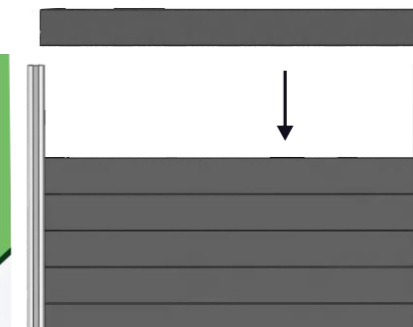

B. Fix the aluminum posts with cement. 500mm into the soil.

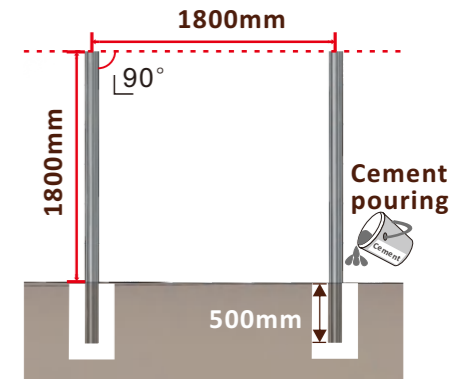

4. Install the top rail and post cap.

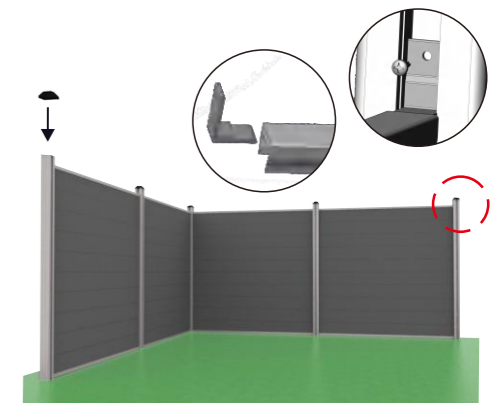

Basement Instruction

NEW DESIGN

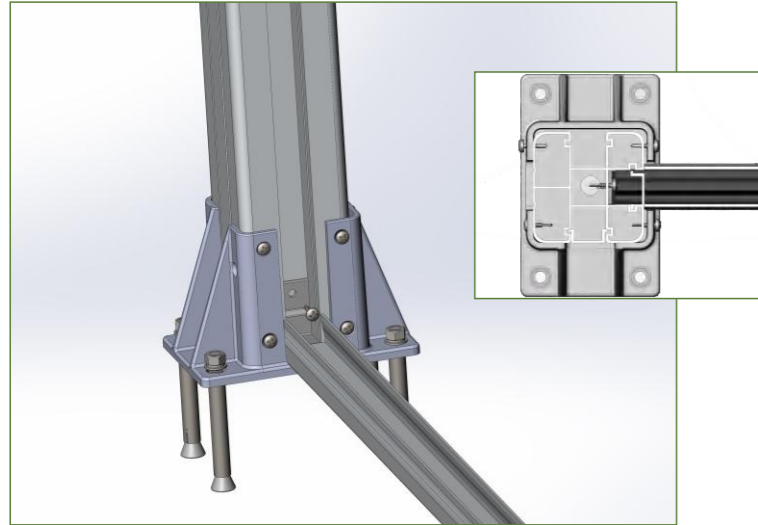

In order to increase the bearing of heavier wind loading, we will not apply welding on our basement, because it is not firm enough when meeting storms. Moreover, we redesigned the basement and increased some reinforcements, which can make the whole system stronger.

No.	Item	Post Base
1	Model Name	PB01
2	Application	Normal post applications
3	Optional Colors	Aluminum & Black
4	Size	160x100x100mm(LxWxH)
5	Materials	Aluminum
6	Surface Treatment	Powder coating



Aluminum



Black



Fence Light



Fence Gate

After you installing the fence. A gate with matching fence design is definitely needed for the garden. In order to meet the application needs of customers, MexyTech set up a fence gate processing department. The fence gate is assembled with fence panel and aluminum frame, which is consistent with the fence in structure, giving a sense of high-end and fashion. The product adopts an assembly detachable structure, and the fence plate can be replaced at any time, so that maintenance is free.

Double Swing Gate



Single Swing Gate



Standard size:
W 900 x H 1700 mm



Electric Fence Gate

ELECTRICAL FOLDED SWING GATE



TURNING SECTIONAL SLIDING GATE



SLIDE GATE ON FENCING



TELESCOPIC GATE



ELECTRICAL SWING GATE



Gate designs

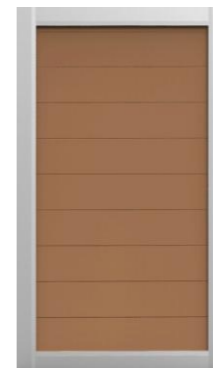

Style A



Style B

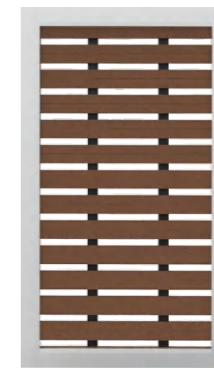

Style C



Style D

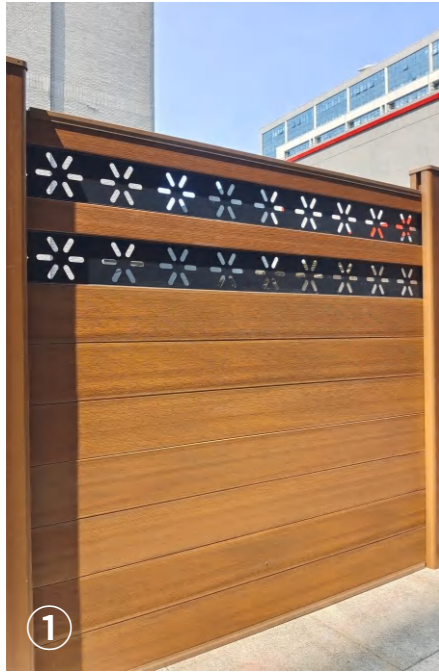

- ① China - Super Kit Fence - Teak
- ② Guangzhou - Full-trellis Fence - Teak
- ③ Guam - Privacy Fence - Dark Grey
- ④ Canada - Privacy Fence - Antique
- ⑤ Holland - Privacy Fence - Dark Grey
- ⑥ China - Mid-trellis Fence - Dark Grey
- ⑦ China - Mid-trellis Fence - Teak
- ⑧ Maldives - Woven Fence - White

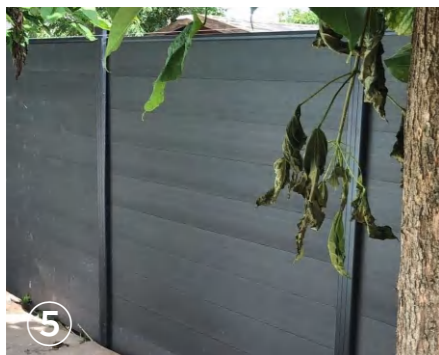



Product Comparison

Aluminum post VS Others



Thickness 1.7mm
Strength: ★★★★★



Post size: 80x80mm
Strength: ★★★★★



Coating thickness: 61.6um
Durability: ★★★★★



Thickness : 1.45mm
Strength :★★★



Post size : 70x70mm
Design:★



Coating thickness :34.6um
Durability:★

Co-extrusion Post VS Others

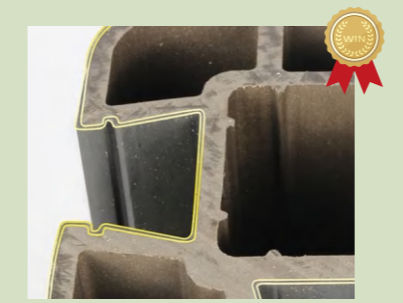

Material: Co-extrusion
Design:★★★★★

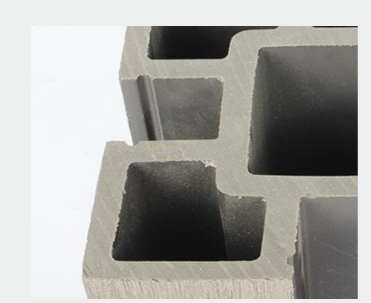

Material :Common WPC
Design:★★

Fence Boards VS Others



Thickness:24mm
Strength:★★★★★



Thickness:20mm
Strength:★★

Post Base VS Others



Iron aluminum, enhance
Strength:★★★★★



lastic base, no strenght, no design
Strength:★

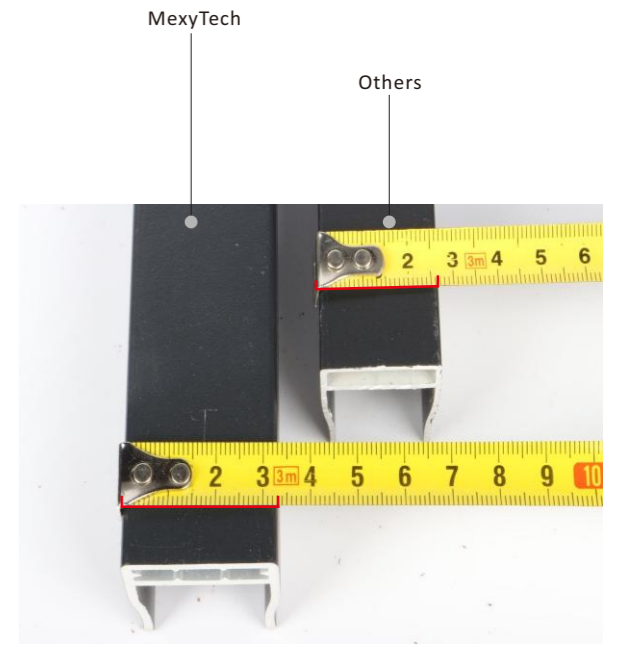
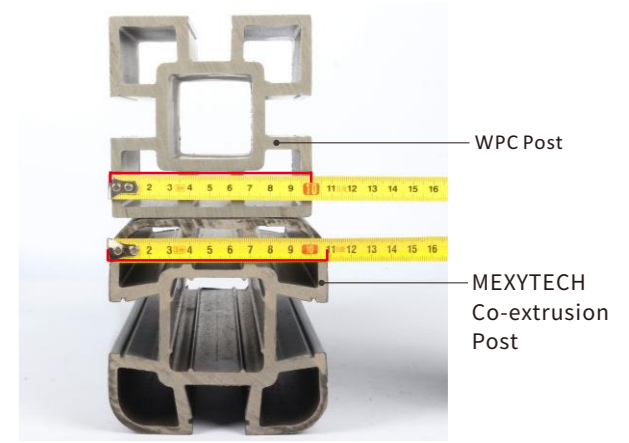

Certificates

Withstand Wind Level 9

Issue Date: 2018/3/9 Intertek Report No. 180206062GZU-003

Test Items, Method and Results:

No.	Test Item	Test Parameter	Test Result	Verdict
1	Wind resistance test	Test method: Client's requirements Requirements: The fencing system shall resist a maximum horizontal quarter point load of 372,1 N/m ² x effective area of system (as 9 Beaufort scale or 9 wind level)	There was no failure, nor any evidence of disengagement of any component, nor visible cracks in any component	Pass

Patented Certificate

Product Performance

No.	Item	Standard	Result	Unit
1	Moisture Content	EN 322:1993	0.89	%
2	Impact Resistance	EN15534-1:2004	8.95	mm
3	Modulus of Elasticity	EN15534-1:2004	3758	Mpa
4	Bending Strength	EN15534-1:2004	26.8	Mpa
5	Linear Thermal Expansion	EN15534-4:2014	38.6 * 10 ⁻³	Mm/m°C
6	Deflection Temperature	ISO 75-1:2013	80	°C
7	REACH	(EC) NO. 1907/2006	Pass	/
8	Fire-resistance	ASTM E84	Class A	/
9	Shore Hardness	ASTM D2240-05	70	D

Certificate & Test report

Foshan MexyTech Co., Ltd
TEST REPORT

ISO9001

FSC

Reach