

Installation Guide

WWW.MECOFENCE.COM

Style: laser cut artistic fence 01



Tools

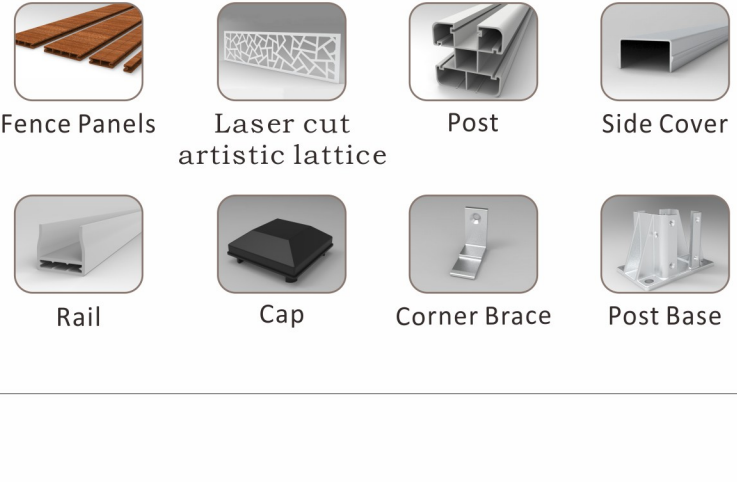

Hardware

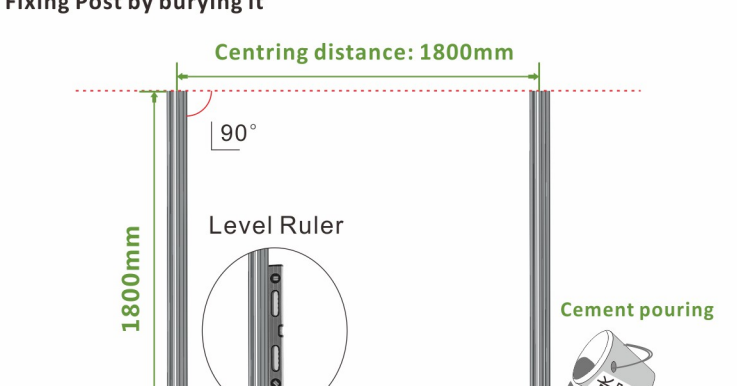

Fence Accessories

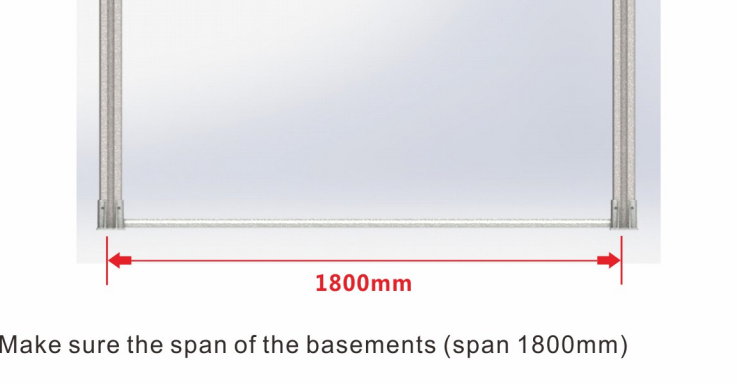
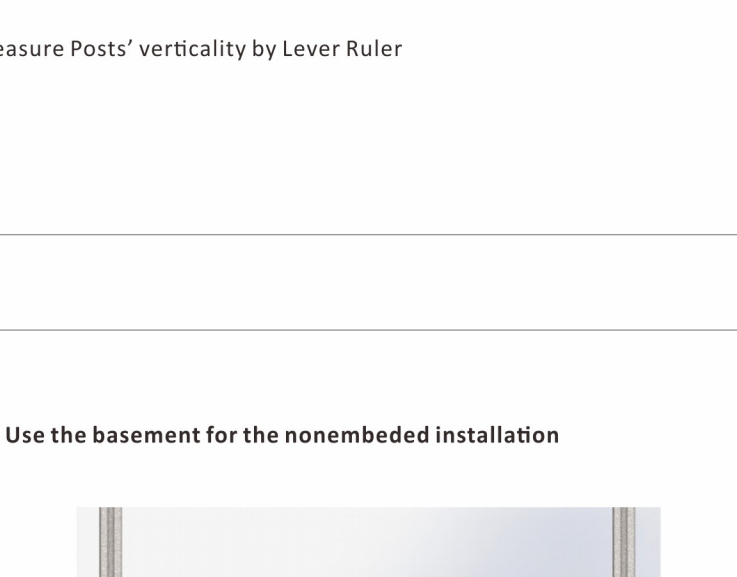

Installation

STEP 1 Install the post

A. Fixing Post by burying it

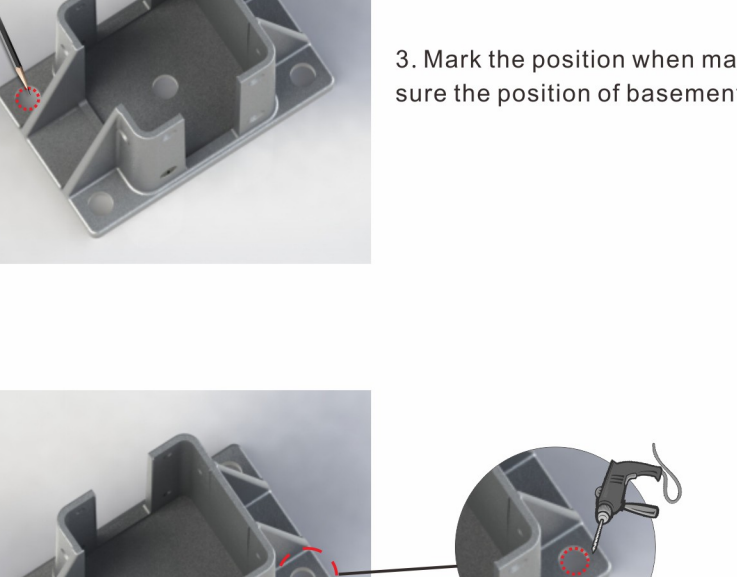

1. Determine the position of two posts (centring distance 1800mm), drill a hole of 500mm depth, then put post into it and keep it vertical.

Measure Posts' verticality by Lever Ruler

B. Use the basement for the nonembedded installation

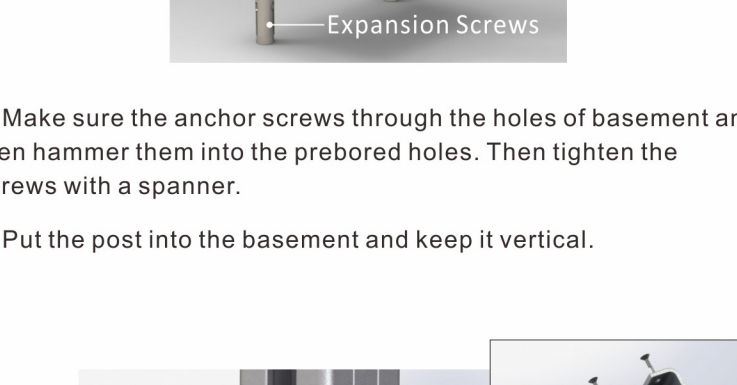

1. Make sure the span of the basements (span 1800mm)

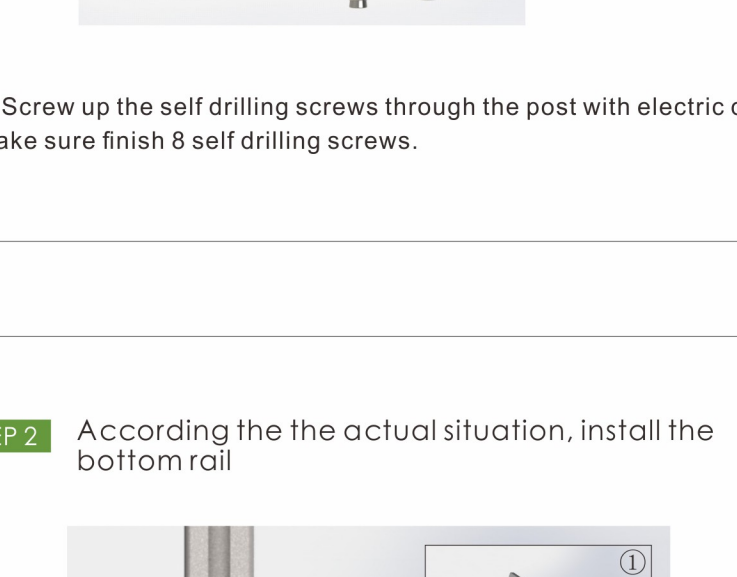

2. Direction of the basement: the side with 100mm long parallel with fence board while the side with 160mm long should be perpendicular to the fence board.

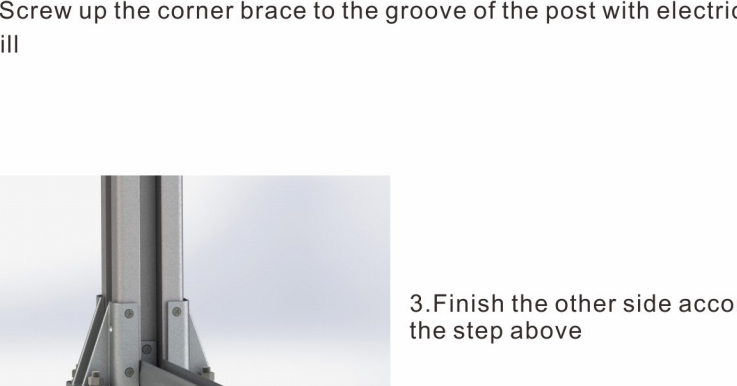

3. Mark the position when make sure the position of basement.

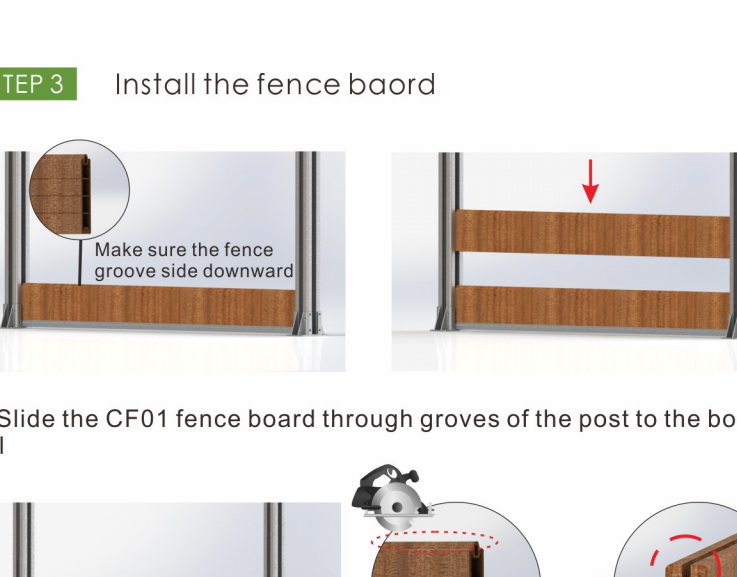

4. Take away the basement and prebore four holes with impact drill.



5. Make sure the anchor screws through the holes of basement and then hammer them into the prebored holes. Then tighten the screws with a spanner.

6. Put the post into the basement and keep it vertical.

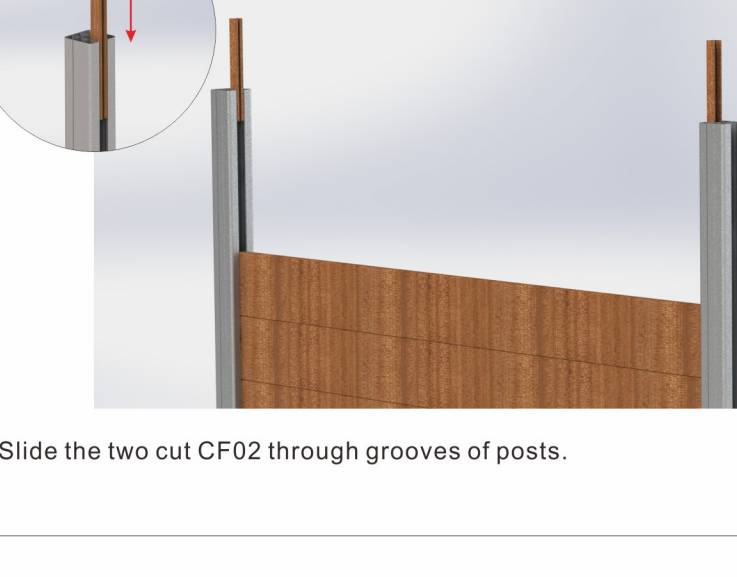

7. Screw up the self drilling screws through the post with electric drill. Make sure finish 8 self drilling screws.

STEP 2 According the the actual situation, install the bottom rail

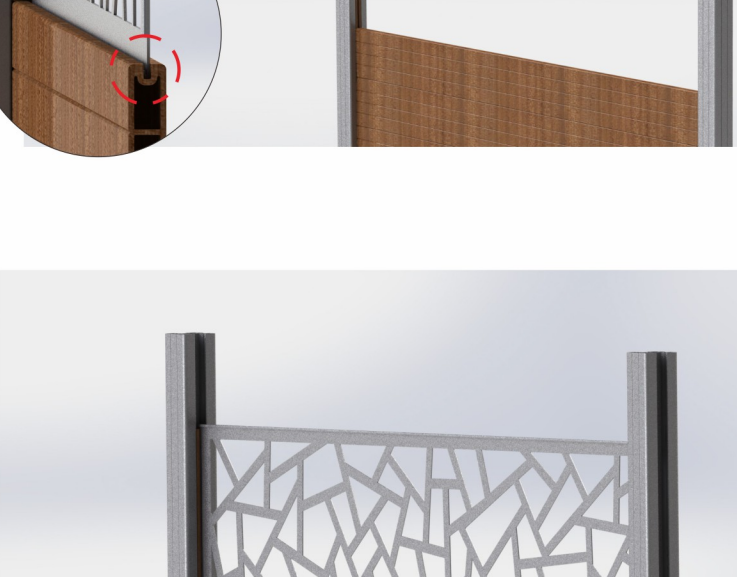

1. Like photo 1, hammer the L corner brace into the rail

2. Screw up the corner brace to the groove of the post with electric drill

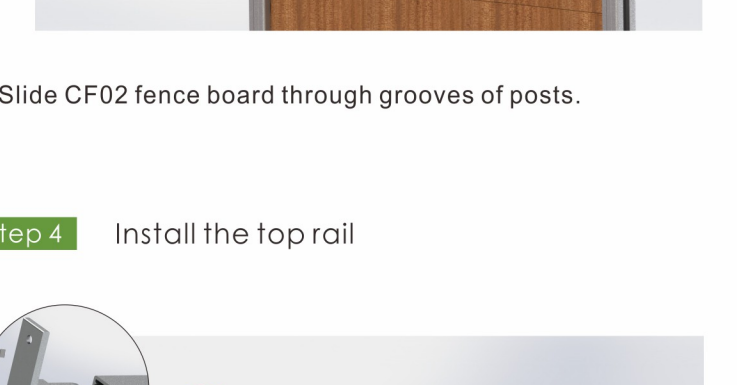

3. Finish the other side according the step above

STEP 3 Install the fence board



1. Slide the CF01 fence board through groves of the post to the bottom rail

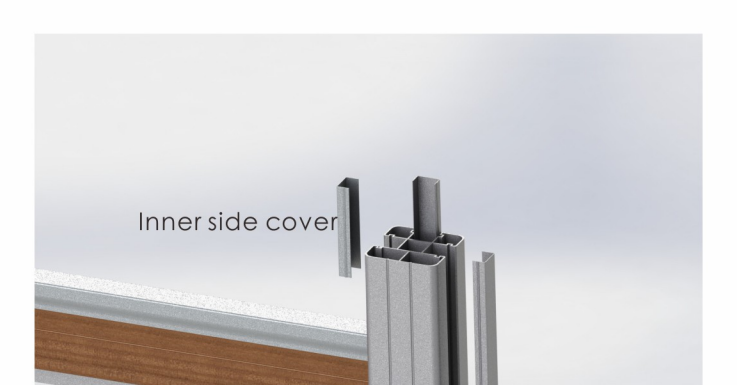

2. Cut the seventh CF01 fence board according to the photo.



3. Fix the seventh CF01 fence board.

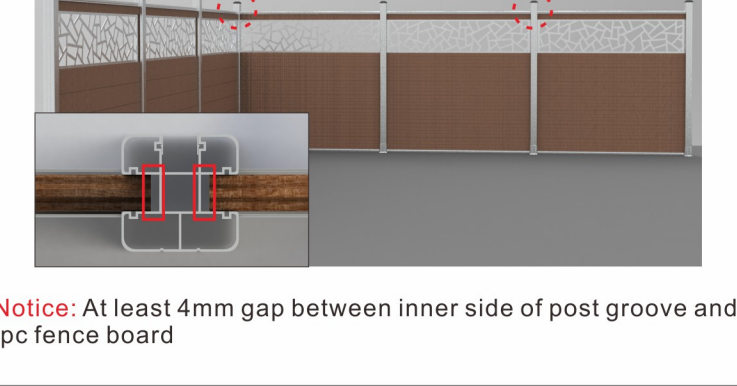

4. Cut the CF02 into two according to the diagram for fixing the position of artistic lattice

5. Slide the two cut CF02 through grooves of posts.

6. Slide the laser cut artistic lattice through the grooves of cut CF02 to the groove of CF02 fence board.

7. Slide CF02 fence board through grooves of posts.

step 4 Install the top rail

1. Make sure the direction of corner braces upward and then hammer them into the rail

2. Put the top rail into right position. Make sure the rail stuck into the fence board.

3. Directly screw up the corner brace into the post.

4. Finish the installation at the other side.

STEP 5 Install the side cover

Slide the side cover through the groove of post. Make sure the installation of inner side cover

STEP 6 Fix the post cap

Stick the post cap into top of the posts and all steps are finished.

*Notice: At least 4mm gap between inner side of post groove and wpc fence board