

**meite**<sup>®</sup>  
TOOLS FOR PROFESSIONALS

CATALOGUE  
2019



# PROFESSIONAL TOOLS & FASTENERS



**meite**<sup>®</sup>

Guangdong Meite Mechanical Co., Ltd

Add: NO.10, Shunjing St., Hegui Industrial Park(B), Lishui Town, Nanhai District, Foshan, GD 528241, China

Tel : (0086)757-85126856

Fax : (0086)757-85126850

Http://www.gdmeite.com



[www.gdmeite.com](http://www.gdmeite.com)



**meite<sup>®</sup>**

**A complete pneumatic tools,  
fasteners and accessories supplier.**

Established in 1996, Guangdong Meite Mechanical Co., Ltd. is a professional pneumatic products company involving in combination of R&D, manufacturing, sale and service. Meite offers a complete range of air nailers & staplers, fasteners, accessories, compressors, spray guns and air tools for different industries. After 20 plus years rapid development, Meite has become a leading manufacturer for pneumatic products in China.

Since its foundation, Meite introduced the up-to-date technology from all over the world. And our 70,000m<sup>2</sup> plants are equipped with the latest CNC machineries, heat treatment, forging and painting equipments etc. Meite is desired to build a manufacturing base for pneumatic products in China.

Everything begins with the customers. Meite always listens to the users in the field and produces the tools and fasteners to fit their needs. Meite is committed to providing high quality products and professional services for the global customers.



## END TO END MANUFACTURING



**Professional Grade Products**



**A ISO 9001 CERTIFICATED MANUFACTURER**

**Industrial Coil Nailer**

CN55B	CN70E	CN70DS	CN100EPAL
			
Pg.09	Pg.12	Pg.13	Pg.16

**C Ring Plier / Clipper**

SC760C	M66L
	
Pg.23	Pg.28

**Headless / Mini Brad Pinner**

MT840	MT850
	
Pg.35	Pg.36

**Fine / Medium / Heavy Wire Stapler**

MTP8016	MT432KLM	MT-N851-H	MT-N851-L
			
Pg.42	Pg.48	Pg.50	Pg.51

**Concrete & Steel Nailer**

CS3025	MTCS3040
	
Pg.64	Pg.65

**NEW**  
**PRODUCTS**  
**AT A GLANCE**

<b>Construction Coil Nailer</b> CN452S	P08
<b>Industrial Coil Nailer</b> CN55, CN55B, CN55K, CN55C, CN65B, CN70B, CN70C, CN70E, CN70DS, CN80B, CN80DS, CN80E, CN90, CN100B, CN100, CN100EPAL, CN100DS, CN130	P08-17
<b>Industrial Strip Nailer</b> SF13021	P17
<b>De-Nailer</b> T50SC, NP55, NP70	P19
<b>Wire Collated Coil Nails</b>	P21
<b>C-Ring Plier</b> SC760B, SC760C, SC7C, SC7C-P, SC7E, SC7E-P, SC77XE, MT-HC45	P23-27
<b>Industrial Stapling Plier</b> P88U	P27
<b>Clipping Tool</b> M66L, M66B, M65B, M46B, M45B	P28-29
<b>C-Rings &amp; Clips</b>	P31
<b>Headless Pinner</b> MP622, P630C, MP630, MP635, MP650B, MT840, MT850	P33-36
<b>Headless Pins</b>	P37
<b>Fine Wire Stapler</b> MT7116, MT7116S, MT7116LN, 7116, 7116C, 7116B, MT8016, MT8016S, MT8016LN, 8016D, 8016F, 8016B, MTP8016, MTP5016, MT5016, MT5016S, MT5016SLN, 1416, 1416B, MT425J, 422J, MT1025J, 1022J	P39-47
<b>Medium Wire Stapler</b> MT432KLM, MT440KLM, 440KB, 9240B, 635TR	P48-49
<b>Heavy Wire Stapler</b> MT-N851-H, MT-N851-L, N851F, PW2638-L	P50-52
<b>Fine Wire Staples</b>	P54-55
<b>Medium Wire Staples</b>	P56
<b>Heavy Wire Staples</b>	P56
<b>Brad Nailer</b> MTF32, F32D, F32, F50G, F50C, T64A, T50SA, T50MA, FST50, ST64	P58-62
<b>Concrete And Steel Nailer</b> CS3025, MTCS3040L, MTCS3040, MT-G38	P64-65
<b>Picture Frame Tacker</b> P515, HM515, HF18, V1015B	P67-68
<b>Deco Nailer</b> ZN1400, ZN-12	P69
<b>Carton Closing Stapler</b> HB3515, HB3518, ADCS-19, ADCS-22, RATA-19, RAIA-19	P71-73
<b>Special Tools</b> MFS50, TH-1213F	P75
<b>Accessories</b>	P76



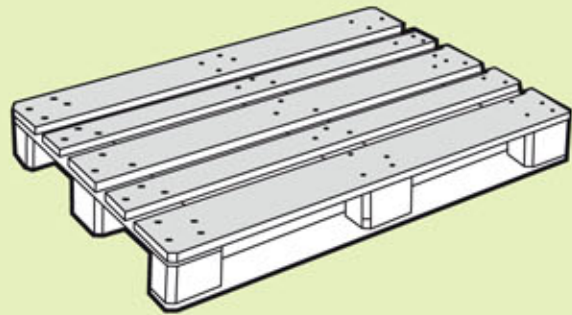

APPLICATIONS	TOOL SERIES	MODEL	PAGE
Pallets Crates/Wood Case Packaging	Coil Nailer	CN55 CN55B	8, 9
		CN55C CN55K	9, 10
		CN65B	10
		CN70B CN70C	11
		CN70E CN70DS	12, 13
		CN80B	14
		CN90	14
		CN100B CN100 CN100EPAL	15, 16
		CN130	17
		Nail Puller	T50SC NP55 NP70
Packaging	Carton Closing Stapler	N851F MT-N851-HMT-N851-L	50, 51, 52
		PW2638-L	52
		SF13021	17
		TH-1213F	75
Packaging	Carton Closing Stapler	HB3515 HB3518	71
		ADCS-19 ADCS-22	72
		RATA-19 RAIA-19	73

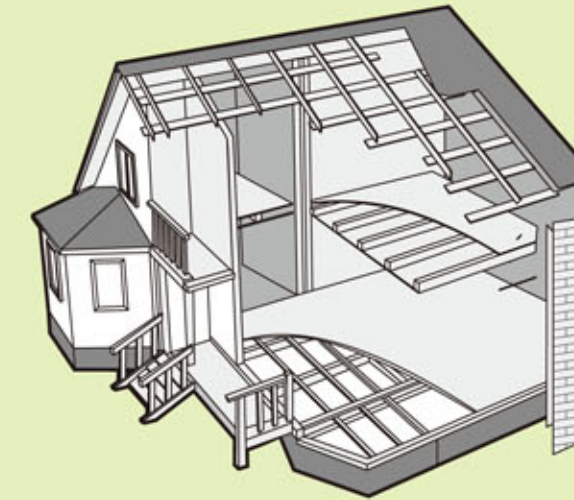

APPLICATIONS	TOOL SERIES	MODEL	PAGE	
Flooring Decking Siding Sheathing Fencing	Coil Nailer	Flooring Nailer	MFS50	75
		Construction Coil Nailer	CN452S	8
		CN55 CN55B	8, 9	
		CN55C CN55K	9, 10	
		CN70B CN70C CN70E	11, 12	
		CN80B	14	
		CN90	14	
		Heavy Wire Stapler	N851F MT-N851-HMT-N851-L	50, 51, 52
		Concrete and Steel Nailer	CS3025	64
		Windows Door	Fine Wire Stapler	MT7116 7116 7116B 7116C
MT8016 8016B 8016D 8016F	39, 45, 43, 44			
1022J	46			
422J	46			
MT5016 MTP5016	39, 42			
MT425J MT1025J	47			
1416 1416B	43, 45			
MT432KLM MT440KLM	48			
Medium Wire Stapler	440KB			49
9240B	49			
Interior Decoration	Headless Pinner Nailer	635TR	49	
		MT-N851-H MT-N851-L	50, 51, 52	
		N851F PW2638-L	52	
		Brad Nailer	MTF32 F32 F32D F50C	58, 59, 60
		MP622 MP630	33, 34	
		MP635 MP650B	34, 35	
		MP840 MP850	35, 36	
		Headless Pinner Nailer	MP622 MP630	33, 34
		MP635 MP650B	34, 35	
		Mini Brad Pinner	MP840 MP850	35, 36

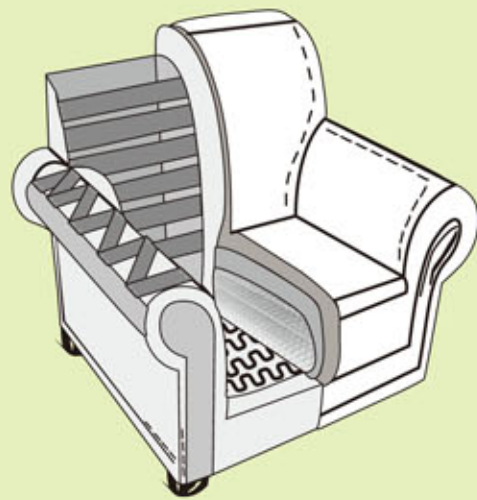

APPLICATIONS	TOOL SERIES	MODEL	PAGE	
Furniture Cabinets Bedding	Fine Wire Stapler	MT7116 7116 7116B 7116C	39, 43, 44, 45	
		MT8016 8016B 8016D 8016F	39, 45, 43, 44	
		1022J	46	
		422J	46	
		MT5016 MTP5016	39, 42	
		MT425J MT1025J	47	
		1416 1416B	43, 45	
		MT432KLM MT440KLM	48	
		Medium Wire Stapler	440KB	49
		9240B	49	
Cabinets	Headless Pinner Nailer	635TR	49	
		Heavy Wire Stapler	N851F MT-N851-HMT-N851-L	50, 51, 52
		PW2638-L	52	
		Coil Nailer	CN55 CN55B	8, 9
		CN55C CN55K	9, 10	
		Deco Nailer	ZN1400 ZN-12	69
		Brad Nailer	MTF32 F32 F32D F50C F50G	58, 59, 60
		T64A T50MA FST50	60, 61, 62	
		MP622 MP630	33, 34	
		MP635 MP650B	34, 35	
Mini Brad Pinner	MP840 MP850	35, 36		

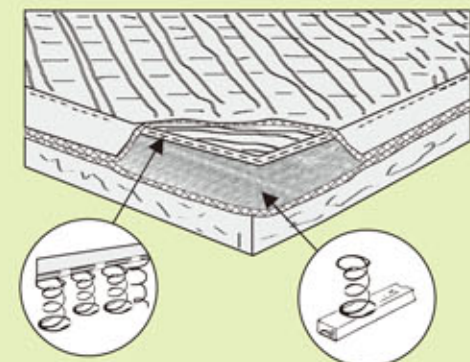

APPLICATIONS	TOOL SERIES	MODEL	PAGE	
Spring Mattress	C-Ring Plier	SC7C SC7C-P	24	
		SC7E SC7E-P	25	
		SC760B SC760C SC77XE	23, 26	
Car Seat	Clipping Tool	M66 M66L M65	28, 29	
		M46 M45	29	
Spring Mattress Car Seat	Fine Wire Stapler	Stapling Plier	P88U	27
		MT7116 7116 7116B 7116C	39, 43, 44, 45	
		MT8016 8016B 8016D 8016F	39, 45, 43, 44	
		1022J	46	
		422J	46	
		MT5016 MTP5016	39, 42	
		MT425J MT1025J	47	
		1416 1416B	43, 45	

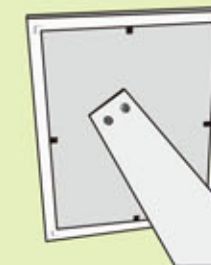

APPLICATIONS	TOOL SERIES	MODEL	PAGE	
Picture Frame	Flex Point Tacker	HM515	67	
		P515	67	
		Hard Point Tacker	HF18	68
		V-Nailer	V1015B	68
		Headless Pinner Nailer	MP622 MP630	33, 34
		MP635 MP650B	34, 35	
		Mini Brad Pinner	MP840 MP850	35, 36



## Construction Coil Nailer

### 15° COIL NAIL CN452S 2" Coil Nailer

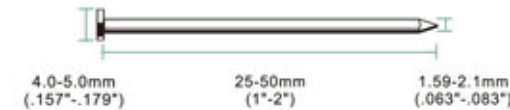

FEATURES
▶ Switchable firing mode
▶ 360° exhaust deflector
▶ Light weight & well-balanced
▶ Adjustable depth control
▶ No-mar tip

APPLICATIONS
▶ Siding
▶ Decking
▶ Fencing
▶ Sheathing

FASTENER
Type: Wire / Plastic Collated Coil Nails
Length: 25-50mm (1"-2")
Shank Dia.: 1.59-2.1mm (.062\"-.082")
Head Dia.: 4.0-5.0mm (.157\"-.179")
Nail Pitch: 6.0mm (.236")
Shank Type: Smooth, Screw & Ring

SIMILAR TOOLS
▶ MAX CN452S

TOOL SPECIFICATIONS			
Weight:	1.86kg/4.10lbs	Capacity:	Wire:400pcs/Plastic:200pcs
Height:	300mm/11.81"	Operating Pressure:	60-100psi
Length:	287mm/11.29"	Air Inlet:	1/4"NPT
Width:	110mm/4.33"	Trigger:	Contact

## Industrial Coil Nailer

### 15° COIL NAIL CN55 2 1/4" Coil Nailer

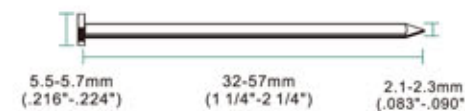

FEATURES
▶ Powerful for heavy-duty applications
▶ Well-balanced, comfort rubber grip
▶ Bump firing trigger for high speed operation
▶ Durable driver and bumper for long life
▶ Accurate nose, minimize nail jam

APPLICATIONS
▶ Pallets
▶ Crates & Wood Cases
▶ Sheathing
▶ Siding
▶ Fencing
▶ Decking

FASTENER
Type: Wire Collated Coil Nails
Length: 32-57mm (1 1/4"-2 1/4")
Shank Dia.: 2.1-2.3mm (.082\"-.090")
Head Dia.: 5.5-5.7mm (.216\"-.224")
Nail Pitch: 6.8mm (.267")
Shank Type: Smooth, Screw & Ring

SIMILAR TOOLS
▶ MAX CN55
▶ BeA 550DC
▶ Bostitch N57C
▶ SENCO Pallet Pro 57F

TOOL SPECIFICATIONS			
Weight:	2.75kg/6.06lbs	Capacity:	300-400pcs
Height:	283mm/11.14"	Operating Pressure:	70-100psi
Length:	270mm/10.62"	Air Inlet:	1/4"NPT
Width:	131mm/5.15"	Trigger:	Contact

**15°**  
COIL NAIL **CN55B**  
2 1/4" Coil Nailer / Extra Power

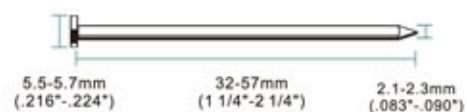

FEATURES	APPLICATIONS
<ul style="list-style-type: none"> <li>Powerful for heavy-duty applications</li> <li>Well-balanced, comfort rubber grip</li> <li>Bump firing trigger for high speed operation</li> <li>Durable driver and bumper for long life</li> <li>Accurate nose, minimize nail jam</li> </ul>	<ul style="list-style-type: none"> <li>Pallets</li> <li>Crates &amp; Wood Cases</li> <li>Sheathing</li> <li>Siding</li> <li>Fencing</li> <li>Decking</li> </ul>

FASTENER	SIMILAR TOOLS
Type: Wire Collated Coil Nails	MAX CN55
Length: 32-57mm(1 1/4"-2 1/4")	BeA 550DC
Shank Dia.: 2.1-2.3mm(.082"-.090")	Bostitch N57C
Head Dia.: 5.5-5.7mm(.216"-.224")	SENCO Pallet Pro 57F
Nail Pitch: 6.8mm(.267")	
Shank Type: Smooth, Screw & Ring	

TOOL SPECIFICATIONS			
Weight:	2.9kg/6.39lbs	Capacity:	300-400pcs
Height:	315mm/12.40"	Operating Pressure:	70-100psi
Length:	270mm/10.62"	Air Inlet:	1/4"NPT
Width:	131mm/5.15"	Trigger:	Contact

**15°**  
COIL NAIL **CN55C**  
2 1/4" Coil Nailer

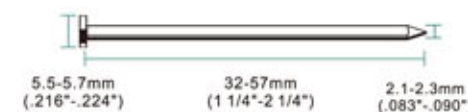

FEATURES	APPLICATIONS
<ul style="list-style-type: none"> <li>Powerful for heavy-duty applications</li> <li>Well-balanced, comfort rubber grip</li> <li>Bump firing trigger for high speed operation</li> <li>Durable driver and bumper for long life</li> <li>Accurate nose, minimize nail jam</li> </ul>	<ul style="list-style-type: none"> <li>Pallets</li> <li>Crates &amp; Wood Cases</li> <li>Sheathing</li> <li>Siding</li> <li>Fencing</li> <li>Decking</li> </ul>

FASTENER	SIMILAR TOOLS
Type: Wire Collated Coil Nails	MAX CN55
Length: 32-57mm(1 1/4"-2 1/4")	BeA 550DC
Shank Dia.: 2.1-2.3mm(.082"-.090")	Bostitch N57C
Head Dia.: 5.5-5.7mm(.216"-.224")	SENCO Pallet Pro 57F
Nail Pitch: 6.8mm(.267")	
Shank Type: Smooth, Screw & Ring	

TOOL SPECIFICATIONS			
Weight:	2.57kg/5.67lbs	Capacity:	300-400pcs
Height:	270mm/10.62"	Operating Pressure:	70-100psi
Length:	300mm/11.81"	Air Inlet:	1/4"NPT
Width:	135mm/5.31"	Trigger:	Contact

**15°**  
COIL NAIL **CN55K**  
2 1/4" Coil Nailer / Depth Control

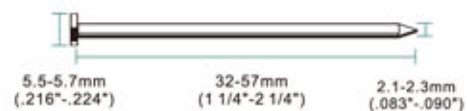

FEATURES	APPLICATIONS
<ul style="list-style-type: none"> <li>Powerful for heavy-duty applications</li> <li>Well-balanced, comfort rubber grip</li> <li>Bump firing trigger for high speed operation</li> <li>Durable driver and bumper for long life</li> <li>Accurate nose, minimize nail jam</li> </ul>	<ul style="list-style-type: none"> <li>Pallets</li> <li>Crates &amp; Wood Cases</li> <li>Sheathing</li> <li>Siding</li> <li>Fencing</li> <li>Decking</li> </ul>

FASTENER	SIMILAR TOOLS
Type: Wire Collated Coil Nails	MAX CN55
Length: 32-57mm(1 1/4"-2 1/4")	BeA 550DC
Shank Dia.: 2.1-2.3mm(.082"-.090")	Bostitch N57C
Head Dia.: 5.5-5.7mm(.216"-.224")	SENCO Pallet Pro 57F
Nail Pitch: 6.8mm(.267")	
Shank Type: Smooth, Screw & Ring	

TOOL SPECIFICATIONS			
Weight:	2.75kg/6.06lbs	Capacity:	300-400pcs
Height:	283mm/11.14"	Operating Pressure:	70-100psi
Length:	270mm/10.62"	Air Inlet:	1/4"NPT
Width:	131mm/5.15"	Trigger:	Contact

**15°**  
COIL NAIL **CN65B**  
2 1/2" Coil Nailer

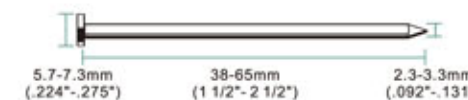

FEATURES	APPLICATIONS
<ul style="list-style-type: none"> <li>360° exhaust deflector</li> <li>Light weight and well-balanced</li> <li>Bump firing trigger for high speed operation</li> <li>Durable driver and bumper for long life</li> </ul>	<ul style="list-style-type: none"> <li>Pallets</li> <li>Crates &amp; Wood Cases</li> <li>Sheathing</li> <li>Siding</li> <li>Fencing</li> <li>Decking</li> </ul>

FASTENER	SIMILAR TOOLS
Type: Wire Collated Coil Nails	MAX CN665
Length: 38-65mm(1 1/2"-2 1/2")	
Shank Dia.: 2.3-3.3mm(.090"-.129")	
Head Dia.: 5.7-7.3mm(.224"-.287")	
Nail Pitch: 8mm(.314")	
Shank Type: Smooth, Screw & Ring	

TOOL SPECIFICATIONS			
Weight:	2.96kg/6.53lbs	Capacity:	300pcs
Height:	328mm/12.91"	Operating Pressure:	70-100psi
Length:	310mm/12.20"	Air Inlet:	1/4"NPT
Width:	130mm/5.11"	Trigger:	Contact

**15°**  
COIL NAIL  
**CN70B**  
2 3/4" Coil Nailer

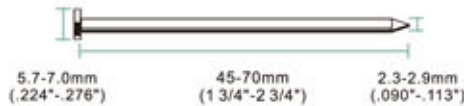

FEATURES	APPLICATIONS
<ul style="list-style-type: none"> <li>Powerful for heavy-duty applications</li> <li>Well-balanced, comfort rubber grip</li> <li>Bump firing trigger for high speed operation</li> <li>Durable driver and bumper for long life</li> <li>Accurate nose, minimize nail jam</li> </ul>	<ul style="list-style-type: none"> <li>Pallets</li> <li>Crates &amp; Wood Cases</li> <li>Framing</li> <li>Decking</li> <li>Fencing</li> <li>Packaging</li> </ul>

FASTENER	SIMILAR TOOLS
<b>Type:</b> Wire Collated Coil Nails <b>Length:</b> 45-70mm(1 3/4"-2 3/4") <b>Shank Dia.:</b> 2.3-2.9mm(.090"-.114") <b>Head Dia.:</b> 5.7-7.0mm(.224"-.275") <b>Nail Pitch:</b> 8mm(.314") <b>Shank Type:</b> Smooth, Screw & Ring	<ul style="list-style-type: none"> <li>MAX CN70</li> <li>Bostitch N70CB</li> <li>BeA 700DC</li> </ul>

TOOL SPECIFICATIONS			
<b>Weight:</b>	3.84kg/8.47lbs	<b>Capacity:</b>	225-300pcs
<b>Height:</b>	318mm/12.51"	<b>Operating Pressure:</b>	70-100psi
<b>Length:</b>	336mm/13.22"	<b>Air Inlet:</b>	1/4"NPT
<b>Width:</b>	143mm/5.62"	<b>Trigger:</b>	Contact

**15°**  
COIL NAIL  
**CN70C**  
2 3/4" Coil Nailer

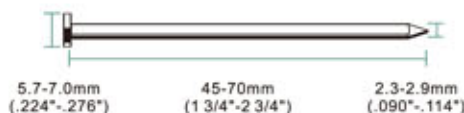

FEATURES	APPLICATIONS
<ul style="list-style-type: none"> <li>Powerful for heavy-duty applications</li> <li>Well-balanced, comfort rubber grip</li> <li>Bump firing trigger for high speed operation</li> <li>Durable driver and bumper for long life</li> <li>Accurate nose, minimize nail jam</li> </ul>	<ul style="list-style-type: none"> <li>Pallets</li> <li>Crates &amp; Wood Cases</li> <li>Framing</li> <li>Decking</li> <li>Fencing</li> <li>Packaging</li> </ul>

FASTENER	SIMILAR TOOLS
<b>Type:</b> Wire Collated Coil Nails <b>Length:</b> 45-70mm(1 3/4"-2 3/4") <b>Shank Dia.:</b> 2.3-2.9mm(.090"-.114") <b>Head Dia.:</b> 5.7-7.0mm(.224"-.275") <b>Nail Pitch:</b> 8mm(.314") <b>Shank Type:</b> Smooth, Screw & Ring	<ul style="list-style-type: none"> <li>MAX CN70</li> <li>Bostitch N70CB</li> <li>BeA 700DC</li> </ul>

TOOL SPECIFICATIONS			
<b>Weight:</b>	3.84kg/8.47lbs	<b>Capacity:</b>	225-300pcs
<b>Height:</b>	318mm/12.51"	<b>Operating Pressure:</b>	70-100psi
<b>Length:</b>	336mm/13.22"	<b>Air Inlet:</b>	1/4"NPT
<b>Width:</b>	143mm/5.62"	<b>Trigger:</b>	Contact

Tool Mounted on Automatic Pallet Machine

**15°**  
COIL NAIL  
**CN70E**  
2 3/4" Coil Nailer



**FEATURES**

- Tool for automatic pallet machine
- Powerful for heavy-duty applications
- Rapid firing trigger for high speed operation
- Durable driver and bumper for long life
- Accurate nose to minimize nail jam

**APPLICATIONS**

- Pallets

	FASTENER	
	CN70E	CN80E
<b>Type:</b>	Wire Collated Coil Nails	Wire Collated Coil Nails
<b>Length:</b>	45-70mm(1 3/4"-2 3/4")	45-83mm(1 3/4"-3 1/4")
<b>Shank Dia.:</b>	2.3-2.9mm(.090"-.114")	2.5-3.1mm(.098"-.122")
<b>Head Dia.:</b>	5.7-7.0mm(.224"-.275")	6.0-7.0mm(.236"-.275")
<b>Nail Pitch:</b>	8mm(.314")	8mm(.314")
<b>Shank Type:</b>	Smooth, Screw & Ring	Smooth, Screw & Ring

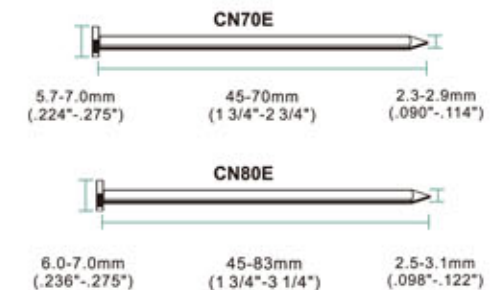

	TOOL SPECIFICATIONS	
	CN70E	CN80E
<b>Weight:</b>	3.05kg/6.72lbs	4.02kg/8.86lbs
<b>Height:</b>	318mm/12.51"	348mm/13.70"
<b>Length:</b>	338mm/13.30"	347mm/13.66"
<b>Width:</b>	112mm/4.40"	137mm/5.39"
<b>Capacity:</b>	3000pcs	3000pcs
<b>Operating Pressure:</b>	70-100psi	70-100psi
<b>Air Inlet:</b>	1/4"NPT	1/4"NPT
<b>Trigger:</b>	Remote Control	Remote Control



Secondary Safety Handle

15° COIL NAIL **CN70DS**  
2 3/4" Coil Nailer



**BOTH HANDS** REQUIRED  
FOR ACTUATION  
HELPS **MINIMIZE** ACCIDENTS



NO MORE

Also available:



FEATURES	APPLICATIONS
<ul style="list-style-type: none"> <li>Powerful for heavy-duty applications</li> <li>Well-balanced, comfort rubber grip</li> <li>Bump firing trigger for high speed operation</li> <li>Durable driver and bumper for long life</li> <li>Accurate nose, minimize nail jam</li> </ul>	<ul style="list-style-type: none"> <li>Pallets</li> <li>Crates &amp; Wood Cases</li> </ul>

FASTENER SPECIFICATIONS			
Model:	CN70DS	CN80DS	CN100DS
Type:	Wire Collated Coil Nails	Wire Collated Coil Nails	Wire Collated Coil Nails
Length:	45-70mm(1 3/4"-2 3/4")	45-83mm(1 3/4"-3 1/4")	65-100mm(2 1/2"-4")
Shank Dia.:	2.3-2.9mm(.090"-.114")	2.5-3.1mm(.098"-.122")	2.5-3.3mm(.098"-.129")
Head Dia.:	5.7-7.0mm(.224"-.275")	6.0-7.0mm(.236"-.275")	6.2-7.2mm(.244"-.283")
Nail Pitch:	8mm(.314")	8mm(.314")	8mm(.314")
Shank Type:	Smooth,Screw & Ring	Smooth,Screw & Ring	Smooth,Screw & Ring

TOOL SPECIFICATIONS			
Model:	CN70DS	CN80DS	CN100DS
Weight:	4.02kg/8.86lbs	4.34kg/9.57lbs	5.67kg/12.5lbs
Height:	318mm/12.51"	348mm/13.70"	420mm/16.53"
Length:	376mm/14.80"	347mm/13.66"	370mm/14.56"
Width:	133mm/5.23"	137mm/5.39"	159mm/6.25"
Capacity:	Wire:225-300pcs	Wire:225-300pcs	Wire:225-300pcs
Operating Pressure:	70-100psi	70-100psi	100-120psi
Air Inlet:	1/4"NPT	1/4"NPT	3/8"NPT
Trigger:	Contact	Contact	Contact

15° COIL NAIL **CN80B**  
3 1/4" Coil Nailer

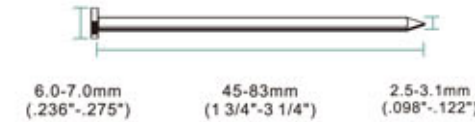

FEATURES	APPLICATIONS
<ul style="list-style-type: none"> <li>Powerful for heavy-duty applications</li> <li>Well-balanced, comfort rubber grip</li> <li>Bump firing trigger for high speed operation</li> <li>Durable driver and bumper for long life</li> <li>Accurate nose, minimize nail jam</li> </ul>	<ul style="list-style-type: none"> <li>Pallets</li> <li>Crates &amp; Wood Cases</li> <li>Packaging</li> <li>Decking</li> <li>Sheathing</li> </ul>

FASTENER		SIMILAR TOOLS	
Type:	Wire Collated Coil Nails	<ul style="list-style-type: none"> <li>MAX CN80</li> <li>Bostitch N80CB</li> <li>BeA 800DC</li> </ul>	
Length:	45-83mm(1 3/4"-3 1/4")		
Shank Dia.:	2.5-3.1mm(.098"-.122")		
Head Dia.:	6.0-7.0mm(.236"-.275")		
Nail Pitch:	8mm(.314")		
Shank Type:	Smooth, Screw & Ring		

TOOL SPECIFICATIONS			
Weight:	4.02kg/8.86lbs	Capacity:	225-300pcs
Height:	348mm/13.70"	Operating Pressure:	70-100psi
Length:	347mm/13.66"	Air Inlet:	1/4"NPT
Width:	137mm/5.39"	Trigger:	Contact

15° COIL NAIL **CN90**  
3 1/2" Coil Nailer

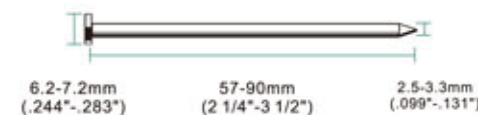

FEATURES	APPLICATIONS
<ul style="list-style-type: none"> <li>Powerful for heavy-duty applications</li> <li>Rubber comfort grip</li> <li>Well-balanced, light weight</li> <li>Downward directional exhaust</li> <li>Durable driver and bumper for long life</li> </ul>	<ul style="list-style-type: none"> <li>Pallets</li> <li>Crates Wood Cases</li> <li>Packaging</li> <li>Decking</li> <li>Sheathing</li> </ul>

FASTENER		SIMILAR TOOLS	
Type:	Wire Collated Coil Nails	<ul style="list-style-type: none"> <li>Bostitch N89C</li> <li>BeA 904DC</li> <li>SENCO Pallet Pro 90</li> </ul>	
Length:	57-90mm(2 1/4"-3 1/2")		
Shank Dia.:	2.5-3.3mm(.098"-.129")		
Head Dia.:	6.2-7.2mm(.244"-.283")		
Nail Pitch:	8mm(.314")		
Shank Type:	Smooth, Screw & Ring		

TOOL SPECIFICATIONS			
Weight:	4.13kg/9.11lbs	Capacity:	225-300pcs
Height:	365mm/14.37"	Operating Pressure:	100-120psi
Length:	385mm/15.15"	Air Inlet:	3/8"NPT
Width:	137mm/5.39"	Trigger:	Contact



**15°**  
COIL NAIL **CN100B**  
4" Coil Nailer

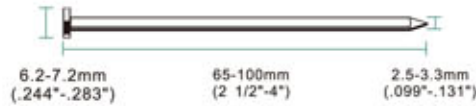

FEATURES	APPLICATIONS
▶ Powerful for heavy-duty applications	▶ Pallets
▶ Well-balanced when hung on balancer	▶ Crates Wood Cases
▶ Rubber comfort grip	▶ Packaging
▶ Downward directional exhaust	▶ Decking
▶ Durable driver and bumper for long life	▶ Sheathing

FASTENER	SIMILAR TOOLS
<b>Type:</b> Wire Collated Coil Nails	▶ Senco Pallet Pro 100
<b>Length:</b> 65-100mm(2 1/2"-4")	▶ Bostitch N400C
<b>Shank Dia.:</b> 2.5-3.3mm(.099"-.131")	▶ MAX CN100
<b>Head Dia.:</b> 6.2-7.2mm(.244"-.283")	
<b>Nail Pitch:</b> 10.5mm(.413")	
<b>Shank Type:</b> Smooth, Screw & Ring	

TOOL SPECIFICATIONS			
<b>Weight:</b>	5.67kg/12.5lbs	<b>Capacity:</b>	225-300pcs
<b>Height:</b>	420mm/16.53"	<b>Operating Pressure:</b>	100-120psi
<b>Length:</b>	370mm/14.56"	<b>Air Inlet:</b>	3/8"NPT
<b>Width:</b>	159mm/6.25"	<b>Trigger:</b>	Contact



Premium  
**EPAL**  
Coil Nailer  
For Professionals

**15°**  
COIL NAIL **CN100**  
4" Coil Nailer

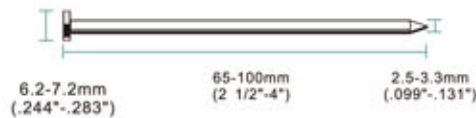

FEATURES	APPLICATIONS
▶ Powerful for heavy-duty applications	▶ Pallets
▶ Well-balanced when hung on balancer	▶ Crates Wood Cases
▶ Rubber comfort grip	▶ Packaging
▶ Downward directional exhaust	▶ Decking
▶ Durable driver and bumper for long life	▶ Sheathing

FASTENER	SIMILAR TOOLS
<b>Type:</b> Wire Collated Coil Nails	▶ Senco Pallet Pro 100
<b>Length:</b> 65-100mm(2 1/2"-4")	▶ Bostitch N400C
<b>Shank Dia.:</b> 2.5-3.3mm(.099"-.131")	▶ MAX CN100
<b>Head Dia.:</b> 6.2-7.2mm(.244"-.283")	
<b>Nail Pitch:</b> 10.5mm(.413")	
<b>Shank Type:</b> Smooth, Screw & Ring	

TOOL SPECIFICATIONS			
<b>Weight:</b>	5.82kg/12.83lbs	<b>Capacity:</b>	225-300pcs
<b>Height:</b>	403mm/15.86"	<b>Operating Pressure:</b>	100-120psi
<b>Length:</b>	405mm/15.94"	<b>Air Inlet:</b>	3/8"NPT
<b>Width:</b>	143mm/5.62"	<b>Trigger:</b>	Contact

**15°**  
COIL NAIL **CN100EPAL**  
3 1/2" Coil Nailer

FEATURES
▶ Drives PAL Coil nails from 70-90mm
▶ Powerful for heavy-duty applications
▶ Well-balanced when hung on balancer
▶ Rubber comfort grip
▶ Downward directional exhaust
▶ Durable driver and bumper for long life

APPLICATIONS
▶ EPAL Pallets
▶ Heavy-duty pallets
▶ Packaging

FASTENER
<b>Type:</b> Wire Collated Coil Nails
<b>Length:</b> 70&90mm(2 3/4"&3 1/2")
<b>Shank Dia.:</b> 3.5mm(.138")
<b>Head Dia.:</b> 8.6mm(.338")
<b>Nail Pitch:</b> 10.5mm(.413")
<b>Shank Type:</b> Smooth, Screw & Ring

SIMILAR TOOLS
▶ Senco Pallet Pro 100
▶ Bostitch N400C
▶ MAX CN100EPAL

TOOL SPECIFICATIONS			
<b>Weight:</b>	5.8kg/12.79lbs	<b>Capacity:</b>	225-300pcs
<b>Height:</b>	336mm/13.22"	<b>Operating Pressure:</b>	100-120psi
<b>Length:</b>	457mm/17.99"	<b>Air Inlet:</b>	3/8"NPT
<b>Width:</b>	156mm/6.14"	<b>Trigger:</b>	Contact

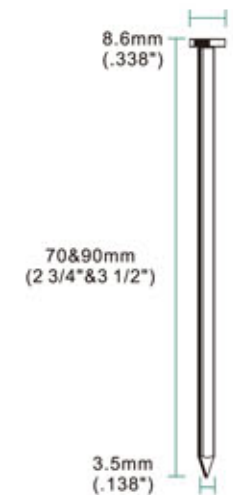

## Industrial Coil Nailer

meite®

15°  
COIL NAIL

**CN130**  
5 1/8" Coil Nailer

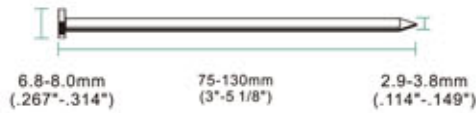

FEATURES	APPLICATIONS
▶ Powerful for heavy-duty applications	▶ Pockaging
▶ Well-balanced when hung on balancer	▶ Pallets
▶ Rubber comfort grip	▶ Crates & Wood Cases
▶ Downward directional exhaust	▶ Framing
▶ Durable driver and bumper for long life	

FASTENER	SIMILAR TOOLS
Type: Wire Collated Coils Nails	▶ SENCO Pallet Pro 130
Length: 75-130mm(3"-5 1/8")	
Shank Dia.: 2.9-3.8mm(.114"-.149")	
Head Dia.: 6.8-8.0mm(.267"-.314")	
Nail Pitch: 10.5mm(.413")	
Shank Type: Smooth, Screw & Ring	

TOOL SPECIFICATIONS			
Weight:	6.51kg/14.35lbs	Capacity:	120-225pcs
Height:	479mm/18.85"	Operating Pressure:	100-120psi
Length:	370mm/14.56"	Air Inlet:	3/8"NPT
Width:	165mm/6.49"	Trigger:	Contact

## Industrial Strip Nailer

21°  
STRIP NAIL

**SF13021**  
5 1/8" Strip Nailer

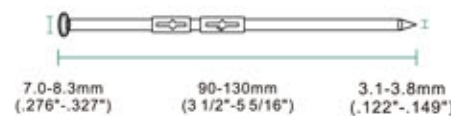

FEATURES	APPLICATIONS
▶ Powerful for heavy-duty applications	▶ Packaging
▶ Well-balanced	▶ Pallets
▶ Rubber comfort grip	▶ Crates & Wood Cases
▶ Durable driver and bumper for long life	▶ Framing
▶ Second handle is included	

FASTENER	SIMILAR TOOLS
Type: Plastic Collated Strip Nails	▶ REICH F3535
Head Type: Full round head	
Length: 90-130mm(3 1/2"-5 5/16")	
Shank Dia.: 3.1-3.8mm(.122"-.149")	
Head Dia.: 7.0-8.3mm(.276"-.327")	

TOOL SPECIFICATIONS			
Weight:	6.76kg/14.9lbs	Capacity:	30pcs
Height:	463mm/18.22"	Operating Pressure:	100-120psi
Length:	528mm/20.78"	Air Inlet:	3/8"NPT
Width:	153mm/6.02"	Trigger:	Contact

NAIL REMOVING



DRIVES NAILS FROM THE POINT  
FOR REMOVING IN WOOD

## T50SC De-Nailer



FEATURES		APPLICATIONS	
▶ Tool for pallet repairing		▶ Pallets	
▶ Light weight & well-balanced		▶ Crates & Wood Cases	
▶ Rubber comfort grip		▶ Packaging	
▶ Durable driver and bumper for long life			

TOOL SPECIFICATIONS			
<b>Weight:</b>	1.06kg/2.34lbs	<b>Capacity:</b>	/
<b>Height:</b>	228mm/8.97"	<b>Operating Pressure:</b>	60-100psi
<b>Length:</b>	282mm/11.10"	<b>Air Inlet:</b>	1/4"NPT
<b>Width:</b>	62mm/2.44"	<b>Trigger:</b>	Trigger

## NP55 De-Nailer



FEATURES		APPLICATIONS	
▶ Tool for pallet repairing		▶ Pallets	
▶ Light weight & well-balanced		▶ Crates & Wood Cases	
▶ Rubber comfort grip		▶ Packaging	
▶ Durable driver and bumper for long life			
▶ Powerful for heavy-duty applications			

TOOL SPECIFICATIONS			
<b>Weight:</b>	2.0kg/4.41lbs	<b>Capacity:</b>	/
<b>Height:</b>	276mm/1086"	<b>Operating Pressure:</b>	60-100psi
<b>Length:</b>	298mm/11.73"	<b>Air Inlet:</b>	1/4"NPT
<b>Width:</b>	88mm/3.46"	<b>Trigger:</b>	Trigger

## NP70 De-Nailer



FEATURES		APPLICATIONS	
▶ Tool for pallet repairing		▶ Pallets	
▶ Light weight & well-balanced		▶ Crates & Wood Cases	
▶ Rubber comfort grip		▶ Packaging	
▶ Durable driver and bumper for long life			
▶ Powerful for heavy-duty applications			

TOOL SPECIFICATIONS			
<b>Weight:</b>	2.73kg/6.02lbs	<b>Capacity:</b>	/
<b>Height:</b>	109mm/4.29"	<b>Operating Pressure:</b>	85-115psi
<b>Length:</b>	343mm/13.50"	<b>Air Inlet:</b>	1/4"NPT
<b>Width:</b>	303mm/11.92"	<b>Trigger:</b>	Trigger

# WIRE COLLATED COIL NAILS



Coil Roofing Nails



NAIL SPECIFICATIONS					
MODEL	LENGTH	DIAMETER	FINISH	PCS	BOX
32mm	1 1/4"(32mm)	.120"(3mm)	Galv.	7200	1
38mm	1 1/2"(38mm)	.120"(3mm)	Galv.	7200	1

Coil Nails



NAIL SPECIFICATIONS					
MODEL	SIZE	DIAMETER	FINISH	BOX / QTY	BOX / CTN
2125	1"(25mm)	.083"(2.1mm)	Coating	20000	1
2127	1 1/8"(27mm)	.083"(2.1mm)	Coating	20000	1
2128	1 1/8"(28mm)	.083"(2.1mm)	Coating	16000	1
2132	1 1/4"(32mm)	.083"(2.1mm)	Coating	16000	1
2135	1 3/8"(35mm)	.083"(2.1mm)	Coating	16000	1
2138	1 1/2"(38mm)	.083"(2.1mm)	Coating	16000	1
2140	1 9/16"(40mm)	.083"(2.1mm)	Coating	16000	1
2145	1 3/4"(45mm)	.083"(2.1mm)	Coating	12000	1
2150	2"(50mm)	.083"(2.1mm)	Coating	12000	1
2155	2 1/8"(55mm)	.083"(2.1mm)	Coating	12000	1
2157	2 1/4"(55mm)	.083"(2.1mm)	Coating	12000	1
2345	1 3/4"(45mm)	.091"(2.3mm)	Coating	9000	1
2350B	2"(50mm)	.091"(2.3mm)	Coating	9000	1
2355	2 1/8"(55mm)	.091"(2.3mm)	Coating	9000	1
2357B	2 1/4"(57mm)	.091"(2.3mm)	Coating	9000	1
2360	2 3/8"(60mm)	.091"(2.3mm)	Coating	9000	1
2364	2 1/2"(64mm)	.091"(2.3mm)	Coating	9000	1
2545	1 3/4"(45mm)	.098"(2.5mm)	Coating	9000	1
2550	2"(50mm)	.098"(2.5mm)	Coating	9000	1
2557	2 1/4"(57mm)	.098"(2.5mm)	Coating	9000	1
2560	2 3/8"(60mm)	.098"(2.5mm)	Coating	9000	1
2564	2 1/2"(64mm)	.098"(2.5mm)	Coating	9000	1

NAIL SPECIFICATIONS					
MODEL	SIZE	DIAMETER	FINISH	BOX / QTY	BOX / CTN
2570	2 3/4"(70mm)	.098"(2.5mm)	Coating	6000	1
2575	3"(75mm)	.098"(2.5mm)	Coating	6000	1
2580	3 1/8"(80mm)	.098"(2.5mm)	Coating	6000	1
2970	2 3/4"(70mm)	.114"(2.9mm)	Coating	4500	1
2976	3"(76mm)	.114"(2.9mm)	Coating	4500	1
2980	3 1/8"(80mm)	.114"(2.9mm)	Coating	4500	1
2990	3 1/2"(90mm)	.114"(2.9mm)	Coating	4500	1
29100	4"(100mm)	.114"(2.9mm)	Coating	2700	1
3170	2 3/4"(70mm)	.122"(3.1mm)	Coating	2700	1
3175	3"(75mm)	.122"(3.1mm)	Coating	2700	1
3180	3 1/8"(80mm)	.122"(3.1mm)	Coating	2700	1
3190	3 1/2"(90mm)	.122"(3.1mm)	Coating	2700	1
3195	3 3/4"(95mm)	.122"(3.1mm)	Coating	2700	1
31100	4"(100mm)	.122"(3.1mm)	Coating	2700	1
31110	3 1/2"(90mm)	.122"(3.1mm)	Coating	2700	1
31120	4 13/16"(120mm)	.122"(3.1mm)	Coating	2700	1
3483	3 1/4"(38mm)	.130"(3.3mm)	Coating	2700	1
3490	3 1/2"(90mm)	.130"(3.3mm)	Coating	2700	1
3495	3 3/4"(95mm)	.130"(3.3mm)	Coating	2700	1
34100	4"(100mm)	.130"(3.3mm)	Coating	2700	1
34120	4 13/16"(120mm)	.130"(3.3mm)	Coating	2700	1
38130	5 3/16"(64mm)	.156"(3.8mm)	Coating	1440	1

MATTRESS & CAR SEAT



MATTRESS & CAR SEAT

**16<sup>GA</sup>**  
C-RING  
**SC760B**  
1/2" C-Ring Plier



STEEL  
MAGAZINE



FEATURES	APPLICATIONS
▶ Well-balanced, ergonomically designed	▶ Wire Cage
▶ Large capacity long magazine	▶ Car Seat
▶ Rubber comfort grip	▶ Spring Mattress
▶ Can be easily converted to right or left hand operation	▶ Bag Closure

FASTENER	SIMILAR TOOLS
Type: Tape Collated C-Ring	▶ Bostitch SC760
Gauge Size: 16GA	▶ MEIHO MC-660
Wire Dia.: 1.6mm(.063")	
Inner Crown: 12.5mm(1/2")	
Closure Dia: 2.6-3.6mm(.102"-.141")	
Material: Galvanized, Aluminum, Stainless	

TOOL SPECIFICATIONS			
Weight:	1.63kg/3.59lbs	Capacity:	100pcs
Height:	201mm/7.91"	Operating Pressure:	70-100psi
Length:	330mm/12.99"	Air Inlet:	1/4"NPT
Width:	84mm/3.30"	Trigger:	Trigger

**15<sup>GA</sup>**  
C-RING  
**SC7C**  
3/4" C-Ring Plier



STEEL  
MAGAZINE

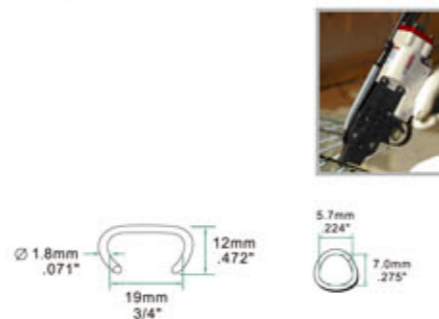

FEATURES	APPLICATIONS
▶ Well-balanced, ergonomically designed	▶ Wire Cage
▶ Large capacity long magazine	▶ Car Seat
▶ Rubber comfort grip	▶ Spring Mattress
▶ Can be easily converted to right or left hand operation	▶ Bag Closure

FASTENER	SIMILAR TOOLS
Type: Tape Collated C-Ring	▶ Bostitch SC7C
Gauge Size: 15GA	▶ MEIHO MC-6CA
Wire Dia.: 1.8mm(.070")	
Inner Crown: 19mm(3/4")	
Closure Dia: 5.7-7.0mm(.224"-.275")	
Material: Galvanized, Aluminum, Stainless	

TOOL SPECIFICATIONS			
Weight:	1.68kg/3.70lbs	Capacity:	100pcs
Height:	201mm/7.91"	Operating Pressure:	70-100psi
Length:	338mm/13.30"	Air Inlet:	1/4"NPT
Width:	84mm/3.30"	Trigger:	Trigger

MATTRESS & CAR SEAT

**16<sup>GA</sup>**  
C-RING  
**SC760C**  
1/2" C-Ring Plier

**NEW**



STEEL  
MAGAZINE

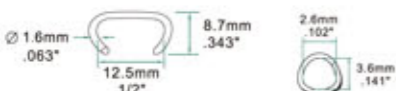

FEATURES	APPLICATIONS
▶ Light weight	▶ Wire Cage
▶ Well-balanced, ergonomically designed	▶ Car Seat
▶ Large capacity long magazine	▶ Spring Mattress
▶ Rubber comfort grip	▶ Bag Closure
▶ Can be easily converted to right or left hand operation	
▶ Carved jaw with longer life	

FASTENER	SIMILAR TOOLS
Type: Tape Collated C-Ring	▶ Bostitch SC760
Gauge Size: 16GA	▶ MEIHO MC-660
Wire Dia.: 1.6mm(.063")	
Inner Crown: 12.5mm(1/2")	
Closure Dia: 2.6-3.6mm(.102"-.141")	
Material: Galvanized, Aluminum, Stainless	

TOOL SPECIFICATIONS			
Weight:	1.57kg/3.46lbs	Capacity:	100pcs
Height:	201mm/7.91"	Operating Pressure:	70-100psi
Length:	300mm/11.81"	Air Inlet:	1/4"NPT
Width:	84mm/3.30"	Trigger:	Trigger

**15<sup>GA</sup>**  
C-RING  
**SC7C-P**  
3/4" C-Ring Plier

**NEW**



PLASTIC  
MAGAZINE



FEATURES	APPLICATIONS
▶ Light weight, plastic magazine	▶ Wire Cage
▶ Well-balanced, ergonomically designed	▶ Car Seat
▶ Large capacity long magazine	▶ Spring Mattress
▶ Rubber comfort grip	▶ Bag Closure
▶ Can be easily converted to right or left hand operation	

FASTENER	SIMILAR TOOLS
Type: Tape Collated C-Ring	▶ Bostitch SC7C
Gauge Size: 15GA	▶ MEIHO MC-6CA
Wire Dia.: 1.8mm(.070")	
Inner Crown: 19mm(3/4")	
Closure Dia: 5.7-7.0mm(.224"-.275")	
Material: Galvanized, Aluminum, Stainless	

TOOL SPECIFICATIONS			
Weight:	1.47kg/3.24lbs	Capacity:	100pcs
Height:	201mm/7.91"	Operating Pressure:	70-100psi
Length:	330mm/12.99"	Air Inlet:	1/4"NPT
Width:	84mm/3.30"	Trigger:	Trigger

MATTRESS & CAR SEAT

15<sup>GA</sup>  
C-RING

**SC7E**  
3/4" C-Ring Plier  
Extended Nose



STEEL  
MAGAZINE



FEATURES	APPLICATIONS
Well-balanced, ergonomically designed	Wire Cage
Large capacity long magazine	Car Seat
Rubber comfort grip	Spring Mattress
Can be easily converted to right or left hand operation	Bag Closure

FASTENER	SIMILAR TOOLS
Type: Tape Collated C-Ring	BEA CL24
Gauge Size: 15GA	Bostitch SC7E
Wire Dia.: 1.8mm(.070")	MEIHO MC-6LNA
Inner Crown: 19mm(3/4")	
Closure Dia: 8.8mm(.346")	
Material: Galvanized, Aluminum, Stainless	

TOOL SPECIFICATIONS			
Weight:	1.74kg/3.84lbs	Capacity:	100pcs
Height:	201mm/7.91"	Operating Pressure:	70-100psi
Length:	349mm/13.74"	Air Inlet:	1/4"NPT
Width:	84mm/3.30"	Trigger:	Trigger

15<sup>GA</sup>  
C-RING

**SC77XE**  
3/4" C-Ring Plier  
Extra Extended Nose



EXTRA  
NOSE



FEATURES	APPLICATIONS
Well-balanced, ergonomically designed	Wire Cage
Large capacity long magazine	Car Seat
Rubber comfort grip	Spring Mattress
Can be easily converted to right or left hand operation	Bag Closure

FASTENER	SIMILAR TOOLS
Type: Tape Collated C-Ring	Bostitch SC77XE
Gauge Size: 15GA	
Wire Dia.: 1.8mm(.070")	
Inner Crown: 19mm(3/4")	
Closure Dia: 8.8mm(.346")	
Material: Galvanized, Aluminum, Stainless	

TOOL SPECIFICATIONS			
Weight:	1.815kg/4.0lbs	Capacity:	100pcs
Height:	216mm/8.50"	Operating Pressure:	70-100psi
Length:	375mm/14.76"	Air Inlet:	1/4"NPT
Width:	88mm/3.46"	Trigger:	Trigger

MATTRESS & CAR SEAT

15<sup>GA</sup>  
C-RING

**SC7E-P**  
3/4" C-Ring Plier  
Extended Nose

NEW



PLASTIC  
MAGAZINE



FEATURES	APPLICATIONS
Light weight, plastic magazine	Wire Cage
Well-balanced, ergonomically designed	Car Seat
Large capacity long magazine	Spring Mattress
Rubber comfort grip	Bag Closure
Can be easily converted to right or left hand operation	

FASTENER	SIMILAR TOOLS
Type: Tape Collated C-Ring	BEA CL24
Gauge Size: 15GA	Bostitch SC7E
Wire Dia.: 1.8mm(.070")	MEIHO MC-6LNA
Inner Crown: 19mm(3/4")	
Closure Dia: 8.8mm(.346")	
Material: Galvanized, Aluminum, Stainless	

TOOL SPECIFICATIONS			
Weight:	1.53kg/3.37lbs	Capacity:	100pcs
Height:	201mm/7.91"	Operating Pressure:	70-100psi
Length:	355mm/13.97"	Air Inlet:	1/4"NPT
Width:	84mm/3.30"	Trigger:	Trigger

Reference Chart for C-Ring Plier

Model	Nose Length	Wire Diameter	Weight	Magazine Material	Capacity	Appearance
SC760B	Standard Nose	16GA	1.63KG	Steel	100PCS	
SC760C		16GA	1.57KG	Steel	100PCS	
SC7C	Standard Nose	15GA	1.68KG	Steel	100PCS	
SC7C-P		15GA	1.47KG	Plastic	100PCS	
SC7E	Extended Nose	15GA	1.74KG	Steel	100PCS	
SC7E-P		15GA	1.53KG	Plastic	100PCS	
SC77XE	Extra Extended Nose	15GA	1.815KG	Steel	100PCS	

**11 GA**  
C-RING  
**MT-HC45**  
1 1/2" Manual C-Ring Plier

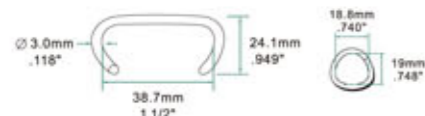

FEATURES	APPLICATIONS
<ul style="list-style-type: none"> <li>Well-balanced, ergonomically designed</li> <li>Convenient to use, no compressed air is needed</li> <li>Rubber comfort grip</li> </ul>	<ul style="list-style-type: none"> <li>Gabion</li> <li>Wire Cage</li> <li>Fencing</li> </ul>

FASTENER	SIMILAR TOOLS
<b>Type:</b> Tape Collated C-Ring <b>Gauge Size:</b> 11GA <b>Wire Dia.:</b> 3mm(.118") <b>Inner Crown:</b> 38.7mm(1 1/2") <b>Closure Dia:</b> 18.8-19mm(.740"-.748") <b>Material:</b> Galvanized, Aluminum, Stainless	<ul style="list-style-type: none"> <li>Bostitch HFP9</li> </ul>

TOOL SPECIFICATIONS			
<b>Weight:</b>	4.31kg/9.50lbs	<b>Capacity:</b>	45pcs
<b>Height:</b>	165mm/6.49"	<b>Operating Pressure:</b>	/
<b>Length:</b>	673mm/26.49"	<b>Air Inlet:</b>	/
<b>Width:</b>	125mm/4.92"	<b>Trigger:</b>	Manual

**M66L**  
Clipper



**APPLICATIONS**

- Wire Cage
- Spring Mattress
- Car Seat



**40%** lighter than traditional models

CLIPS SPECIFICATIONS					
Model	Crown	Height	Width	Thickness	Type
CL-3	6.2mm	12.3mm	22mm	0.8mm	Strip
CL-4	6.2mm	14.1mm	22mm	0.8mm	Strip
CL-5	6.2mm	15.5mm	19mm	0.8mm	Strip
CL-71	6.2mm	12.3mm	19mm	0.8mm	Strip
CL-72	6.2mm	14.1mm	19mm	0.8mm	Strip

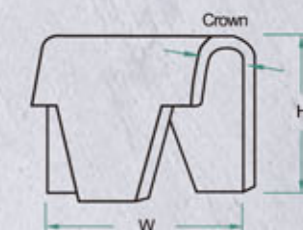

TOOL SPECIFICATIONS			
<b>Weight:</b>	2.25kg/4.96lbs	<b>Capacity:</b>	37pcs
<b>Height:</b>	173mm/6.81"	<b>Operating Pressure:</b>	85-115psi
<b>Length:</b>	426mm/16.77"	<b>Air Inlet:</b>	1/4"NPT
<b>Width:</b>	102mm/4.01"	<b>Trigger:</b>	Trigger



Industrial Stapling Plier

**20 GA**  
FINE WIRE  
STAPLE  
**P88U**  
1/2" Crown  
Stapling Plier

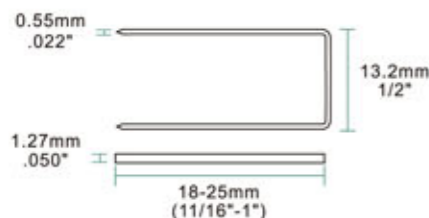

FEATURES	APPLICATIONS
<ul style="list-style-type: none"> <li>High-speed operation</li> <li>Detachable magazine for quick jam clearing</li> <li>Second safety trigger</li> <li>Rubber comfort grip</li> </ul>	<ul style="list-style-type: none"> <li>Spring Bedding</li> <li>Furniture</li> </ul>

FASTENER	SIMILAR TOOLS
<b>Type:</b> 88 Series Staples <b>Crown:</b> 13.2mm(.519") <b>Width:</b> 1.27(.050") <b>Thickness:</b> 0.55mm(.022") <b>Length:</b> 18-25mm(3/4"-1") <b>Collation Type:</b> Glued Strip	<ul style="list-style-type: none"> <li>Bostitch P88-SJ-E</li> <li>Omer P88SJ</li> </ul>

TOOL SPECIFICATIONS			
<b>Weight:</b>	2.18kg/4.81lbs	<b>Capacity:</b>	200pcs
<b>Height:</b>	303mm/11.92"	<b>Operating Pressure:</b>	70-100psi
<b>Length:</b>	362mm/14.25"	<b>Air Inlet:</b>	1/4"NPT
<b>Width:</b>	80mm/3.14"	<b>Trigger:</b>	Trigger

## M66B / M65B / M46B / M45B

Clipper

ALUMINUM HOUSING

STEEL MAGAZINE



### FEATURES

- Well-balanced, ergonomically designed
- Powerful motor for high speed operation
- Durable blade and anvil for long life
- Low maintenance

### APPLICATIONS

- Wire Cage
- Spring Mattress
- Car Seat

### SIMILAR TOOLS

- Bostitch HR-45
- Vertex Pro Clinch 45

### CLIPS SPECIFICATIONS

Tool	Model	Crown	Height	Width	Thickness	Type
M66B	CL-3	6.2mm	12.3mm	22mm	0.8mm	Strip
	CL-4	6.2mm	14.1mm	22mm	0.8mm	Strip
	CL-5	6.2mm	15.5mm	19mm	0.8mm	Strip
	CL-71	6.2mm	12.3mm	19mm	0.8mm	Strip
	CL-72	6.2mm	14.1mm	19mm	0.8mm	Strip
M65B	CL-23	4.8mm	12.7mm	22mm	0.8mm	Strip
	CL-24	4.8mm	15.5mm	22mm	0.8mm	Strip
	CL-73	4.8mm	12.7mm	19mm	0.8mm	Strip
	CL-74	4.8mm	15.5mm	19mm	0.8mm	Strip
M46B	CL-12	6.2mm	11.0mm	11mm	0.8mm	Strip
	CL-14	6.2mm	12.7mm	11mm	0.8mm	Strip
	CL-16	6.2mm	15.0mm	11mm	0.8mm	Strip
M45B	CL-18	6.2mm	13.3mm	11mm	0.8mm	Strip
	CL-13	4.8mm	10.7mm	11mm	0.8mm	Strip
	CL-15	4.8mm	9.9mm	11mm	0.8mm	Strip
	CL-17	4.8mm	10.0mm	11mm	0.8mm	Strip

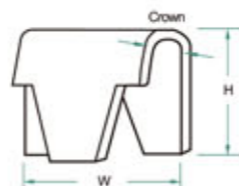

### TOOL SPECIFICATIONS

Model:	M66B	M65B	M46B	M45B
Weight:	3.21kg/7.08lbs	3.1kg/6.83lbs	3.0kg/6.61lbs	3.01kg/6.64lbs
Height:	200mm/7.87"	200mm/7.87"	200mm/7.87"	200mm/7.87"
Length:	450mm/17.71"	450mm/17.71"	450mm/17.71"	450mm/17.71"
Width:	95mm/3.74"	95mm/3.74"	95mm/3.74"	95mm/3.74"
Capacity:	37pcs	45pcs	37pcs	45pcs
Operating Pressure:	85-115psi	85-115psi	85-115psi	85-115psi
Air Inlet:	1/4"NPT	1/4"NPT	1/4"NPT	1/4"NPT
Trigger:	Trigger	Trigger	Trigger	Trigger

# C-RINGS & CLIPS SERIES





15<sup>GA</sup>  
C-RING

16<sup>GA</sup>  
C-RING

C-Ring Series



C-RING SPECIFICATIONS						
MODEL	A	B	C	D	PCS	BOX
SC7	.071"(1.8mm)	3/4"(19mm)	.472"(12mm)	.189"-.315"(4.8-8mm)	10000	4
SC760	.063"(1.6mm)	1/2"(12.5mm)	.343"(8.7mm)	.126"-.189"(3.2-4.8mm)	18000	4
C56	.079"(2.0mm)	1 1/2"(39mm)	3/4"(20mm)	.590"-.709"(15-18mm)	10000	1
C60	.079"(2.0mm)	2 1/4"(56mm)	3/4"(20mm)	.787"-.984"(20-25mm)	10000	1

Clips Series

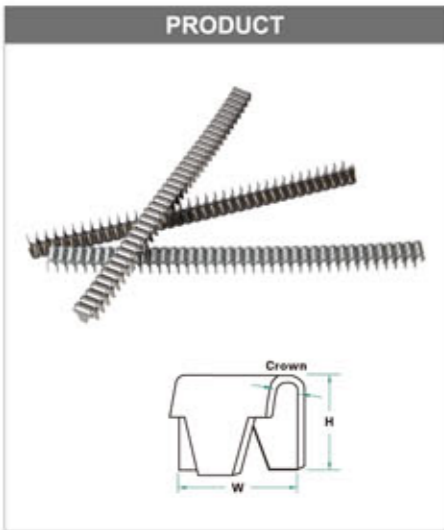

CLIPS SPECIFICATIONS						
Tool	Model	Crown	Height	Width	Thickness	Type
M66B	CL-3	6.2mm	12.3mm	22mm	0.8mm	Strip
	CL-4	6.2mm	14.1mm	22mm	0.8mm	Strip
	CL-5	6.2mm	15.5mm	19mm	0.8mm	Strip
	CL-71	6.2mm	12.3mm	19mm	0.8mm	Strip
	CL-72	6.2mm	14.1mm	19mm	0.8mm	Strip
M65B	CL-23	4.8mm	12.7mm	22mm	0.8mm	Strip
	CL-24	4.8mm	15.5mm	22mm	0.8mm	Strip
	CL-73	4.8mm	12.7mm	19mm	0.8mm	Strip
	CL-74	4.8mm	15.5mm	19mm	0.8mm	Strip
M46B	CL-12	6.2mm	11.0mm	11mm	0.8mm	Strip
	CL-14	6.2mm	12.7mm	11mm	0.8mm	Strip
	CL-16	6.2mm	15.0mm	11mm	0.8mm	Strip
M45B	CL-18	6.2mm	13.3mm	11mm	0.8mm	Strip
	CL-13	4.8mm	10.7mm	11mm	0.8mm	Strip
	CL-15	4.8mm	9.9mm	11mm	0.8mm	Strip
	CL-17	4.8mm	10.0mm	11mm	0.8mm	Strip

88 Series

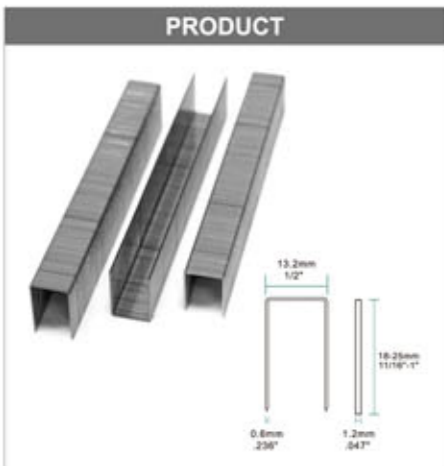

STAPLE SPECIFICATIONS				
MODEL	SIZE	FINISH	BOX / QTY	BOX / CTN
1218J	5/8"(18mm)	Galv	3000	20
1220J	3/4"(20mm)	Galv	3000	20
1222J	8/8"(22mm)	Galv	3000	20

FINISH & WOODWORKING



23 GA HEADLESS PIN

**MP622**  
7/8" Headless Pinner

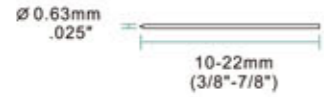

FEATURES	APPLICATIONS
▶ Well-balanced, ergonomically designed	▶ Windows & Door
▶ Powerful for heavy-duty applications	▶ Cabinets
▶ Rear exhaust with embedded silencer	▶ Interior Decoration
▶ Secondary trigger design	
▶ Automatic adjustment magazine	

FASTENER	SIMILAR TOOLS
Type: Glued Strip Headless Pins	
Gauge Size: 23GA	
Wire Dia.: 0.63mm(.024")	
Length: 10-22mm(3/8"-7/8")	
Material: Galvanized, Stainless	

TOOL SPECIFICATIONS			
Weight:	0.82kg/1.81lbs	Capacity:	100pcs
Height:	166mm/6.53"	Operating Pressure:	70-100psi
Length:	230mm/9.05"	Air Inlet:	1/4"NPT
Width:	51mm/2"	Trigger:	Trigger

23 GA HEADLESS PIN

**MP630**  
1 3/16" Headless Pinner

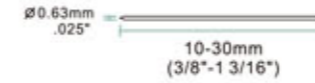

FEATURES	APPLICATIONS
▶ Well-balanced, ergonomically designed	▶ Windows & Door
▶ Powerful for heavy-duty applications	▶ Cabinets
▶ Rear exhaust with embedded silencer	▶ Interior Decoration
▶ Secondary trigger design	
▶ Automatic adjustment magazine	

FASTENER	SIMILAR TOOLS
Type: Glued Strip Headless Pins	▶ GREX P630
Gauge Size: 23GA	▶ Bostitch HP 118K
Wire Dia.: 0.63mm(.024")	
Length: 10-30mm(3/8"-1 3/16")	
Material: Galvanized, Stainless	

TOOL SPECIFICATIONS			
Weight:	0.90kg/1.98lbs	Capacity:	100pcs
Height:	182mm/7.16"	Operating Pressure:	70-100psi
Length:	230mm/9.05"	Air Inlet:	1/4"NPT
Width:	51mm/2"	Trigger:	Trigger

23 GA HEADLESS PIN

**P630C**  
1 3/16" Headless Pinner

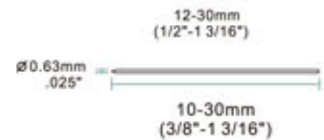

FEATURES	APPLICATIONS
▶ Well-balanced, ergonomically designed	▶ Windows & Door
▶ Powerful for heavy-duty applications	▶ Cabinets
	▶ Interior Decoration

FASTENER	SIMILAR TOOLS
Type: Glued Strip Headless Pins	
Gauge Size: 23GA	
Wire Dia.: 0.63mm(.024")	
Length: 10-30mm(3/8"-1 3/16")	
Material: Galvanized, Stainless	

TOOL SPECIFICATIONS			
Weight:	0.92kg/2.03lbs	Capacity:	150pcs
Height:	178mm/7"	Operating Pressure:	70-100psi
Length:	215mm/8.46"	Air Inlet:	1/4"NPT
Width:	42mm/1.65"	Trigger:	Trigger

23 GA HEADLESS PIN

**MP635**  
1 3/8" Headless Pinner

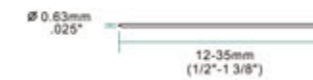

FEATURES	APPLICATIONS
▶ Well-balanced, ergonomically designed	▶ Windows & Door
▶ Powerful for heavy-duty applications	▶ Cabinets
▶ Rear exhaust with embedded silencer	▶ Interior Decoration
▶ Secondary trigger design	
▶ Automatic adjustment magazine	

FASTENER	SIMILAR TOOLS
Type: Glued Strip Headless Pins	▶ MAX NF235A/23-35
Gauge Size: 23GA	▶ SENCO FIP23SXP
Wire Dia.: 0.63mm(.024")	▶ GREX P635
Length: 12-35mm(1/2"-1 3/8")	▶ Cadex V1/23.35
Material: Galvanized, Stainless	

TOOL SPECIFICATIONS			
Weight:	1.1kg/2.43lbs	Capacity:	100pcs
Height:	194mm/7.63"	Operating Pressure:	70-100psi
Length:	230mm/9.05"	Air Inlet:	1/4"NPT
Width:	60mm/2.36"	Trigger:	Trigger

23 GA  
HEADLESS PIN

**MP650B**  
2" Headless / Mini Brad Pinner



FEATURES	APPLICATIONS
▶ Well-balanced, ergonomically designed	▶ Windows & Door
▶ Powerful for heavy-duty applications	▶ Cabinets
▶ Rear exhaust with embedded silencer	▶ Interior Decoration
▶ Secondary trigger design	
▶ Automatic adjustment magazine	

FASTENER		SIMILAR TOOLS	
Type:	Glued Strip Headless Pins	▶ Senco Finish Pro 23LXP	
Gauge Size:	23GA	▶ GREX P650	
Wire Dia.:	0.63mm (.024")	▶ Cadex CPB23.50	
Length:	12-50mm (1/2"-2")		
Material:	Galvanized, Stainless		

TOOL SPECIFICATIONS			
Weight:	1.15kg/2.54lbs	Capacity:	100pcs
Height:	226mm/8.89"	Operating Pressure:	80-100psi
Length:	230mm/9.05"	Air Inlet:	1/4"NPT
Width:	60mm/2.36"	Trigger:	Trigger

Premium  
**21 GA**  
Headless & Mini Brad Pinner  
For Professionals



*Perfect in details*

21 GA  
HEADLESS PIN

**MT850**  
2" Headless / Mini Brad Pinner

FEATURES	APPLICATIONS
▶ Well-balanced, ergonomically designed	▶ Windows & Door
▶ Powerful for heavy-duty applications	▶ Cabinets
▶ Rear exhaust with embedded silencer	▶ Interior Decoration
▶ Secondary trigger design	
▶ Automatic adjustment magazine	

FASTENER		SIMILAR TOOLS	
Type:	Glued Strip Headless Pins	▶ Senco Finish Pro 21LXP	
Gauge Size:	21GA	▶ Omer MG40	
Wire Dia.:	0.84mm (.033")	▶ Cadex CPB21.50	
Length:	12-50mm (1/2"-2")		
Material:	Galvanized, Stainless		

TOOL SPECIFICATIONS			
Weight:	1.3kg/2.87lbs	Capacity:	147pcs
Height:	227mm/8.93"	Operating Pressure:	80-100psi
Length:	256mm/10.07"	Air Inlet:	1/4"NPT
Width:	60mm/2.36"	Trigger:	Trigger

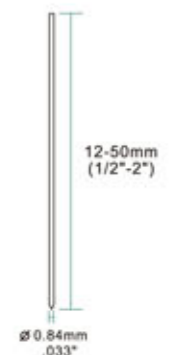

21 GA  
HEADLESS PIN

**MT840**  
1 9/16" Headless / Mini Brad Pinner



FEATURES	APPLICATIONS
▶ Well-balanced, ergonomically designed	▶ Windows & Door
▶ Powerful for heavy-duty applications	▶ Cabinets
▶ Rear exhaust with embedded silencer	▶ Interior Decoration
▶ Secondary trigger design	
▶ Automatic adjustment magazine	

FASTENER		SIMILAR TOOLS	
Type:	Glued Strip Headless Pins	▶ Omer MG40	
Gauge Size:	21GA	▶ Bostitch MB2140	
Wire Dia.:	0.84mm (.033")		
Length:	12-40mm (1/2"-1 9/16")		
Material:	Galvanized, Stainless		

TOOL SPECIFICATIONS			
Weight:	1.19kg/2.62lbs	Capacity:	147pcs
Height:	208mm/8.18"	Operating Pressure:	80-100psi
Length:		Air Inlet:	1/4"NPT
Width:	60mm/2.36"	Trigger:	Trigger

23 GA  
HEADLESS PIN

Headless Pins Series



PINS SPECIFICATIONS				
MODEL	SIZE	FINISH	BOX / QTY	BOX / CTN
608	5/16"(8mm)	Copper Coating / Stainless	10000	48
610	3/8"(10mm)	Copper Coating / Stainless	10000	48
612	1/2"(12mm)	Copper Coating / Stainless	10000	48
615	5/8"(15mm)	Copper Coating / Stainless	10000	48
618	3/4"(18mm)	Copper Coating / Stainless	10000	48
620	13/16"(20mm)	Copper Coating / Stainless	10000	48
622	7/8"(22mm)	Copper Coating / Stainless	10000	48
625	1"(25mm)	Copper Coating / Stainless	10000	48
630	1 3/16"(30mm)	Copper Coating / Stainless	10000	48
635	1 3/8"(35mm)	Copper Coating / Stainless	10000	24/48
640	1 9/16"(40mm)	Copper Coating / Stainless	10000	48
645	1 3/4"(45mm)	Copper Coating / Stainless	10000	48
650	2"(50mm)	Copper Coating / Stainless	10000	48



FURNITURE & UPHOLSTERY



22 GA  
FINE WIRE  
STAPLE

21 GA  
FINE WIRE  
STAPLE

20 GA  
FINE WIRE  
STAPLE

**MT7116 / MT8016 / MT5016**  
Fine Wire Stapler / Standard



FEATURES	
▶	Compact and light weight design
▶	Built in silencer makes soft noise
▶	Rear exhaust keeps oil off fabric and face
▶	Ergonomic handle with rubber comfort grip
▶	Durable driver and bumper for long life

APPLICATIONS	
▶	Upholstery
▶	Furniture
▶	Cabinets
▶	Car Seat
▶	Picture Frames

FASTENER SPECIFICATIONS			
Model:	MT7116	MT8016	MT5016
Type:	22GA Fine Wire Staples	21GA Fine Wire Staples	20GA Fine Wire Staples
Length:	6-16mm(1/4"-5/8")	6-16mm(1/4"-5/8")	6-16mm(1/4"-5/8")
Width:	0.75mm(.029")	0.95mm(.037")	1.27mm(.050")
Thickness:	0.60mm(.023")	0.65mm(.025")	0.53mm(.020")
Crown:	9.0mm(3/8")	12.8mm(1/2")	12.6mm(1/2")
Collation Type:	Glued Strip	Glued Strip	Glued Strip

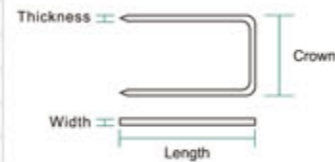

TOOL SPECIFICATIONS			
Model:	MT7116	MT8016	MT5016
Weight:	0.94kg/2.07lbs	0.94kg/2.07lbs	0.94kg/2.07lbs
Height:	105mm/4.13"	105mm/4.13"	105mm/4.13"
Length:	213mm/8.38"	213mm/8.38"	213mm/8.38"
Width:	44mm/1.73"	44mm/1.73"	44mm/1.73"
Capacity:	190pcs	150pcs	114pcs
Operating Pressure:	70-100psi	70-100psi	70-100psi
Air Inlet:	1/4"NPT	1/4"NPT	1/4"NPT
Trigger:	Trigger	Trigger	Trigger

22 GA  
FINE WIRE  
STAPLE

21 GA  
FINE WIRE  
STAPLE

20 GA  
FINE WIRE  
STAPLE

**MT7116S / MT8016S / MT5016S**  
Fine Wire Stapler / Secondary Trigger



FEATURES	
▶	Compact and light weight design
▶	Built in silencer makes soft noise
▶	Rear exhaust keeps oil off fabric and face
▶	Ergonomic handle with rubber comfort grip
▶	Durable driver and bumper for long life

APPLICATIONS	
▶	Upholstery
▶	Furniture
▶	Cabinets
▶	Car Seat
▶	Picture Frames

FASTENER SPECIFICATIONS			
Model:	MT7116S	MT8016S	MT5016S
Type:	22GA Fine Wire Staples	21GA Fine Wire Staples	20GA Fine Wire Staples
Length:	6-16mm(1/4"-5/8")	6-16mm(1/4"-5/8")	6-16mm(1/4"-5/8")
Width:	0.75mm(.029")	0.95mm(.037")	1.27mm(.050")
Thickness:	0.60mm(.023")	0.65mm(.025")	0.53mm(.020")
Crown:	9.0mm(3/8")	12.8mm(1/2")	12.6mm(1/2")
Collation Type:	Glued Strip	Glued Strip	Glued Strip

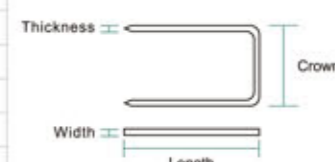

TOOL SPECIFICATIONS			
Model:	MT7116S	MT8016S	MT5016S
Weight:	0.95kg/2.09lbs	0.95kg/2.09lbs	0.95kg/2.09lbs
Height:	105mm/4.13"	105mm/4.13"	105mm/4.13"
Length:	213mm/8.38"	213mm/8.38"	213mm/8.38"
Width:	44mm/1.73"	44mm/1.73"	44mm/1.73"
Capacity:	190pcs	150pcs	114pcs
Operating Pressure:	70-100psi	70-100psi	70-100psi
Air Inlet:	1/4"NPT	1/4"NPT	1/4"NPT
Trigger:	Trigger	Trigger	Trigger

22 GA  
FINE WIRE  
STAPLE

21 GA  
FINE WIRE  
STAPLE

20 GA  
FINE WIRE  
STAPLE

**MT7116LN / MT8016LN / MT5016SLN**  
Fine Wire Stapler / Long Nose



**FEATURES**

- ▶ Compact and light weight design
- ▶ Built in silencer makes soft noise
- ▶ Rear exhaust keeps oil off fabric and face
- ▶ Ergonomic handle with rubber comfort grip
- ▶ Durable driver and bumper for long life

**APPLICATIONS**

- ▶ Upholstery
- ▶ Furniture
- ▶ Cabinets
- ▶ Car Seat
- ▶ Picture Frames

Long nose

**FASTENER SPECIFICATIONS**

Model:	MT7116LN	MT8016LN	MT5016SLN
Type:	22GA Fine Wire Staples	21GA Fine Wire Staples	20GA Fine Wire Staples
Length:	6-16mm(1/4"-5/8")	6-16mm(1/4"-5/8")	6-16mm(1/4"-5/8")
Width:	0.75mm(.029")	0.95mm(.037")	1.27mm(.050")
Thickness:	0.60mm(.023")	0.65mm(.025")	0.53mm(.020")
Crown:	9.0mm(3/8")	12.8mm(1/2")	12.6mm(1/2")
Collation Type:	Glued Strip	Glued Strip	Glued Strip

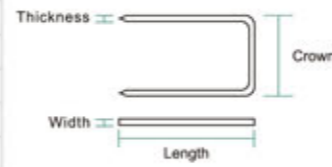

**TOOL SPECIFICATIONS**

Model:	MT7116LN	MT8016LN	MT5016SLN
Weight:	1.03kg/2.27lbs	1.03kg/2.27lbs	1.03kg/2.27lbs
Height:	192mm/7.55"	192mm/7.55"	192mm/7.55"
Length:	221mm/8.70"	221mm/8.70"	221mm/8.70"
Width:	43mm/1.69"	43mm/1.69"	43mm/1.69"
Capacity:	190pcs	150pcs	114pcs
Operating Pressure:	70-100psi	70-100psi	70-100psi
Air Inlet:	1/4"NPT	1/4"NPT	1/4"NPT
Trigger:	Trigger	Trigger	Trigger

21 GA  
FINE WIRE  
STAPLE

20 GA  
FINE WIRE  
STAPLE

**MTP8016 / MTP5016**  
Fine Wire Stapling Plier



**FEATURES**

- ▶ Built in silencer
- ▶ Rear exhaust
- ▶ Rubber comfort grip

**APPLICATIONS**

- ▶ Furniture
- ▶ Cabinets
- ▶ Car Seat
- ▶ Picture Frame
- ▶ Bedding

**FASTENER SPECIFICATIONS**

Model:	MTP8016	MTP5016
Type:	21GA Fine Wire Staples	20GA Fine Wire Staples
Length:	6-16mm(1/4"-5/8")	6-16mm(1/4"-5/8")
Width:	0.95mm(.037")	1.27mm(.050")
Thickness:	0.65mm(.025")	0.53mm(.020")
Crown:	12.8mm(1/2")	12.6mm(1/2")
Collation Type:	Glued Strip	Glued Strip

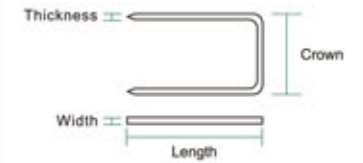

**TOOL SPECIFICATIONS**

Model:	MTP8016	MTP5016
Weight:	1.5kg/3.31lbs	1.5kg/3.31lbs
Height:	230mm/9.05"	230mm/9.05"
Length:	225mm/8.85"	225mm/8.85"
Width:	60mm/2.36"	60mm/2.36"
Capacity:	125pcs	125pcs
Operating Pressure:	70-100psi	70-100psi
Air Inlet:	1/4"NPT	1/4"NPT
Trigger:	Trigger	Trigger

**22 GA** FINE WIRE STAPLE  
**21 GA** FINE WIRE STAPLE  
**7116 / 8016D / 1416**  
Fine Wire Stapler / Rear Trigger



- FEATURES**
- ▶ Compact and light weight design
  - ▶ Built in silencer makes soft noise
  - ▶ Rear exhaust keeps oil off fabric and face
  - ▶ Ergonomic handle with rubber comfort grip
  - ▶ Durable driver and bumper for long life
  - ▶ One hand magazine opening

- APPLICATIONS**
- ▶ Upholstery
  - ▶ Furniture
  - ▶ Cabinets
  - ▶ Car Seat
  - ▶ Picture Frames

FASTENER SPECIFICATIONS			
Model:	7116	8016D	1416
Type:	22GA Fine Wire Staples	21GA Fine Wire Staples	22GA Fine Wire Staples
Length:	6-16mm(1/4"-5/8")	6-16mm(1/4"-5/8")	6-16mm(1/4"-5/8")
Width:	0.75mm(.029")	0.95mm(.037")	0.75mm(.029")
Thickness:	0.60mm(.023")	0.65mm(.025")	0.55mm(.021")
Crown:	9.0mm(3/8")	12.8mm(1/2")	9.93mm(3/8")
Collation Type:	Glued Strip	Glued Strip	Glued Strip

TOOL SPECIFICATIONS			
Model:	7116	8016D	1416
Weight:	0.94kg/2.07lbs	0.94kg/2.07lbs	0.94kg/2.07lbs
Height:	152mm/5.98"	152mm/5.98"	145mm/5.70"
Length:	240mm/9.44"	240mm/9.44"	208mm/8.18"
Width:	40mm/1.57"	40mm/1.57"	50mm/1.96"
Capacity:	190pcs	150pcs	190pcs
Operating Pressure:	70-100psi	70-100psi	70-100psi
Air Inlet:	1/4"NPT	1/4"NPT	1/4"NPT
Trigger:	Trigger	Trigger	Trigger

**22 GA** FINE WIRE STAPLE  
**21 GA** FINE WIRE STAPLE  
**7116C / 8016F**  
Fine Wire Stapler / Rear Trigger



- FEATURES**
- ▶ Compact and light weight design
  - ▶ Built in silencer makes soft noise
  - ▶ Rear exhaust keeps oil off fabric and face
  - ▶ Ergonomic handle with rubber comfort grip
  - ▶ Durable driver and bumper for long life
  - ▶ One hand magazine opening

- APPLICATIONS**
- ▶ Upholstery
  - ▶ Furniture
  - ▶ Cabinets
  - ▶ Car Seat
  - ▶ Picture Frames

FASTENER SPECIFICATIONS		
Model:	7116C	8016F
Type:	22GA Fine Wire Staples	20GA Fine Wire Staples
Length:	6-16mm(1/4"-5/8")	6-16mm(1/4"-5/8")
Width:	0.75mm(.029")	0.95mm(.037")
Thickness:	0.60mm(.023")	0.65mm(.025")
Crown:	9.0mm(3/8")	12.8mm(1/2")
Collation Type:	Glued Strip	Glued Strip

TOOL SPECIFICATIONS		
Model:	7116C	8016F
Weight:	0.93kg/2.05lbs	0.94kg/2.07lbs
Height:	151mm/5.94"	151mm/5.94"
Length:	220mm/8.66"	220mm/8.66"
Width:	39mm/1.53"	39mm/1.53"
Capacity:	179pcs	150pcs
Operating Pressure:	70-100psi	70-100psi
Air Inlet:	1/4"NPT	1/4"NPT
Trigger:	Trigger	Trigger

22 GA  
FINE WIRE  
STAPLE

**7116B / 8016B / 1416B**  
Fine Wire Stapler

21 GA  
FINE WIRE  
STAPLE



**FEATURES**

- ▶ Compact and light weight design
- ▶ Ergonomic handle with rubber comfort grip
- ▶ Durable driver and bumper for long life

**APPLICATIONS**

- ▶ Upholstery
- ▶ Furniture
- ▶ Cabinets
- ▶ Car Seat
- ▶ Picture Frames

20 GA  
FINE WIRE  
STAPLE

**422J / 1022J**  
Fine Wire Stapler



**FEATURES**

- ▶ Compact and light weight design
- ▶ Ergonomic handle with rubber comfort grip
- ▶ Durable driver and bumper for long life

**APPLICATIONS**

- ▶ Upholstery
- ▶ Furniture
- ▶ Cabinets
- ▶ Car Seat
- ▶ Picture Frames

**FASTENER SPECIFICATIONS**

Model:	7116B	8016B	1416B
Type:	22GA Fine Wire Staples	21GA Fine Wire Staples	22GA Fine Wire Staples
Length:	6-16mm(1/4"-5/8")	6-16mm(1/4"-5/8")	6-16mm(1/4"-5/8")
Width:	0.75mm(.029")	0.95mm(.037")	0.75mm(.029")
Thickness:	0.60mm(.023")	0.65mm(.025")	0.55mm(.021")
Crown:	9.0mm(3/8")	12.8mm(1/2")	9.93mm(3/8")
Collation Type:	Glued Strip	Glued Strip	Glued Strip

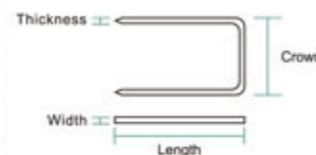

**FASTENER SPECIFICATIONS**

Model:	422J	1022J
Type:	20GA Fine Wire Staples	20GA Fine Wire Staples
Length:	6-25mm(1/4"-1")	10-25mm(3/8"-1")
Width:	1.20mm(.047")	1.20mm(.047")
Thickness:	0.60mm(.023")	0.60mm(.023")
Crown:	5.2mm(1/4")	11.2mm(7/16")
Collation Type:	Glued Strip	Glued Strip

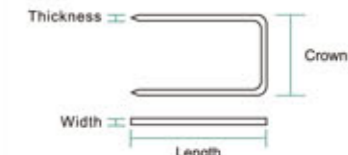

**TOOL SPECIFICATIONS**

Model:	7116B	8016B	1416B
Weight:	0.95kg/2.09lbs	0.95kg/2.09lbs	0.95kg/2.09lbs
Height:	145mm/5.70"	145mm/5.70"	145mm/5.70"
Length:	207mm/8.14"	207mm/8.14"	207mm/8.14"
Width:	50mm/1.96"	50mm/1.96"	50mm/1.96"
Capacity:	190pcs	150pcs	190pcs
Operating Pressure:	70-100psi	70-100psi	70-100psi
Air Inlet:	1/4"NPT	1/4"NPT	1/4"NPT
Trigger:	Trigger	Trigger	Trigger

**TOOL SPECIFICATIONS**

Model:	422J	1022J
Weight:	1.17kg/2.58lbs	1.3kg/2.87lbs
Height:	168mm/6.61"	168mm/6.61"
Length:	240mm/9.44"	240mm/9.44"
Width:	58mm/2.28"	55mm/2.16"
Capacity:	100pcs	100pcs
Operating Pressure:	70-100psi	70-100psi
Air Inlet:	1/4"NPT	1/4"NPT
Trigger:	Trigger	Trigger



20 GA  
FINE WIRE  
STAPLE

**MT425J / MT1025J**

Fine Wire Stapler



**FEATURES**

- ▶ 360° exhaust deflector
- ▶ Rubber comfort grip
- ▶ Powerful
- ▶ Light weight

**APPLICATIONS**

- ▶ Cabinets
- ▶ Furniture
- ▶ Windows & Door

18 GA  
MEDIUM WIRE  
STAPLE

**MT432KLM / MT440KLM**

Medium Wire Stapler



**FEATURES**

- ▶ Built in silencer
- ▶ Light weight
- ▶ Rubber comfort grip
- ▶ Single and rapid firing switchable mechanism
- ▶ Adjustable depth control (MT440KLM)

**APPLICATIONS**

- ▶ Furniture
- ▶ Cabinets
- ▶ Windows & Door

**FASTENER SPECIFICATIONS**

Model:	MT425J	MT1025J
Type:	20GA Fine Wire Staples	20GA Fine Wire Staples
Length:	10-25mm(3/8"-1")	10-25mm(3/8"-1")
Width:	1.20mm(.047")	1.20mm(.047")
Thickness:	0.60mm(.023")	0.60mm(.023")
Crown:	5.2mm(1/4")	11.2mm(7/16")
Collation Type:	Glued Strip	Glued Strip

**FASTENER SPECIFICATIONS**

Model:	MT432KLM	MT440KLM
Type:	18GA Medium Wire Staples	18GA Medium Wire Staples
Length:	16-32mm(5/8"-1 1/4")	16-40mm(5/8"-1 5/8")
Width:	1.27mm(.050")	1.27mm(.050")
Thickness:	1.05mm(.041")	1.05mm(.041")
Crown:	5.85mm(1/4")	5.85mm(1/4")
Collation Type:	Glued Strip	Glued Strip

**TOOL SPECIFICATIONS**

Model:	MT425J	MT1025J
Weight:	1.17kg/2.58lbs	1.17kg/2.58lbs
Height:	168mm/6.61"	168mm/6.61"
Length:	240mm/9.44"	240mm/9.44"
Width:	58mm/2.28"	58mm/2.28"
Capacity:	100pcs	100pcs
Operating Pressure:	70-100psi	70-100psi
Air Inlet:	1/4"NPT	1/4"NPT
Trigger:	Trigger	Trigger

**TOOL SPECIFICATIONS**

Model:	MT432KLM	MT440KLM
Weight:	1.45kg/3.2lbs	1.97kg/4.34lbs
Height:	220mm/8.66"	242mm/9.52"
Length:	300mm/11.81"	300mm/11.81"
Width:	60mm/2.36"	70mm/2.75"
Capacity:	140pcs	140pcs
Operating Pressure:	80-120psi	80-120psi
Air Inlet:	1/4"NPT	1/4"NPT
Trigger:	Contact	Contact

18 GA  
MEDIUM WIRE  
STAPLE

16 GA  
HEAVY WIRE  
STAPLE

440KB / 9240B / 635TR

Medium Wire Stapler



FEATURES	
▶ Powerful	
▶ Rubber comfort grip	
▶ Well-balanced	
▶ Rear exhaust	
▶ Light weight	
▶ Rapid firing	

APPLICATIONS	
▶ Furniture	
▶ Cabinets	
▶ Windows & Door	

FASTENER SPECIFICATIONS			
Model:	440KB	9240B	635TR
Type:	18GA Medium Wire Staples	18GA Medium Wire Staples	16GA Heavy Wire Staples
Length:	16-40mm(5/8"-1 5/8")	25-40mm(1"-1 5/8")	19-35mm(3/4"-1 3/8")
Width:	1.27mm(.050")	1.27mm(.050")	1.4mm(.055")
Thickness:	1.05mm(.041")	1.05mm(.041")	1.6mm(.062")
Crown:	5.85mm(1/4")	8.85mm(5/16")	6mm(1/4")
Collation Type:	Glued Strip	Glued Strip	Glued Strip



TOOL SPECIFICATIONS			
Model:	440KB	9240B	635TR
Weight:	2.1kg/4.63lbs	1.97kg/4.34lbs	1.95kg/4.3lbs
Height:	270mm/10.62"	246mm/9.68"	246mm/9.68"
Length:	298mm/11.73"	310mm/12.20"	310mm/12.20"
Width:	73mm/2.87"	73mm/2.87"	73mm/2.87"
Capacity:	140pcs	100pcs	100pcs
Operating Pressure:	80-120psi	80-120psi	80-120psi
Air Inlet:	1/4"NPT	1/4"NPT	1/4"NPT
Trigger:	Contact	Contact	Contact



Premium  
**16GA & 17GA**  
Heavy Wire Stapler  
For Professionals

Perfect in details

MT-N851-H

7/16" Crown Heavy Wire Stapler

FEATURES	
▶ Light weight	
▶ Well-balanced	
▶ Powerful	
▶ Depth control with a simple adjustable knob	
▶ Single and rapid firing switchable mechanism	
▶ Quick jams release	

APPLICATIONS	
▶ Solid wood furniture	
▶ Wooden packing boxes	
▶ Sofa frame	
▶ Sheathing	
▶ Roof decking	
▶ Subflooring etc	

FASTENER			
Type:	17GA Heavy Wire Staples	16GA Heavy Wire Staples	
Length:	25-50mm(1"-2")	25-51mm(1"-2")	
Width:	1.45mm(.057")	1.6mm(.063")	
Thickness:	1.3mm(.051")	1.4mm(.055")	
Crown:	10.5mm(7/16")	10.8mm(7/16")	
Collation Type:	Glued Strip	Glued Strip	

TOOL SPECIFICATIONS			
Weight:	2.5kg/5.51lbs	Capacity:	140pcs
Height:	288mm/11.33"	Operating Pressure:	80-120psi
Length:	370mm/14.56"	Air Inlet:	1/4"NPT
Width:	93mm/3.66"	Trigger:	Contact

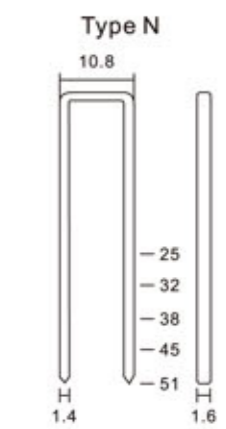
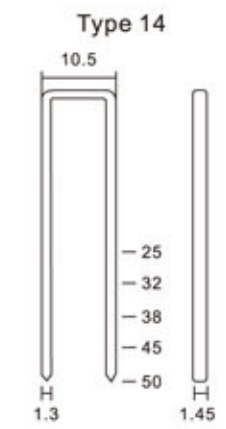

## Premium 16GA & 17GA Heavy Wire Stapler For Professionals



Perfect in details

### MT-N851-L

7/16" Crown Heavy Wire Stapler

FEATURES	APPLICATIONS
<ul style="list-style-type: none"> <li>Well-balanced</li> <li>Light weight</li> <li>Depth control with a simple adjustable knob</li> <li>Quick jams release</li> </ul>	<ul style="list-style-type: none"> <li>Solid wood furniture</li> <li>Wooden packing boxes</li> <li>Sofa frame</li> <li>Sheathing</li> <li>Roof decking</li> <li>Subflooring etc</li> </ul>

FASTENER			
Type:	17GA Heavy Wire Staples	16GA Heavy Wire Staples	
Length:	25-50mm(1"-2")	25-51mm(1"-2")	
Width:	1.45mm(.057")	1.6mm(.063")	
Thickness:	1.3mm(.051")	1.4mm(.055")	
Crown:	10.5mm(7/16")	10.8mm(7/16")	
Collation Type:	Glued Strip	Glued Strip	

TOOL SPECIFICATIONS			
Weight:	2.2kg/4.85lbs	Capacity:	140pcs
Height:	288mm/11.33"	Operating Pressure:	80-120psi
Length:	370mm/14.56"	Air Inlet:	1/4"NPT
Width:	93mm/3.66"	Trigger:	Contact

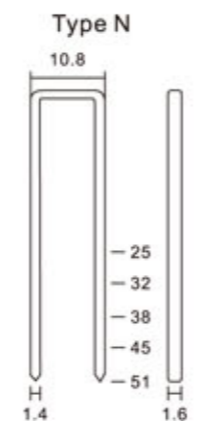
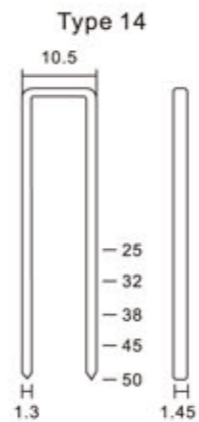

### 16 GA HEAVY WIRE STAPLE

## N851F

7/16" Crown Heavy Wire Stapler



FEATURES	APPLICATIONS
<ul style="list-style-type: none"> <li>Powerful</li> <li>Rubber comfort grip</li> <li>Well-balanced</li> </ul>	<ul style="list-style-type: none"> <li>Solid wood furniture</li> <li>Wooden packing boxes</li> <li>Sofa frame</li> <li>Sheathing</li> <li>Roof decking</li> <li>Subflooring etc</li> </ul>

FASTENER		SIMILAR TOOLS	
Type:	16GA Heavy Wire Staples		
Length:	25-50mm(1"-2")		
Width:	1.6mm(.062")		
Thickness:	1.4mm(.055")		
Crown:	10.8mm(7/16")		
Collation Type:	Glued Strip		

TOOL SPECIFICATIONS			
Weight:	2.8kg/6.17lbs	Capacity:	140pcs
Height:	287mm/11.29"	Operating Pressure:	80-120psi
Length:	340mm/13.38"	Air Inlet:	1/4"NPT
Width:	100mm/3.93"	Trigger:	Contact

### 16 GA HEAVY WIRE STAPLE

## PW2638-L

1" Crown Heavy Wire Stapler

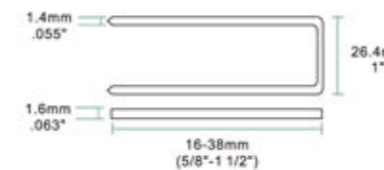

FEATURES	APPLICATIONS
<ul style="list-style-type: none"> <li>Light weight</li> <li>Rapid firing</li> <li>Rubber comfort grip</li> <li>Quick jams release</li> </ul>	<ul style="list-style-type: none"> <li>Windows &amp; Door</li> <li>Corrugated carton to skid</li> <li>For miter joint applications</li> </ul>

FASTENER		SIMILAR TOOLS	
Type:	16GA Heavy Wire Staples		
Length:	16-38mm(5/8"-1 1/2")		
Width:	1.6mm(.062")		
Thickness:	1.4mm(.055")		
Crown:	26.4mm(1")		
Collation Type:	Glued Strip		

TOOL SPECIFICATIONS			
Weight:	2.5kg/5.51lbs	Capacity:	140pcs
Height:	272mm/10.70"	Operating Pressure:	80-120psi
Length:	372mm/14.64"	Air Inlet:	3/8"NPT
Width:	83mm/3.26"	Trigger:	Contact

**22**  
GA  
FINE WIRE  
STAPLE

**71 Series**



**STAPLE SPECIFICATIONS**

MODEL	SIZE	FINISH	BOX / QTY	BOX / CTN
7104	5/32"(4mm)	Galv	10000	20
7106	1/4"(6mm)	Galv	10000	20
7108	5/16"(8mm)	Galv	10000	20
7110	3/8"(10mm)	Galv	10000	20
7112	1/2"(12mm)	Galv	10000	20
7114	9/16"(14mm)	Galv	10000	20
7116	5/8"(16mm)	Galv	10000	20

**21**  
GA  
FINE WIRE  
STAPLE

**80 Series**

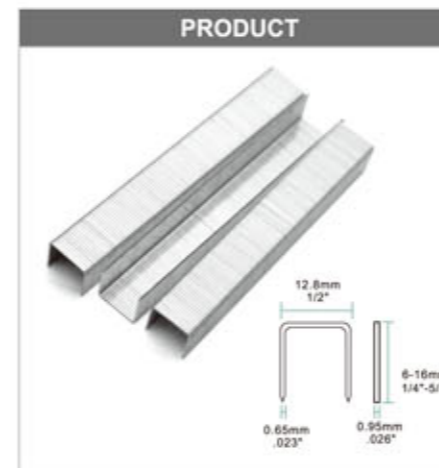

**STAPLE SPECIFICATIONS**

MODEL	SIZE	FINISH	BOX / QTY	BOX / CTN
8006	1/4"(6mm)	Galv	10000	20
8008	5/15"(8mm)	Galv	10000	20
8010	3/8"(10mm)	Galv	10000	10
8012	1/2"(12mm)	Galv	10000	10
8014	9/16"(14mm)	Galv	10000	10
8016	5/8"(16mm)	Galv	10000	10

**20**  
GA  
FINE WIRE  
STAPLE

**50 Series**

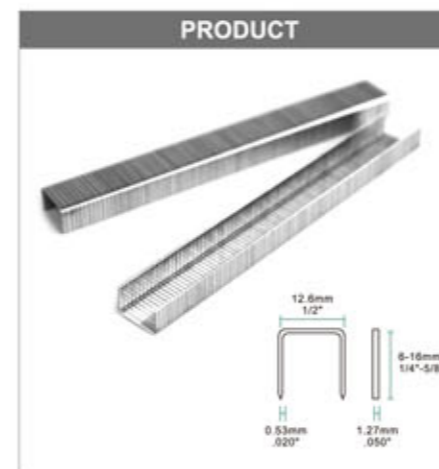

**STAPLE SPECIFICATIONS**

MODEL	SIZE	FINISH	BOX / QTY	BOX / CTN
5006	1/4"(6mm)	Galv	5000	20
5008	5/15"(8mm)	Galv	5000	20
5010	3/8"(10mm)	Galv	5000	20
5012	1/2"(12mm)	Galv	5000	20
5014	9/16"(14mm)	Galv	5000	20
5016	5/8"(16mm)	Galv	5000	20

**22**<sup>GA</sup>  
FINE WIRE  
STAPLE

**10F Series**



STAPLE SPECIFICATIONS				
MODEL	SIZE	FINISH	BOX / QTY	BOX / CTN
1005F	3/16\"(5mm)	Galv	10000	20
1006F	1/4\"(6mm)	Galv	10000	20
1007F	.276\"(7mm)	Galv	10000	20
1008F	5/16\"(8mm)	Galv	10000	20
1010F	3/8\"(10mm)	Galv	10000	20
1012F	1/2\"(12mm)	Galv	10000	20
1014F	9/16\"(14mm)	Galv	10000	20
1016F	5/8\"(16mm)	Galv	10000	20

**20**<sup>GA</sup>  
FINE WIRE  
STAPLE

**10J Series**



STAPLE SPECIFICATIONS				
MODEL	SIZE	FINISH	BOX / QTY	BOX / CTN
J1004	5/32\"(4mm)	Galv	5000	20
J1006	1/4\"(6mm)	Galv	5000	20
J1008	5/16\"(8mm)	Galv	5000	20
J1010	3/8\"(10mm)	Galv	5000	20
J1013	1/2\"(13mm)	Galv	5000	10
J1016	5/16\"(16mm)	Galv	5000	10
J1019	3/4\"(19mm)	Galv	5000	10
J1022	7/8\"(22mm)	Galv	5000	10
J1025	1\"(25mm)	Galv	5000	10

**20**<sup>GA</sup>  
FINE WIRE  
STAPLE

**J4 Series**



STAPLE SPECIFICATIONS				
MODEL	SIZE	FINISH	BOX / QTY	BOX / CTN
J406	1/4\"(6mm)	Galv	5000	20
J408	5/15\"(8mm)	Galv	5000	20
J410	3/8\"(10mm)	Galv	5000	20
J413	1/2\"(13mm)	Galv	5000	20
J416	5/8\"(16mm)	Galv	5000	20
J419	3/4\"(19mm)	Galv	5000	20
J422	7/8\"(22mm)	Galv	5000	20
J425	1\"(25mm)	Galv	5000	20

**18**<sup>GA</sup>  
MEDIUM WIRE  
STAPLE

**90/K Series**

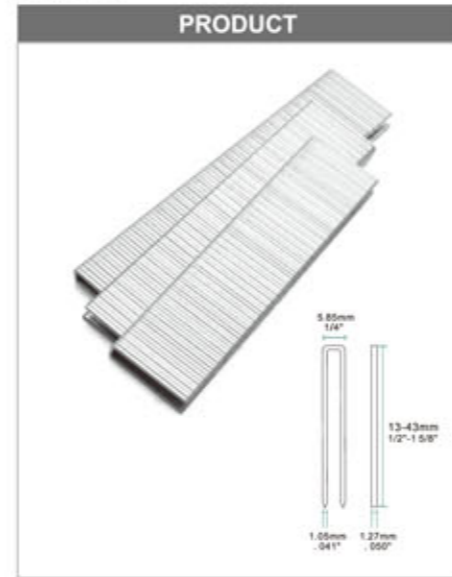

STAPLE SPECIFICATIONS				
MODEL	SIZE	FINISH	BOX / QTY	BOX / CTN
K13	1/2\"(13mm)	Galv	5000	10
K16	5/8\"(16mm)	Galv	5000	10
K19	3/4\"(19mm)	Galv	5000	10
K22	7/8\"(22mm)	Galv	5000	10
K25	1\"(25mm)	Galv	5000	10
K28	1 1/8\"(28mm)	Galv	5000	10
K30	1 3/16\"(30mm)	Galv	5000	10
K32	1 1/4\"(32mm)	Galv	5000	10
K35	1 3/8\"(35mm)	Galv	5000	10
K38	1 1/2\"(38mm)	Galv	5000	10
K40	1 5/8\"(40mm)	Galv	5000	10

**18**<sup>GA</sup>  
MEDIUM WIRE  
STAPLE

**92 Series**



STAPLE SPECIFICATIONS				
MODEL	SIZE	FINISH	BOX / QTY	BOX / CTN
9210	3/8\"(10mm)	Galv	5000	10
9225	1\"(25mm)	Galv	5000	10
9235	1 3/8\"(35mm)	Galv	5000	8
9238	1 1/2\"(38mm)	Galv	5000	8
9240	1 5/8\"(40mm)	Galv	5000	8

**16**<sup>GA</sup>  
HEAVY WIRE  
STAPLE

**N Series**

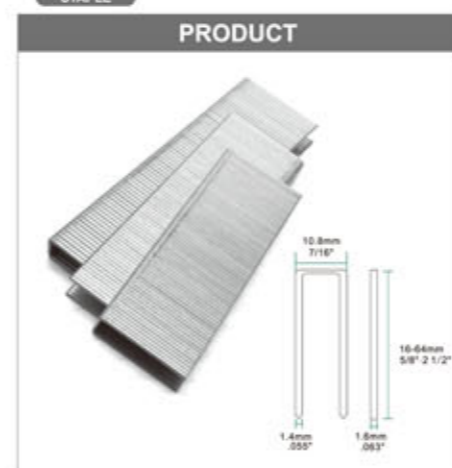

STAPLE SPECIFICATIONS				
MODEL	SIZE	FINISH	BOX / QTY	BOX / CTN
N16	5/8\"(16mm)	Galv	10000	1
N19	3/4\"(19mm)	Galv	10000	1
N22	7/8\"(22mm)	Galv	10000	1
N25	1\"(25mm)	Galv	10000	1
N28	1 1/8\"(28mm)	Galv	10000	1
N32	1 1/4\"(32mm)	Galv	10000	1
N35	1 3/8\"(35mm)	Galv	10000	1
N38	1 1/2\"(38mm)	Galv	10000	1
N40	1 9/16\"(40mm)	Galv	10000	1
N45	1 3/4\"(45mm)	Galv	10000	1
N50	2\"(50mm)	Galv	10000	1

**18<sup>GA</sup>**  
BRAD NAILS  
**MTF32**  
1 1/4" Brad Nailer



FEATURES	APPLICATIONS
▶ 360° exhaust deflector	▶ Windows & Door
▶ Light weight & Well-balanced	▶ Cabinets
▶ Powerful for heavy duty applications	▶ Interior Decoration
▶ Ergonomic handle with rubber comfort grip	

FASTENER	SIMILAR TOOLS
Type: 18GA Brad Nails	
Length: 10-32mm(3/8"-1 1/4")	
Width: 1.25mm(.049")	
Thickness: 1.0mm(.039")	
Collation Type: Glued Strip	

TOOL SPECIFICATIONS			
Weight:	1.25kg/2.76lbs	Capacity:	100pcs
Height:	125mm/4.92"	Operating Pressure:	60-100psi
Length:	240mm/9.44"	Air Inlet:	1/4"NPT
Width:	60mm/2.36"	Trigger:	Trigger

**18<sup>GA</sup>**  
BRAD NAILS  
**F32D**  
1 1/4" Brad Nailer



FEATURES	APPLICATIONS
▶ 360° exhaust deflector	▶ Windows & Door
▶ Light weight & Well-balanced	▶ Cabinets
▶ Powerful for heavy duty applications	▶ Interior Decoration
▶ Quick jams release	

FASTENER	SIMILAR TOOLS
Type: 18GA Brad Nails	
Length: 10-32mm(3/8"-1 1/4")	
Width: 1.25mm(.049")	
Thickness: 1.0mm(.039")	
Collation Type: Glued Strip	

TOOL SPECIFICATIONS			
Weight:	1.22kg/2.69lbs	Capacity:	100pcs
Height:	190mm/7.48"	Operating Pressure:	60-100psi
Length:	247mm/9.72"	Air Inlet:	1/4"NPT
Width:	55mm/2.16"	Trigger:	Contact

**18 GA**  
BRAD NAILS  
**F32**  
1 1/4" Brad Nailer

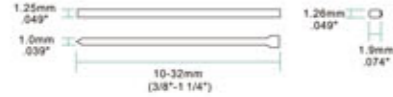

FEATURES	APPLICATIONS
▶ Compact & durable gravity casting body	▶ Windows & Door
▶ Well-balanced	▶ Cabinets
▶ Powerful for heavy duty applications	▶ Interior Decoration
▶ Quick & easy side loading	

FASTENER	SIMILAR TOOLS
<b>Type:</b> 18GA Brad Nails	
<b>Length:</b> 10-32mm(3/8"-1 1/4")	
<b>Width:</b> 1.25mm(.049")	
<b>Thickness:</b> 1.0mm(.039")	
<b>Collation Type:</b> Glued Strip	

TOOL SPECIFICATIONS			
<b>Weight:</b>	1.25kg/2.76lbs	<b>Capacity:</b>	100pcs
<b>Height:</b>	125mm/4.92"	<b>Operating Pressure:</b>	60-100psi
<b>Length:</b>	240mm/9.44"	<b>Air Inlet:</b>	1/4"NPT
<b>Width:</b>	60mm/2.36"	<b>Trigger:</b>	Trigger

**18 GA**  
BRAD NAILS  
**F50C**  
2" Brad Nailer



FEATURES	APPLICATIONS
▶ 360° exhaust deflector	▶ Windows & Door
▶ Light weight & well-balanced	▶ Cabinets
▶ Powerful for heavy duty applications	▶ Interior Decoration
▶ Quick jams release	

FASTENER	SIMILAR TOOLS
<b>Type:</b> 18GA Brad Nails	
<b>Length:</b> 10-50mm(3/8"-2")	
<b>Width:</b> 1.25mm(.049")	
<b>Thickness:</b> 1.0mm(.039")	
<b>Collation Type:</b> Glued Strip	

TOOL SPECIFICATIONS			
<b>Weight:</b>	1.38kg/3.04lbs	<b>Capacity:</b>	100pcs
<b>Height:</b>	238mm/9.37"	<b>Operating Pressure:</b>	57-100psi
<b>Length:</b>	250mm/9.84"	<b>Air Inlet:</b>	1/4"NPT
<b>Width:</b>	57mm/2.24"	<b>Trigger:</b>	Contact

**18 GA**  
BRAD NAILS  
**F50G**  
2" Brad Nailer



FEATURES	APPLICATIONS
▶ Compact & durable gravity casting body	▶ Windows & Door
▶ Well-balanced	▶ Cabinets
▶ Powerful for heavy duty applications	▶ Interior Decoration
▶ Quick & easy side loading	

FASTENER	SIMILAR TOOLS
<b>Type:</b> 18GA Brad Nails	
<b>Length:</b> 10-50mm(3/8"-2")	
<b>Width:</b> 1.25mm(.049")	
<b>Thickness:</b> 1.0mm(.039")	
<b>Collation Type:</b> Glued Strip	

TOOL SPECIFICATIONS			
<b>Weight:</b>	1.38kg/3.04lbs	<b>Capacity:</b>	100pcs
<b>Height:</b>	230mm/9.05"	<b>Operating Pressure:</b>	60-100psi
<b>Length:</b>	240mm/9.44"	<b>Air Inlet:</b>	1/4"NPT
<b>Width:</b>	65mm/2.55"	<b>Trigger:</b>	Contact

**16 GA**  
BRAD NAILS  
**T64A**  
2 1/2" Brad Nailer



FEATURES	APPLICATIONS
▶ 360° exhaust deflector	▶ Windows & Door
▶ Light weight & Well-balanced	▶ Cabinets
▶ Powerful for heavy duty applications	▶ Interior Decoration
▶ Quick jams release	

FASTENER	SIMILAR TOOLS
<b>Type:</b> 16GA Brad Nails	▶ MAX NF565/16
<b>Length:</b> 32-64mm(1 1/4"-2 1/2")	▶ Bostitch FN1664K
<b>Width:</b> 1.6mm(.063")	▶ SENCO FinishPro 32
<b>Thickness:</b> 1.4mm(.055")	
<b>Collation Type:</b> Glued Strip	

TOOL SPECIFICATIONS			
<b>Weight:</b>	1.75kg/3.86lbs	<b>Capacity:</b>	100pcs
<b>Height:</b>	282mm/11.10"	<b>Operating Pressure:</b>	70-100psi
<b>Length:</b>	298mm/11.73"	<b>Air Inlet:</b>	1/4"NPT
<b>Width:</b>	73mm/2.87"	<b>Trigger:</b>	Contact

**16 GA**  
BRAD NAILS  
**T50SA**  
2" Brad Nailer



**FEATURES**

- ▶ Compact & durable gravity casting body
- ▶ Well-balanced
- ▶ Powerful for heavy duty applications
- ▶ Quick and easy side loading

**APPLICATIONS**

- ▶ Windows & Door
- ▶ Cabinets
- ▶ Interior Decoration

**FASTENER**

Type:	16GA Brad Nails
Length:	15-50mm(3/8"-2")
Width:	1.6mm(.063")
Thickness:	1.4mm(.055")
Collation Type:	Glued Strip

**SIMILAR TOOLS**

**TOOL SPECIFICATIONS**

Weight:	1.86kg/4.10lbs	Capacity:	100pcs
Height:	255mm/10.03"	Operating Pressure:	70-100psi
Length:	294mm/11.57"	Air Inlet:	1/4"NPT
Width:	77mm/3.03"	Trigger:	Contact

**16 GA**  
BRAD NAILS  
**FST50**  
2" Brad Nailer



**FEATURES**

- ▶ Compact & durable gravity casting body
- ▶ Well-balanced
- ▶ Powerful for heavy duty applications
- ▶ Quick & easy side loading

**APPLICATIONS**

- ▶ Windows & Door
- ▶ Cabinets
- ▶ Interior Decoration

**FASTENER**

Type:	16GA Brad Nails
Length:	15-50mm(3/8"-2")
Width:	1.6mm(.063")
Thickness:	1.4mm(.055")
Collation Type:	Glued Strip

**SIMILAR TOOLS**

**TOOL SPECIFICATIONS**

Weight:	1.59kg/3.51lbs	Capacity:	100pcs
Height:	255mm/10.03"	Operating Pressure:	70-100psi
Length:	275mm/10.82"	Air Inlet:	1/4"NPT
Width:	62mm/2.44"	Trigger:	Contact

**16 GA**  
BRAD NAILS  
**T50MA**  
2" Brad Nailer



**FEATURES**

- ▶ Compact & durable gravity casting body
- ▶ Well-balanced
- ▶ Powerful for heavy duty applications
- ▶ Quick & easy side loading

**APPLICATIONS**

- ▶ Windows & Door
- ▶ Cabinets
- ▶ Interior Decoration

**FASTENER**

Type:	16GA Brad Nails
Length:	15-50mm(3/8"-2")
Width:	1.6mm(.063")
Thickness:	1.4mm(.055")
Collation Type:	Glued Strip

**SIMILAR TOOLS**

**TOOL SPECIFICATIONS**

Weight:	2.44kg/5.38lbs	Capacity:	100pcs
Height:	257mm/10.11"	Operating Pressure:	70-100psi
Length:	312mm/12.28"	Air Inlet:	1/4"NPT
Width:	78mm/3.07"	Trigger:	Contact

**14 GA**  
CONCRETE NAILS  
**ST64**  
Concrete T Nailer



**FEATURES**

- ▶ Well-balanced
- ▶ Powerful

**APPLICATIONS**

- ▶ Windows & Door
- ▶ Cabinets
- ▶ Interior Decoration

**FASTENER**

Type:	14GA Brad Nail
Length:	18-64mm(3/4"-2 1/2")
Shank Dia.:	2.2mm(.089")
Head Dia.:	6.7mm(1/4")

**SIMILAR TOOLS**

**TOOL SPECIFICATIONS**

Weight:	3.0kg/6.61lbs	Capacity:	50pcs
Height:	267mm/10.51"	Operating Pressure:	70-100psi
Length:	318mm/12.51"	Air Inlet:	1/4"NPT
Width:	95mm/3.74"	Trigger:	Contact





Concrete And Steel Series

CS3025

1" Concrete and Steel Nailer

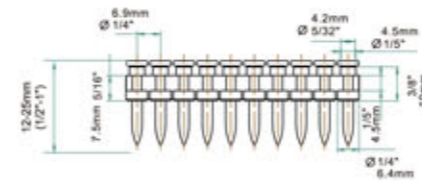

FEATURES
› Works with standard compressed air
› Powerful for heavy duty applications
› Rubber comfort grip
› Durable driver and bumper for long life

APPLICATIONS
› Wood to steel / concrete
› Drywall track to steel / concrete
› Concrete furring

FASTENER
Type: Plastic Collected Concrete Nails
Length: 12-25mm(1/2"-1")
Shank Dia.: 2.6&2.9mm(.104"&.114")
Head Dia.: 6.4mm(.252")
Collation Type: Plastic Collected

SIMILAR TOOLS

TOOL SPECIFICATIONS			
Weight:	2.78kg/6.13lbs	Capacity:	20pcs
Height:	317mm/12.48"	Operating Pressure:	70-100psi
Length:	342mm/13.46"	Air Inlet:	1/4"NPT
Width:	104mm/4.09"	Trigger:	Contact

MTCS3040L

1 1/2" Concrete and Steel Nailer

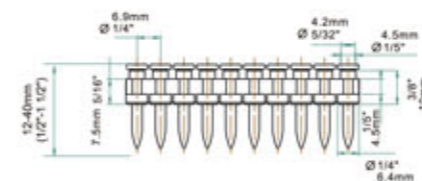

FEATURES
› Works with standard compressed air
› Powerful for heavy duty applications
› Rubber comfort grip
› Durable driver and bumper for long life

APPLICATIONS
› Wood to steel / concrete
› Drywall track to steel / concrete
› Concrete furring

FASTENER
Type: Plastic Collected Concrete Nails
Length: 12-40mm(1/2"-1 1/2")
Shank Dia.: 2.6&2.9mm(.104"&.114")
Head Dia.: 6.4mm(.252")
Collation Type: Plastic Collected

SIMILAR TOOLS

TOOL SPECIFICATIONS			
Weight:	2.9kg/6.39lbs	Capacity:	40pcs
Height:	337mm/13.26"	Operating Pressure:	70-100psi
Length:	342mm/13.46"	Air Inlet:	1/4"NPT
Width:	104mm/4.09"	Trigger:	Contact



**MTCS3040**

1 1/2" Concrete and Steel Nailer



**EXTRA POWER**

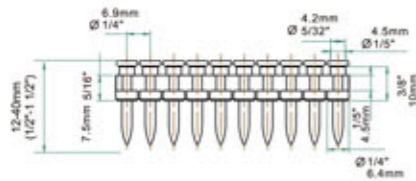

FEATURES	APPLICATIONS
▶ Works with standard compressed air	▶ Wood to steel / concrete
▶ Powerful for heavy duty applications	▶ Drywall track to steel / concrete
▶ Rubber comfort grip	▶ Concrete furring
▶ Durable driver and bumper for long life	

FASTENER	SIMILAR TOOLS
Type: Concrete Nail	
Length: 12-40mm(1/2"-1 1/2")	
Shank Dia.: 2.6&2.9mm(.104"&.114")	
Head Dia.: 6.4mm(.252")	
Collation Type: Plastic Collected	

TOOL SPECIFICATIONS			
Weight:	3.42kg/7.54lbs	Capacity:	40pcs
Height:	360mm/14.17"	Operating Pressure:	70-100psi
Length:	480mm/18.89"	Air Inlet:	1/4"NPT
Width:	120mm/4.72"	Trigger:	Contact

**MT-G38**

1 1/2" Gas Concrete and Steel Nailer



**GAS POWER**

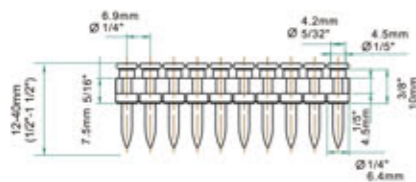

FEATURES	APPLICATIONS
▶ Well-balance, powerful	▶ Wood to steel / concrete
▶ High efficiency, rapid nailing performance	▶ Drywall track to steel / concrete
▶ Easy to disassemble for clean and maintenance	▶ Concrete furring
▶ Compact design, long life span	

FASTENER	SIMILAR TOOLS
Type: Plastic Collected Concrete Nails	
Length: 12-40mm(1/2"-1 1/2")	
Shank Dia.: 2.6&2.9mm(.104"&.114")	
Head Dia.: 6.4mm(.252")	
Collation Type: Plastic Collected	

TOOL SPECIFICATIONS			
Weight:	3.65kg/8.05lbs	Capacity:	30pcs
Height:	400mm/15.74"	Operating Pressure:	/
Length:	350mm/13.77"	Air Inlet:	/
Width:	108mm/4.25"	Trigger:	Contact

PICTURE FRAME & ARTCRAFT



**P515**

Pneumatic Flex Point Tacker

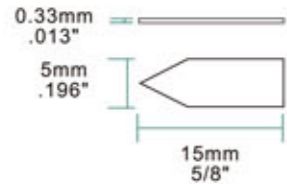

FEATURES		APPLICATIONS	
<ul style="list-style-type: none"> <li>▶ Light weight &amp; well-balanced</li> <li>▶ Rubber comfort grip</li> <li>▶ Ideal for high volume production</li> <li>▶ Quick &amp; easy bottom loading</li> </ul>		▶ Picture Frame	
FASTENER		SIMILAR TOOLS	
Type:	Flex Point Pins	▶ Omer 53-53.4	
Length:	15mm(5/8")		
Thickness:	0.33mm(.013")		
Width:	5mm(.196")		

TOOL SPECIFICATIONS			
Weight:	0.94kg/2.07lbs	Capacity:	200pcs
Height:	162mm/6.37"	Operating Pressure:	60-100psi
Length:	195mm/7.67"	Air Inlet:	1/4"NPT
Width:	43mm/1.69"	Trigger:	Trigger

18<sup>GA</sup>  
BRAD NAILS

**HF18**

Manual Hard Points Tacker

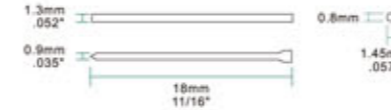

FEATURES		APPLICATIONS	
<ul style="list-style-type: none"> <li>▶ Light weight &amp; Well-balanced</li> <li>▶ Depth adjustment</li> <li>▶ Quick &amp; easy front loading</li> <li>▶ Air free, convenient to use</li> </ul>		▶ Picture Frame	
FASTENER		SIMILAR TOOLS	
Type:	Hard Point Brads	▶ SALCO F-18	
Length:	18mm(11/16")		
Width:	1.3mm(.052")		
Thickness:	0.9mm(.035")		
Collation Type:	Glued Strip		

TOOL SPECIFICATIONS			
Weight:	0.65kg/1.43lbs	Capacity:	100pcs
Height:	127mm/5"	Operating Pressure:	/
Length:	190mm/7.48"	Air Inlet:	/
Width:	31mm/1.22"	Trigger:	Manual

**HM515**

Manual Flex Point Tacker

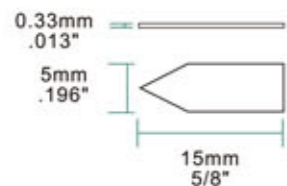

FEATURES		APPLICATIONS	
<ul style="list-style-type: none"> <li>▶ Light weight &amp; well-balanced</li> <li>▶ Depth adjustment</li> <li>▶ Quick &amp; easy front loading</li> <li>▶ Air free, convenient to use</li> </ul>		▶ Picture Frame	
FASTENER		SIMILAR TOOLS	
Type:	Flex Point Pins	▶ Omer 53-53.4	
Length:	15mm(5/8")		
Thickness:	0.33mm(.013")		
Width:	5mm(.196")		

TOOL SPECIFICATIONS			
Weight:	0.62kg/1.37lbs	Capacity:	100pcs
Height:	124mm/4.88"	Operating Pressure:	/
Length:	203mm/7.99"	Air Inlet:	/
Width:	40mm/1.57"	Trigger:	Manual

**V1015B**

V-Nailer

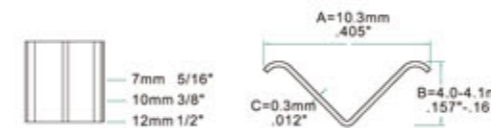

FEATURES		APPLICATIONS	
<ul style="list-style-type: none"> <li>▶ Light weight &amp; Well-balanced</li> <li>▶ Rubber comfort grip</li> <li>▶ Ideal for miter joint applications</li> </ul>		▶ Picture Frame ▶ Windows Door	
FASTENER		SIMILAR TOOLS	
Type:	V-Nails	▶ Omer VNII.15	
Length:	7-112mm(5/16"-1/2")		
Thickness:	0.3mm(.012")		
Height:	4.0-4.1mm(.157"-.161")		
Width:	10.3mm(.405")		
Collation type:	Glued Strip		

TOOL SPECIFICATIONS			
Weight:	1.49kg/3.28lbs	Capacity:	200pcs
Height:	208mm/8.18"	Operating Pressure:	60-100
Length:	270mm/10.62"	Air Inlet:	1/4"NPT
Width:	65mm/2.55"	Trigger:	Trigger

**ZN1400**

Deco Nailer



FEATURES	APPLICATIONS
▶ Light weight	▶ Furniture
▶ Rubber comfort grip	▶ Picture Frame
▶ Magnetic nosepiece	▶ Shoes

TOOL SPECIFICATIONS			
Weight:	0.64kg/1.41lbs	Capacity:	1pcs
Height:	174mm/6.85"	Operating Pressure:	60-100psi
Length:	208mm/8.18"	Air Inlet:	1/4"NPT
Width:	42mm/1.65"	Trigger:	Trigger

MODEL	ZN0630	ZN0750	ZN0860	MODEL	ZN1820	ZN2030	ZN2230
D(mm)	6.3	7.5	8.6	D(mm)	18.2	20.3	22.3
MODEL	ZN0960	ZN1080	ZN1170	MODEL	ZN2530	ZN2830	ZN3030
D(mm)	9.6	10.8	11.7	D(mm)	25.3	28.3	30.0
MODEL	ZN1230	ZN1400	ZN1620				
D(mm)	12.3	14.0	16.2				

Step1 Put the studs on the plate



Step2 Put the nose on the studs



Step3 Actuate the trigger to shoot



**ZN-12**

Automatic Feeding Deco Nailer



FEATURES	APPLICATIONS
▶ Speed control feeding	▶ Furniture
▶ Light weight & well-balanced	▶ Picture Frame
▶ Rapid & easy-loading	▶ Shoes
▶ Ideal for high-volume production	

FASTENER	SIMILAR TOOLS
Type: Deco Nail	
Length: 6-16mm(1/4"-5/8")	
Head Dia. 8.5-10.5mm(.033"-.041")	
Head Height: 3.3-4.0mm(.012"-.015")	
Collation Type: /	

TOOL SPECIFICATIONS			
Weight:	1.09kg/2.40lbs	Capacity:	50pcs
Height:	195mm/7.67"	Operating Pressure:	60-100
Length:	245mm/9.64"	Air Inlet:	1/4"NPT
Width:	95mm/3.74"	Trigger:	Trigger

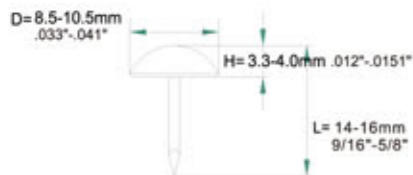

CARTON CLOSING



16 GA  
CARTON  
STAPLE

**HB3515**  
Manual Carton Stapler



FEATURES	APPLICATIONS
<ul style="list-style-type: none"> <li>Adjustable depth control</li> <li>Light weight &amp; well-balanced</li> <li>Air free, convenient to use</li> </ul>	<ul style="list-style-type: none"> <li>Carton Box Closing</li> </ul>

FASTENER	SIMILAR TOOLS
<b>Type:</b> Carton Staples <b>Length:</b> 15mm(5/8") <b>Width:</b> 2.3mm(.09") <b>Thickness:</b> 0.9mm(.035") <b>Crown:</b> 34.7mm(1 3/8") <b>Collation Type:</b> Glued Strip	

TOOL SPECIFICATIONS			
<b>Weight:</b>	2.66kg/5.86lbs	<b>Capacity:</b>	100pcs
<b>Height:</b>	267mm/10.51"	<b>Operating Pressure:</b>	/
<b>Length:</b>	360mm/14.17"	<b>Air Inlet:</b>	/
<b>Width:</b>	105mm/4.13"	<b>Trigger:</b>	Manual

16 GA  
CARTON  
STAPLE

**ADCS-19**  
Pneumatic Carton Stapler

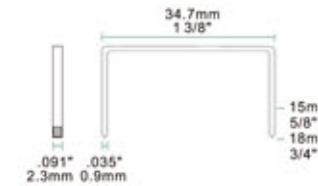
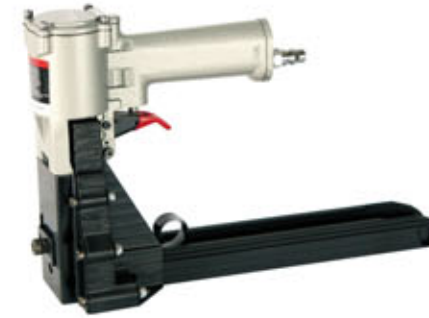

FEATURES	APPLICATIONS
<ul style="list-style-type: none"> <li>Built in silencer for low noise</li> <li>Light weight &amp; well-balanced</li> <li>Ideal for heavy-volume production</li> </ul>	<ul style="list-style-type: none"> <li>Carton Box Closing</li> </ul>

FASTENER	SIMILAR TOOLS
<b>Type:</b> Carton Staples <b>Length:</b> 15-18mm(5/8"-3/4") <b>Crown:</b> 34.7mm(1 3/8") <b>Collation Type:</b> Glued Strip	<ul style="list-style-type: none"> <li>BeAAT A18 AIR</li> <li>Bostitch DS3519</li> <li>OMER 35.18</li> </ul>

TOOL SPECIFICATIONS			
<b>Weight:</b>	2.13kg/4.70lbs	<b>Capacity:</b>	100pcs
<b>Height:</b>	220mm/8.66"	<b>Operating Pressure:</b>	70-100psi
<b>Length:</b>	342mm/13.46"	<b>Air Inlet:</b>	1/4"NPT
<b>Width:</b>	115mm/4.52"	<b>Trigger:</b>	Trigger

16 GA  
CARTON  
STAPLE

**HB3518**  
Manual Carton Stapler

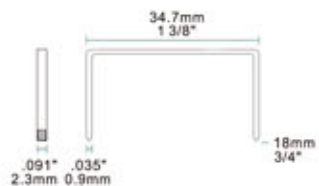

FEATURES	APPLICATIONS
<ul style="list-style-type: none"> <li>Forming control</li> <li>Depth control</li> <li>Light weight</li> </ul>	<ul style="list-style-type: none"> <li>Carton Box Closing</li> </ul>

FASTENER	SIMILAR TOOLS
<b>Type:</b> Carton Staples <b>Length:</b> 18mm(3/4") <b>Width:</b> 2.3mm(.09") <b>Thickness:</b> 0.9mm(.035") <b>Crown:</b> 34.7mm(1 3/8") <b>Collation Type:</b> Glued Strip	<ul style="list-style-type: none"> <li>BeA MTA18</li> <li>Bostitch MS3519</li> <li>OMER 35.18M</li> </ul>

TOOL SPECIFICATIONS			
<b>Weight:</b>	2.66kg/5.86lbs	<b>Capacity:</b>	100pcs
<b>Height:</b>	267mm/10.51"	<b>Operating Pressure:</b>	/
<b>Length:</b>	360mm/14.17"	<b>Air Inlet:</b>	/
<b>Width:</b>	105mm/4.13"	<b>Trigger:</b>	Manual

16 GA  
CARTON  
STAPLE

**ADCS-22**  
Pneumatic Carton Stapler

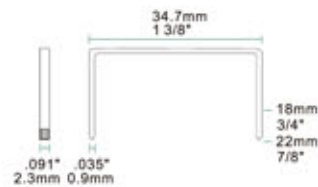

FEATURES	APPLICATIONS
<ul style="list-style-type: none"> <li>Built in silencer for low noise</li> <li>Light weight &amp; well-balanced</li> <li>Ideal for heavy-volume production</li> </ul>	<ul style="list-style-type: none"> <li>Carton Box Closing</li> </ul>

FASTENER	SIMILAR TOOLS
<b>Type:</b> Carton Staples <b>Length:</b> 18-22mm(3/4"-7/8") <b>Crown:</b> 34.7mm(1 3/8") <b>Collation Type:</b> Glued Strip	<ul style="list-style-type: none"> <li>BeAAT A22 AIR</li> <li>Bostitch DS3522</li> <li>OMER 35.22</li> </ul>

TOOL SPECIFICATIONS			
<b>Weight:</b>	2.15kg/4.74lbs	<b>Capacity:</b>	100pcs
<b>Height:</b>	220mm/8.66"	<b>Operating Pressure:</b>	70-100psi
<b>Length:</b>	342mm/13.46"	<b>Air Inlet:</b>	1/4"NPT
<b>Width:</b>	115mm/4.52"	<b>Trigger:</b>	Trigger

**RATA-19**

Pneumatic Roll Carton Stapler



FEATURES		APPLICATIONS	
<ul style="list-style-type: none"> <li>▶ Built in silencer for low noise</li> <li>▶ Light weight &amp; well-balanced</li> <li>▶ Quick jams release</li> <li>▶ Ideal for heavy-volume production</li> </ul>		<ul style="list-style-type: none"> <li>▶ Carton Box Closing</li> </ul>	
FASTENER		SIMILAR TOOLS	
Type:	Carton Staple	▶ Bostitch RAB-19	
Length:	15&18mm(5/8"&3/4")	▶ Omer D.18 ROLL	
Width:	1.9mm(.075")		
Thickness:	0.95mm(.037")		
Collation Type:	Glue		
TOOL SPECIFICATIONS			
Weight:	2.38kg/5.25lbs	Capacity:	1000pcs
Height:	230mm/9.05"	Operating Pressure:	70-100psi
Length:	233mm/9.17"	Air Inlet:	1/4"NPT
Width:	115mm/4.52"	Trigger:	Trigger

**RAIA-19**

Pneumatic Roll Carton Stapler

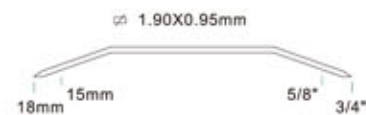

FEATURES		APPLICATIONS	
<ul style="list-style-type: none"> <li>▶ Built in silencer for low noise</li> <li>▶ Light weight &amp; well-balanced</li> <li>▶ Quick jams release</li> <li>▶ Ideal for heavy-volume production</li> </ul>		<ul style="list-style-type: none"> <li>▶ Carton Box Closing</li> </ul>	
FASTENER		SIMILAR TOOLS	
Type:	Carton Staple	▶ BeA CT IC 1823 COIL	
Length:	15&18mm(5/8"&3/4")	▶ Bostitch RAB-19	
Width:	1.9mm(.075")	▶ Omer C.18 ROLL	
Thickness:	0.95mm(.037")		
Collation Type:	Glue		
TOOL SPECIFICATIONS			
Weight:	2.38kg/5.25lbs	Capacity:	1000pcs
Height:	230mm/9.05"	Operating Pressure:	70-100psi
Length:	233mm/9.17"	Air Inlet:	1/4"NPT
Width:	115mm/4.52"	Trigger:	Trigger

SPECIAL



15.5GA  
FLOORING  
STAPLE

## MFS50

Pneumatic Mallet Actuated  
Flooring Stapler

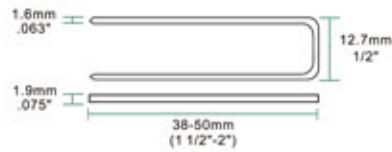

FEATURES	APPLICATIONS
<ul style="list-style-type: none"> <li>▶ Mallet actuated</li> <li>▶ Powerful, well-balanced</li> <li>▶ Ergonomic handle reduces user fatigue</li> </ul>	<ul style="list-style-type: none"> <li>▶ Flooring</li> </ul>

FASTENER	SIMILAR TOOLS
<b>Type:</b> Flooring Staple <b>Length:</b> 38-50mm(1 1/2"-2") <b>Width:</b> 1.9mm(.075") <b>Thickness:</b> 1.6mm(.063") <b>Crown:</b> 12.7mm(1/2") <b>Gauge Size:</b> 15.5GA	<ul style="list-style-type: none"> <li>▶ Bostitch M11IFS</li> <li>▶ SENCO SHFS200</li> <li>▶ Grip-Rite GR200FS</li> </ul>

TOOL SPECIFICATIONS			
<b>Weight:</b>	5.1kg/11.24lbs	<b>Capacity:</b>	90pcs
<b>Height:</b>	564mm/22.20"	<b>Operating Pressure:</b>	70-100
<b>Length:</b>	400mm/15.74"	<b>Air Inlet:</b>	1/4"NPT
<b>Width:</b>	197mm/7.75"	<b>Trigger:</b>	Mallet Actuated

## TH-1213F

Hammer Tacker

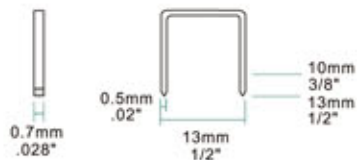

FEATURES	APPLICATIONS
<ul style="list-style-type: none"> <li>▶ Light weight</li> <li>▶ Well-balanced</li> </ul>	<ul style="list-style-type: none"> <li>▶ Packaging</li> </ul>

FASTENER	SIMILAR TOOLS
<b>Type:</b> Fine Wire Staple <b>Length:</b> 10-13mm(3/8"-1/2") <b>Width:</b> 0.7mm(.028") <b>Thickness:</b> 0.5mm(.02") <b>Crown:</b> 11.1mm(7/16") <b>Collation Type:</b> Glued Strip	<ul style="list-style-type: none"> <li>▶ MAX TH-S2</li> </ul>

TOOL SPECIFICATIONS			
<b>Weight:</b>	0.66kg/1.46lbs	<b>Capacity:</b>	144pcs
<b>Height:</b>	71mm/2.79"	<b>Operating Pressure:</b>	/
<b>Length:</b>	315mm/12.40"	<b>Air Inlet:</b>	/
<b>Width:</b>	25mm/0.98"	<b>Trigger:</b>	Manual

### Cylinder Set



### Cylinder Cap



### Bumper



### Active Valve



### Magazine



### Driver Set



### O-ring



### Muzzle



### Lubricant



**meite** special lubricant  
Proper Lubrication is necessary for this pneumatic tool.  
Lube oil through the air inlets before and after for each time use if not using an oiler.  
Proper lubrication can increase the usage length of your tool also prevents rust from forming  
Use MEITE lube oil for best performance.

### Safety Glass



**meite** Safety Glass  
Always wear safety glasses in the work area.