



**YT-81351**



## Inverter DC MMA Arc Welding Machine

**IMPORTANT: Read this Owner's Manual Completely** before attempting to use this equipment. Save this manual and keep it handy for quick reference. Pay particular attention to the safety instructions we have provided for your protection. Contact your distributor if you do not fully understand this manual.



# CONTENT

<b>§1 SAFETY</b> .....	<b>1</b>
§1.1 Signal Explanation.....	1
§1.2 Arc Welding Damage.....	1
§1.3 The knowledge of Electric and Magnetic Fields.....	4
<b>§2 Summary</b> .....	<b>5</b>
§2.1 Brief Introduction.....	5
§2.2 Working Principle.....	5
§2.3 Volt-Ampere Characteristic.....	6
<b>§3 Installation &amp; Adjustment</b> .....	<b>7</b>
§3.1 Parameters.....	7
§3.2 Duty cycle & Over heat.....	7
§3.3 Welding polarity connection way.....	8
§3.3.1 MMA.....	8
<b>§4 Operation control and connectors</b> .....	<b>9</b>
§4.1 Layout for front & rear panel.....	9
§4.2 parameters adjustment.....	10
§4.3 Welding operation.....	10
§4.3.1 Striking arc way.....	10
§4.4.2 Manipulation of electrode.....	11
§4.4 Welding parameters.....	11
§4.4.1 Joint form in MMA.....	11
§4.4.2 Electrode selection.....	11
§4.5 Arc Welding Defect and Prevent Method.....	12
§4.6 Operation Environment.....	13
§4.7 Operation Notices.....	14
<b>§5 Maintenance &amp; Troubleshooting</b> .....	<b>15</b>
§5.1 Maintenance.....	15
§5.2 Troubleshooting.....	16
§5.3 Electrical principle drawing.....	19

# § 1 SAFETY

## §1.1 Signal Explanation



• The above signals mean warning! Notice! Running parts and getting an electric shock or thermal parts will take damage for your body or others. The corresponding notices are as follows. It is quite a safe operation after taking several necessary protection measures.

## §1.2 Arc Welding Damage

- The following signals and word explanations are to some damages for your body or others happening on the welding operation. While seeing these, please remind of yourself or others to be dangerous.
- Only ones who are trained professionally can install, debug, operate, maintain and repair the equipment.
- During the operation, non-concerned people should be lift, especially for children.
- After shut off the machine power, please maintain and examine the equipment according to §5 because of the DC voltage existing in the electrolytic capacitors.

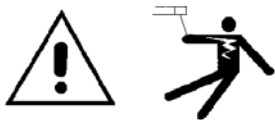

### **ELECTRIC SHOCK CAN KILL.**

- Never touch electrical parts.
- Wear dry, hole-free gloves and clothes to insulate yourself.
- Insulate yourself from work and ground using dry insulation. Make certain the insulation is large enough to cover your full area of physical contact with work and ground.
- Take carefully when using the equipment in small place, falling-off and wet circumstance.
- Never close the machine power before installation and adjustment.
- Ensure to install the equipment correctly and ground the work or metal to be welded to a good electrical (earth) ground according to the operation manual.
- The electrode and work (or ground) circuits are electrically “hot” when the welder is on. Do not touch these “hot” parts with your bare skin or wet clothing. Wear dry, hole-free gloves to insulate hands.

- In semiautomatic or automatic wire welding, the electrode, electrode reel, welding head, nozzle or semiautomatic welding gun are also electrically “hot”.
- Always be sure the work cable makes a good electrical connection with the metal being welded. The connection should be as close as possible to the area being welded.
- Maintain the electrode holder, work clamp, welding cable and welding machine in good, safe operating condition. Replace damaged insulation.
- Never dip the electrode in water for cooling.
- Never simultaneously touch electrically “hot” parts of electrode holders connected to two welders because voltage between the two can be the total of the open circuit voltage of both welders.
- When working above floor level, use a safety belt to protect yourself from a fall should you get a shock.



**FUMES AND GASES CAN BE DANGEROUS.**

- Welding may produce fumes and gases hazardous to health. Avoid breathing these fumes and gases. When welding, keep your head out of the fume. Use enough ventilation and/or exhaust at the arc to keep fumes and gases away from the breathing zone. When welding with electrodes which require special ventilation such as stainless or hard facing or on lead or cadmium plated steel and other metals or coatings which produce highly toxic fumes, keep exposure as low as possible and below Threshold Limit Values using local exhaust or mechanical ventilation. In confined spaces or in some circumstances, outdoors, a respirator may be required. Additional precautions are also required when welding on galvanized steel.
- Do not weld in locations near chlorinated hydrocarbon vapors coming from degreasing, cleaning or spraying operations. The heat and rays of the arc can react with solvent vapors to form phosgene, a highly toxic gas, and other irritating products.
- Shielding gases used for arc welding can displace air and cause injury or death. Always use enough ventilation, especially in confined areas, to insure breathing air is safe.
- Read and understand the manufacturer’s instructions for this equipment and the consumables to be used, including the material safety data sheet and follow your employer’s safety practices.



**ARC RAYS CAN BURN.**

- Use a shield with the proper filter and cover plates to protect your eyes from sparks and the rays of the arc when welding or observing open arc welding.
- Use suitable clothing made from durable flame-resistant material to protect your skin and that

of your helpers from the arc rays.

- Protect other nearby personnel with suitable, non-flammable screening and /or warn them not to watch the arc nor expose themselves to the arc rays or to hot spatter or metal.



### **SELF-PROTECTION**

- Keep all equipment safety guards, covers and devices in position and in good repair. Keep hands, hair, clothing and tools away from V-belts, gears, fans and all other moving parts when starting, operating or repairing equipment.
- Do not put your hands near the engine fan. Do not attempt to override the governor or idler by pushing on the throttle control rods while the engine is running.



**DO NOT** add the fuel near an open flame welding arc or when the engine is running. Stop the engine and allow it to cool before refueling to prevent spilled fuel from vaporizing on contact with hot engine parts and igniting. Do not spill fuel when filling tank. If fuel is spilled, wipe it up and do not start engine until fumes have been eliminated.



### **WELDING SPARKS can cause fire or explosion.**

- Remove fire hazards from the welding area. If this is not possible, cover them to prevent the welding sparks from starting a fire. Remember that welding sparks and hot materials from welding can easily go through small cracks and openings to adjacent areas. Avoid welding near hydraulic lines. Have a fire extinguisher readily available.
- Where compressed gases are to be used at the job site, special precautions should be used to prevent hazardous situation.
- When not welding, make certain no part of the electrode circuit is touching the work or ground. Accidental contact can cause overheating and create a fire hazard.
- Do not heat, cut or weld tanks, drums or containers until the proper steps have been taken to insure that such procedures will not cause flammable or toxic vapors from substances inside. They can cause an explosion even though they have been “cleaned”.
- Vent hollow castings or containers before heating, cutting or welding. They may explode.
- Sparks and spatter are thrown from the welding arc. Wear oil free protective garments such as leather gloves, heavy shirt, cuff less trousers, high shoes and a cap over your hair. Wear ear plugs when welding out of position or in confined places. Always wear safety glasses with side shields when in a welding area.

- Connect the work cable to the work as close to the welding area as practical. Work cables connected to the building framework or other locations away from the welding area increase the possibility of the welding current passing through lifting chains, crane cables or other alternate circuits. This can create fire hazards or overheat lifting chains or cables until they fail.



### **Rotating parts may be dangerous.**

- Use only compressed gas cylinders containing the correct shielding gas for the process used and properly operating regulators designed for the gas and pressure used. All hoses, fittings, etc. should be suitable for the application and maintained in good condition.
- Always keep cylinders in an upright position securely chained to an undercarriage or fixed support.
- Cylinders should be located:
  - Away from areas where they may be struck or subjected to physical damage.
  - A safe distance from arc welding or cutting operations and any other source of heat, sparks, or flame.
- Never allow the electrode, electrode holder or any other electrically “hot” parts to touch a cylinder.
- Keep your head and face away from the cylinder valve outlet when opening the cylinder valve.
- Valve protection caps should always be in place and hand tight except when the cylinder is in use or connected for use.

## **§1.3 The knowledge of Electric and Magnetic Fields**

Electric current flowing through any conductor causes localized Electric and Magnetic Fields (EMF). The discussion on the effect of EMF is ongoing all the world. Up to now, no material evidences show that EMF may have effects on health. However, the research on damage of EMF is still ongoing. Before any conclusion, we should minimize exposure to EMF as few as possible.

In order to minimize EMF, we should use the following procedures:

- Route the electrode and work cables together – Secure them with tape when possible.
- All cables should be put away and far from the operator.
- Never coil the power cable around your body.
- Make sure welding machine and power cable to be far away from the operator as far as possible according to the actual circumstance.
- Connect the work cable to the workpiece as close as possible to the area being welded.
- The people with heart-pacemaker should be away from the welding arc.

## § 2 Summary

This operation manual is suitable for the model YT-81351.

### §2.1 Brief Introduction

YT-series welders are general MMA arc welder which adopts the latest pulse width modulation (PWM) technology and the insulated gate bipolar transistor (IGBT) power module. It uses digital control system. It can change work frequency to medium frequency so as to replace the traditional hulking work frequency transformer with the cabinet medium frequency transformer. Thus, it is characterized with portable, small size, low consumption and etc.

YT-series have excellent performances: real time display and current preset makes it convenient to use; fan demand makes the machine save the energy; constant current output makes welding arc more stable; fast dynamic response speed reduces the impact from the arc length fluctuation to the current; accurate stepless current adjustment and pre-setting function. There are also some automatic protection functions for under voltage, over heat, etc. inside the welders, when the problems listed before occurred, the alarm on the front panel is light and at the same time the output current will be cut off. It can self-protect and prolong the using life and greatly improved the reliability and practicability of the welders.

MMA——Manual Metal Arc welding;

PWM——Pulse-Width Modulation;

IGBT——Insulation Gate Bipolar Transistor;

### §2.2 Working Principle

The working principle of YT-81351 welder is shown as the following figure. Double phase 100V-120V  $\pm$  10%, 220V-240V  $\pm$  10% work frequency (50/60 Hz) AC is rectified into DC (about 300V), then is converted to medium frequency AC (about 20KHz) by inverter device (IGBT module), after reducing voltage by medium transformer (the main transformer) and rectified by medium frequency rectifier (fast recovery diodes), and is outputted by inductance filtering. The circuit adopts current



feedback control technology to insure current output stably. Meanwhile, the welding current parameter can be adjusted continuously and steplessly to meet with the requirements of welding craft.

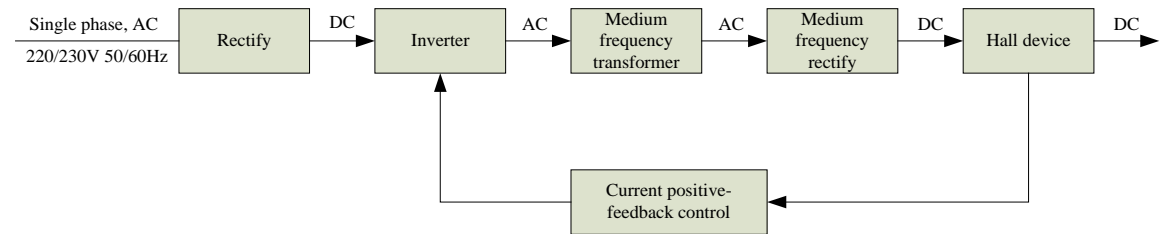

### §2.3 Volt-Ampere Characteristic

YT-series welders have excellent volt-ampere characteristic, seeing the following graph. In MMA welding, the relation between the rated loading voltage  $U_2$  and welding current  $I_2$  is as follows:

$$\text{When } I_2 \leq 600\text{A, } U_2 = 20 + 0.04 I_2 \text{ (V); When } I_2 > 600\text{A, } U_2 = 44 \text{ (V) .}$$

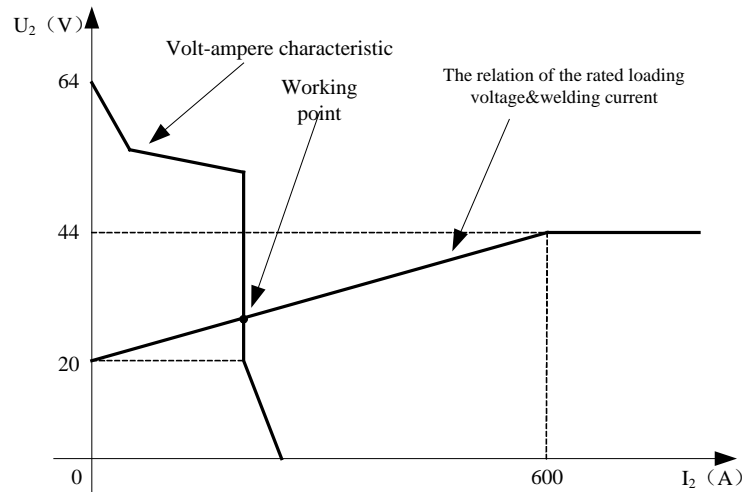

## § 3 Installation & Adjustment

### §3.1 Parameters

Models	YT-81351
<b>Parameters</b>	
Input power	Single phase, 220-240V±10%/,100V~120V±10%, 50/60Hz
Rated input current (A)	38.6A/110V, 28.4A/230V
Rated input power (KW)	4.3/110V, 6.7/230V
Power factor	0.8
Welding current range (A)	20A~110A/110V, 20A~160A/230V
Max no-load voltage(V)	53V/110V, 70V/230V
Efficiency	≥80%
Duty cycle (40°C, 10 minutes, refer to § 3.2)	110A/20%/110V, 160A/25%/230V
	55A/100%/110V, 80A/100%/230V,
Protection class	IP21s
Insulation class	F
Dimensions of Machine (L×W×H) (mm)	240*100*200

Note:

1. The above parameters are subject to change with the improvement of machines.

### §3.2 Duty cycle & Over heat

The letter “X” stands for duty cycle, which is defined as the proportion of the time that a machine can work continuously within a certain time (10 minutes). The rated duty cycle means the proportion of the time that a machine can work continuously within 10 minutes when it outputs the rated welding current.

The relation between the duty cycle “X” and the output welding current “I” is shown as the right figure.

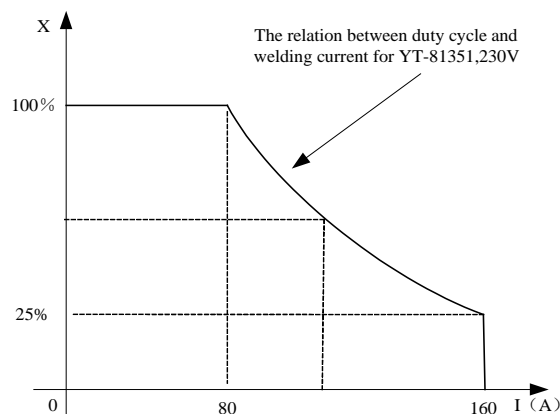

If the welder is over-heat, the IGBT over-heat protection unit inside it will output an instruction to cut output welding current, and brighten the over-heat pilot lamp on the front panel. At this time, the machine should be relaxed to cool the fan. When operating the machine again, the welding output current or the duty cycle should be reduced.

### § 3.3 Welding polarity connection way

#### §3.3.1 MMA

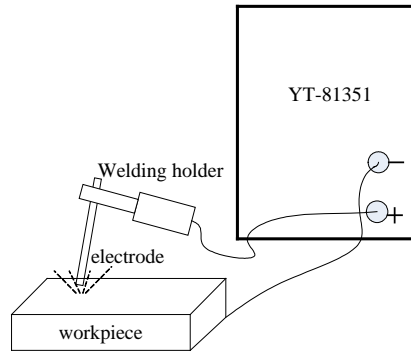

DCEP

Connection DCEP is only supported.

## § 4 Operation control and connectors

### § 4.1 Layout for front & rear panel

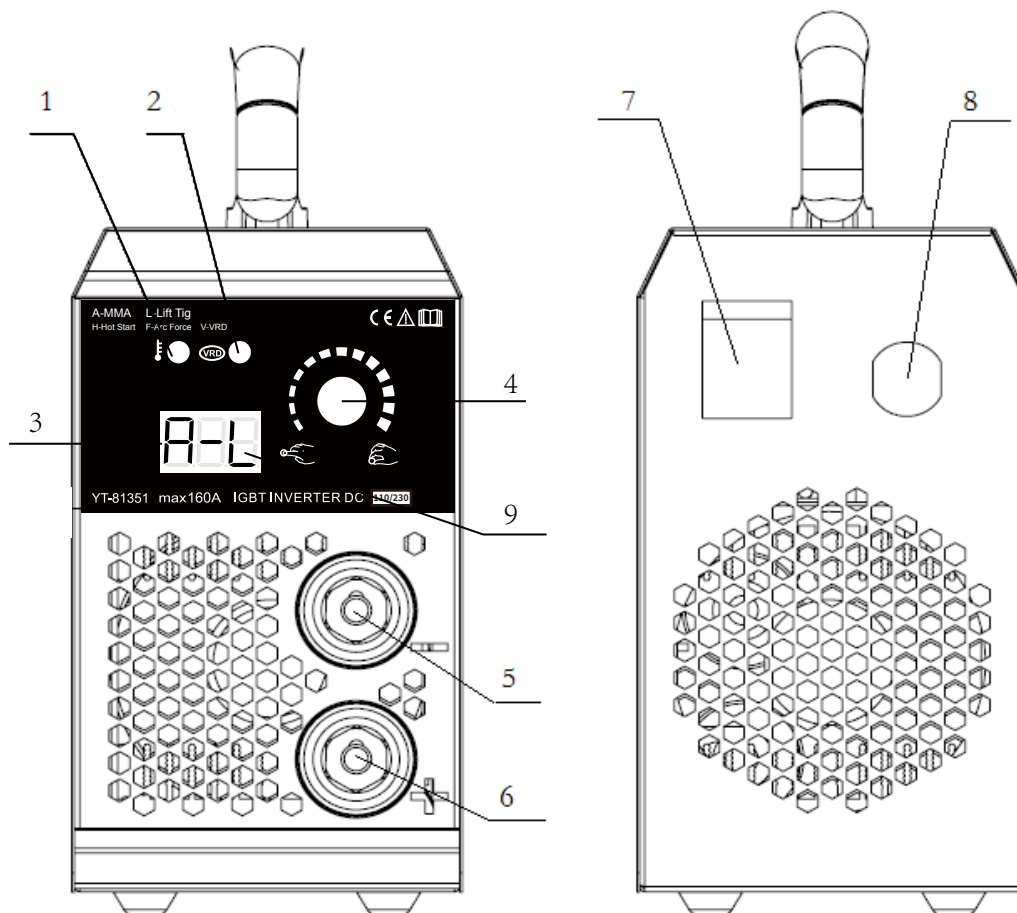

- |                       |  |
|-----------------------|--|
| 1) Alarm lamp         | Over-heat or over-current.   |
| 2) VRD lamp           | VRD parameter indicator lamp.  |
| 3) Value display      | Display the pre-setting and realtime parameter value.                          |
| 4) Encoder knob       | Set welding parameter values.  |
| 5) Earth connection   | Negative polarity output   |
| 6) Welding connection | Positive polarity output   |
| 7) Mains switch       |  |
| 8) Cable clamp        | Fastened the mains cable   |
| 9) A-L                | When "A" is flashing, it means MMA.<br>When "L" is flashing, it means LIFT TIG |

## § 4.2 parameters adjustment

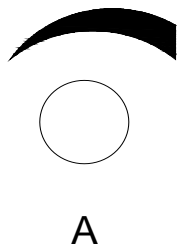

Welding current range is 20A~160A. Hot start current range is 0%~99%. Arc force value range is 0%~99%.

YT-series welder has the pre-setting function of welding current, hot start current, arc force value. Before welding, pitching the parameter options by pressing encoder key and adjusting parameter values by turn the knob, the parameter values will be show on the display. It is convenient to set parameters and adjust accurately.

## §4.3 Welding operation

### §4.3.1 Striking arc way

- Knocking arc: take the electrode upright to touch the workpiece, after forming short circuit, quickly lift up about 2~4 mm, and arc will be ignited. This method is difficult to master. But in the welding for the brittle or hard steel, it is better to use knocking way.
- Lifting arc: take the electrode to scrape the workpiece for striking arc. But it may cause the arc scratch, so must to lift arc in the groove.

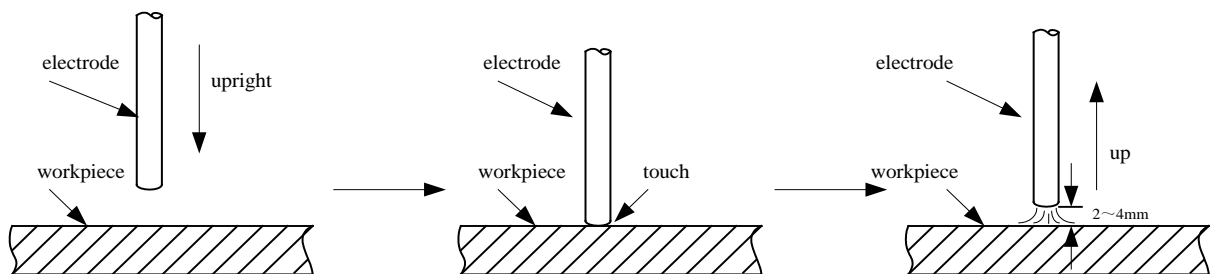

Take the electrode upright

The Electrode touch the workpiece

Lift up for about 2-4mm

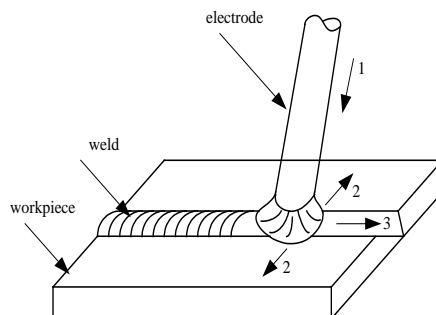

1-electrode moving; 2-the electrode swing right & left; 3-the electrode move along weld

### §4.4.2 Manipulation of electrode

In MMA welding, there are three motions to be matched in the end of electrode: the electrode moving to the molten pool along axes; the electrode swing right and left; the electrode moving along welding way.

The operator can choose the manipulation of electrode based on welding joint sharp, welding position, electrode spec, welding current and operation skill, etc. The details please refer to 《Welding Dictionary》 P69, Volume 1 of Edition 2.

## §4.4 Welding parameters

### §4.4.1 Joint form in MMA

In MMA welding, the common basic joint form: butt joint, lap joint, corner joint & T joint.

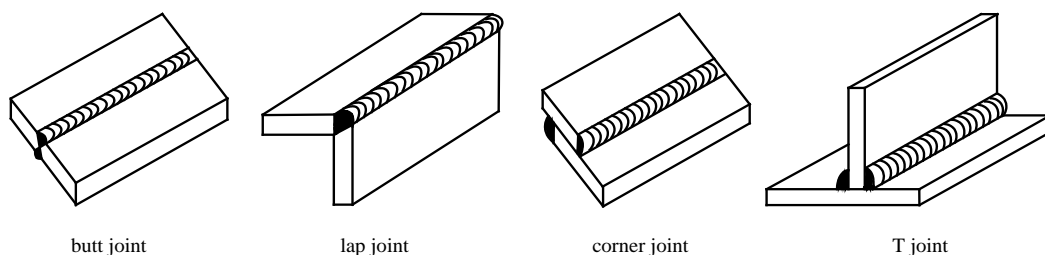

### §4.4.2 Electrode selection

The electrode diameter selection is based on the workpiece thickness, welding position, joint form, welding layer, etc. Please refer to the following table.

The welding current reference for different electrode diameter				
Electrode diameter/mm	1.6	2.0	2.5	3.2
Welding current/A	25~40	40~60	50~80	100~130
The relation between the welding current(I)' factor(K) & electrode diameter(d) (I=K×d: Carbon electrode)				
Electrode diameter/mm	1.6	2~2.5	3.2	
Factor/K	20~25	25~30	30~40	

Notice: the above parameters originate from 《Welding Dictionary》 P66~P67, Volume 1 of Edition 2.

- Electrode should be drying according to user manual before using. For reducing

the hydrogen of the molten pool and welding seam, and avoiding the blowhole and cold crack.

- In the welding process, the arc must not be too long; otherwise, it will cause unstable arc burning, large spatter, light penetration, undercut, blowhole, etc. If the arc is too short, it will cause electrode stick.
- In MMA welding the arc length is usually equal to 0.5~1.0 time of the electrode diameter. The basic electrode's arc length is not beyond the electrode diameter, it's better to choose the short arc welding; the acid electrode's arc length is equal to the electrode diameter.

### §4.5 Arc Welding Defect and Prevent Method

Defect name	Caused reasons	Prevent methods
Welding seam doesn't meet the requirement	The groove angle is not proper The root face and assembly gap is not equal Welding technics parameters are unreasonable The welder's operation skill is lower	Choosing the proper groove angle & assembly gap, improve the assembly quality Choosing the proper welding parameters Improve the operation skill of welders
Undercut	Over current Arc length is too long The electrode angle is wrong Manipulation of electrode is not proper	Choosing the proper welding current & speed The arc can't be drawn too long The electrode angle should be proper Manipulation of electrode should be correct
Incomplete penetration	The groove angle or gap is too small, the root face is too big Welding parameters are not suitable, or the assembly is not good The welder's operation skill is lower	Correctly to choose and process the groove size Correctly to assemble and ensure clearance Choosing the suitable welding current & speed Improve the operation skill of welders
Incomplete fusion	The welding thermal input is too low The arc direction is lean There are rust & dust on the side of groove The slag between the layers is not cleared well	Correctly to choose the welding parameters Operation seriously Enhance the clearness of layers
Overlap	The temperature of molten pool is too high The liquid metal concretes slowly	Choosing parameters based on the welding different position Strictly to control the molten hole size
Crater	The crater time lasts too short Over current in the welding of thin plate	In the crater, electrode should be stayed for a short time or round to manipulate electrode after the molten pool is filled in by metal, take to the side for crater
Blowhole	There are some dust like oil, rust or water on the work piece surface and groove The coating of electrode is damped& is not drying Under current or over speed in the welding The arc is too long or lean burning, the molten pool protection is not good Over current, the coating of electrode falls off and lose protection Manipulation of electrode is not proper	Clear out the dust around groove for about 20~30mm Strictly to dry the electrode according to manual Correctly to choose parameters and to operate Using the short arc operation Welding operation in the field should have anti-wind protection Don't use the invalid electrode

Defect name	Caused reasons	Prevent methods
Welding seam doesn't meet the requirement	The groove angle is not proper The root face and assembly gap is not equal Welding technics parameters are unreasonable The welder's operation skill is lower	Choosing the proper groove angle & assembly gap, improve the assembly quality Choosing the proper welding parameters Improve the operation skill of welders
Undercut	Over current Arc length is too long The electrode angle is wrong Manipulation of electrode is not proper	Choosing the proper welding current & speed The arc can't be drawn too long The electrode angle should be proper Manipulation of electrode should be correct
Incomplete penetration	The groove angle or gap is too small, the root face is too big Welding parameters are not suitable, or the assembly is not good The welder's operation skill is lower	Correctly to choose and process the groove size Correctly to assemble and ensure clearance Choosing the suitable welding current & speed Improve the operation skill of welders
Incomplete fusion	The welding thermal input is too low The arc direction is lean There are rust & dust on the side of groove The slag between the layers is not cleared well	Correctly to choose the welding parameters Operation seriously Enhance the clearness of layers
Inclusion & slag inclusion	The slag clears bad in the middle layer in the welding process Under current or over speed in the welding Welding operation is not proper The welding material can not match the work piece The groove design & processing are not proper	Choosing the electrode of good slag detachability Strictly to clear the slag in the layers Correctly to choose the welding parameters Adjusting the electrode angle and manipulation way
Defect name	Caused reasons	Prevent methods
Hot crack	In the process of solidification, the inter crystal segregation is seriously caused. At the same time, with the effect of welding stress, the hot crack is formed.	Adjust the structure of welding material. Adopt the basic electrode.
Cold crack	Three reasons will cause cold crack: The structure turned from the marten site The residual stress caused by big restraint intensity The residual hydrogen in welding gap.	Adopt low hydrogen type basic electrode. Bake under the instruction before use. Remove the feculence before use, reduce the percentage of hydrogen Adopt appropriate parameters and heat input After welding, do dehydrogenation at once.

## §4.6 Operation Environment

- Height above sea level is below 1000m.
- Operation temperature range:-10<sup>0</sup>C~+40<sup>0</sup>C.
- Relative humidity is below 90 %( +20<sup>0</sup>C ).
- Preferably site the machine some angles above the floor level, the maximum angle does not exceed 15<sup>0</sup>.
- Protect the machine against heavy rain or in hot circumstance against direct sunshine.
- The content of dust, acid, corrosive gas in the surrounding air or substance can not exceed normal standard.
- Take care that there is sufficient ventilation during welding. There is at least 30cm free distance between the machine and wall.



## **§4.7 Operation Notices**

- Read §1 §4.2 carefully before attempting to use this equipment.
- Connect the ground wire with the machine directly.
- Input power must be AC as one phase, 50Hz, 220/240V or 100/120V. Forbid working in lacking any phase.
- In case closing the power switch, no-load voltage may be exported. Do not touch the output electrode with any part of your body.
- Before operation, no concerned people should be left. Do not watch the arc in unprotected eyes.
- Ensure good ventilation of the machine to improve duty ratio.
- Turn off the engine when the operation finished to economize energy sources.
- When power switch shuts off protectively because of failure. Don't restart it until problem is resolved. Otherwise, the range of problem will be extended.

## § 5 Maintenance & Troubleshooting

### §5.1 Maintenance

In order to guarantee that arc welding machine works high-efficiently and in safety, it must be maintained regularly. Let customers understand the maintenance methods and means of arc welding machine more , enable customers to carry on simple examination and safeguarding by oneself, try one's best to reduce the fault rate and repair times of arc welding machine, so as to lengthen service life of arc welding machine .Maintenance items in detail are in the following table.

- **Warning: For safety while maintaining the machine, please shut off the supply power and wait for 5 minutes, until capacity voltage already drops to safe voltage 36V.**

Date	Maintenance items
Daily examination	<p>Observe that whether panel knob and switch in the front and at the back of arc welding machine are flexible and put correctly in place. If the knob has not been put correctly in place, please correct; If you can't correct or fix the knob , please replace immediately;</p> <p>If the switch is not flexible or it can't be put correctly in place, please replace immediately; Please get in touch with our company maintenance service department if there are no accessories.</p> <p>After turn-on power, watch/listen to that whether the arc welding machine has shaking, whistle calling or peculiar smell. If there is one of the above problems, find out the reason to get rid of; if you can't find out the reason, Please contact local this area our company agent or the branch company.</p> <p>Observe that whether the display value of LED is intact. If the display number is not intact, please replace the damaged LED. If it still doesn't work, please maintain or replace the display PCB.</p> <p>Observe that whether the min/max value on LED accords with the set value. If there is any difference and it has affected the normal welding craft, please adjust it.</p> <p>Check up that Whether fan is damaged and is normal to rotate or control. If the fan is damaged, please change immediately. If the fan does not rotate after the arc welding machine is overheated , observe that whether there is something blocked in the blade, if it is blocked, please get rid of ; If the fan does not rotate after getting rid of the above problems, you can poke the blade by the rotation direction of fan. If the fan rotates normally, the start capacity should be replaced; If not, change the fan.</p> <p>Observe that whether the fast connector is loose or overheated. if the arc welding machine has the above problems, it should be fastened or changed.</p> <p>Observe that Whether the current output cable is damaged. If it is damaged, it should be wrapped up, insulated or changed.</p>
Monthly examination	<p>Using the dry compressed air to clear the inside of arc welding machine. Especially for clearing up the dusts on radiator, main voltage transformer, inductance, IGBT module, the fast recover diode and PCB, etc.</p>

	Check up the bolt in arc welding machine, if it is loose, please screw down it. If it is skid, please replace. If it is rusty, please erase rust on bolt to ensure it works well.
Quarter-yearly examination	Whether the actual current accords with the displaying value. If they do not accord, they should be regulated. The actual current value can be measured by the adjusted plier-type ampere meter.
Yearly examination	Measure the insulating impedance among the main circuit, PCB and case, if it below $1M \Omega$ , insulation is thought to be damaged and need to change, and need to change or strengthen insulation.

### § 5.2 Troubleshooting

- Before arc welding machines are dispatched from the factory, they have already been debugged accurately. So forbid anyone who is not authorized by our company to do any change to the equipment!
- Maintenance course must be operated carefully. If any wire becomes flexible or is misplaced, it maybe potential danger to user!
- Only professional maintenance personal who is authorized by our company could overhaul the machine!
- Guarantee to shut off the arc welding machine's power before turn on the outline of the equipment!
- If there is any problem and has no the authorized professional maintenance personal of our company, please contact local our company agent or the branch company!

If there are some simple troubles of YT-series welding machines, you can consult the following overhauling chart:

S/N	Troubles	Reasons	Solutions
1	Turn on the power source, and fan works, but the power light is not on.	The power light damaged or connection is not good	Test and repair the inside circuit of power light Pr3
		Power PCB failures	Repair or change power PCB Pr2
2	Turn on the power source, and the power light is on, but fan doesn't work	There is something in the fan	Clear out
		The fan motor damaged	Change fan motor
3	Turn on the power source, and the power light is not on, and fan doesn't work	No input voltage	Check whether there is input voltage
		Overvoltage (Input voltage is too much or not)	Check input voltage
4	No no-load voltage output	There is trouble inside the machine	Check the main circuit, Pr1 and Pr2
5	No current output in the welding	Welding cable is not connected with the two output of the welder.	Connect the welding cable to the welder's output
		Welding cable is broken	Wrap, repair or change the welding cable
		Earth cable is not connected or loosen	Check the earth clamp
6	Not easy to start arc in the welding, or easy to cause sticking	The plug loosen or connect not well	Check and tighten the plug
		Oil or dust covered the workpiece	Check and clear out
		MMA/TIG welding selection is wrong	Selecting the MMA welding
7	The arc is not stable in the welding process	The arc force is too small	Increase the arc force
8	The welding current can not be adjusted	The welding current potentiometer in the front panel connection not so good or damaged	Repair or change the potentiometer
9	The penetration of molten pool is not enough(MMA)	The welding current adjusted too low	Increase the welding current
		The arc force adjusted too small	Increase the arc force
10	Arc blow	Airflow disturbance	Use the shelter from airflow
		The electrode eccentricity	Adjust the electrode angle
			Change the electrode
		Magnetic effect	Incline the electrode to the opposite way of the magnetic blow
			Change the position of earth clamp or add earth cable in the two side of workpiece
Use the short arc operation			

11	The alarm light is on	Over heat protection	Over welding current	Induce the welding current output
		Over current protection	Working time too long	Induce the duty cycle (interval work)
			Unusual current in the main circuit	Test and repair the main circuit and drive PCB (Pr1)

## §5.3 Electrical principle drawing

