

Portable Power Station

P500 User Manual

P500 Portable Power Station

No worries about outside of short of power any more. With portable power station solar generator, you can easily stay charged while on-the-go. No worries about suddenly power cuts any more. No worries about outdoor dark night any more. portable Power Station offers you great power supply and confidence in the wild!

ATTENTION

- A. Specifications and images in this manual are for reference only.
- B. The product is only used for emergency situation, it cannot replace the standard AC power for household appliances or digital products.
- C. Actual AC outlets and the AC adapter would be different depending on the location of the customer.
- D. Fully charge the product before using it for the first time (minimum 10 hours), the battery bar no longer flashes is indicated fully charged.

Get To Know Your Product

1. Front

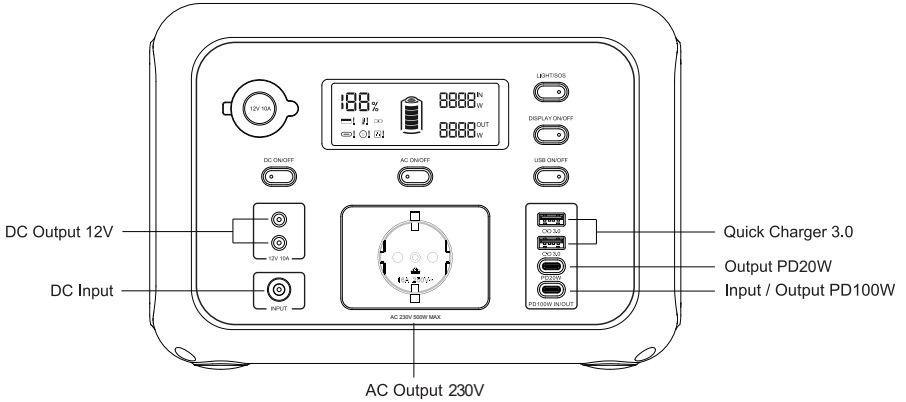

Charging Your Product

⚠ ATTENTION

If the ambient temperature is too high or the battery temperature is higher than 60 °C due to continuous high-power discharge, the product cannot be chained. When the battery temperature is less than 55 °C, the charging function will automatically resume. If it is not used for a long time, it is best to fully charge it every three months before storing; It is best to fully charge each charging.

1. LCD Battery Display

There are 5 segments to the battery, approximating 20%-40%-60%-80%-100% capacity. As you use your product, segments will disappear from the display, indicating the remaining charge. When charging your product you will notice a battery segment blinking at a 1 second interval status. Once your products is fully charged, all battery segments will be lit and remain solid.

2. Charge Through Solar Panel

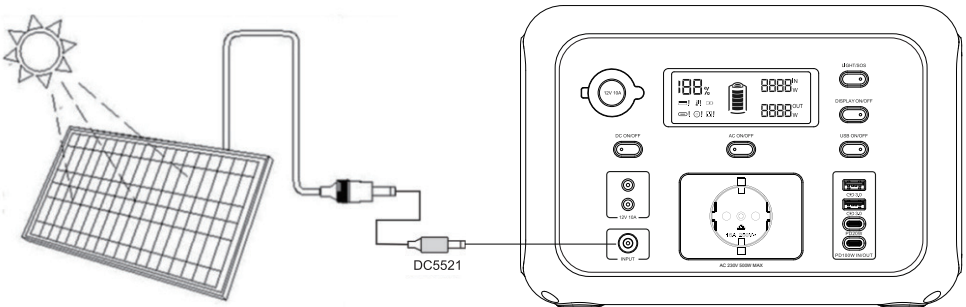

- A. Place your solar panel where it will get as much strong direct sunlight as possible.
- B. Connect the output port of the solar panel with the input port of the product to start charging. You will know the product is being charged when the LCD display indicators blink. The product is fully charged when all battery indicators stop blinking and remain solid.

⚠ Notes:

The actual charging efficiency can vary widely depending on weather, ambient temperature, sunlight's strength, the angle that the solar panels faces to the straight sunlight and other factors. The maximum output voltage of the solar panel should not exceed 23.5V. In order to ensure solar charging efficiency, it is recommended to use solar panels with an open circuit output voltage of 10.8-23.5V.

3. Charge Through AC Adapter

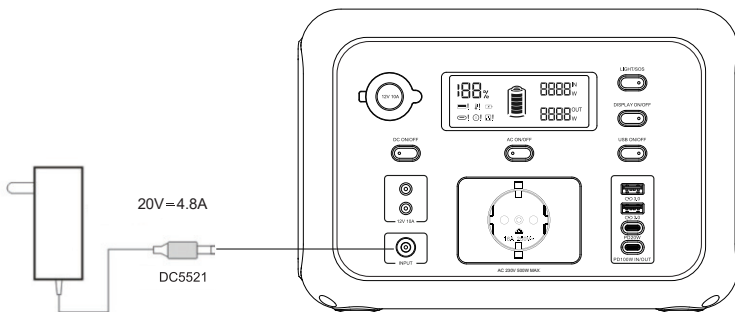

Plug the original adapter into the machine's DC input port and you will see the battery indicators on the screen blink.

⚠ Notes:

- A. The product is fully charged when all battery indicators stop blinking and remain solid. After the product is fully charged, please unplug the AC wall chafe in time.
- B. Usually, it takes around 7 hours to fully charge the machine using the AC power adapter.

4. Charge Through Your Car

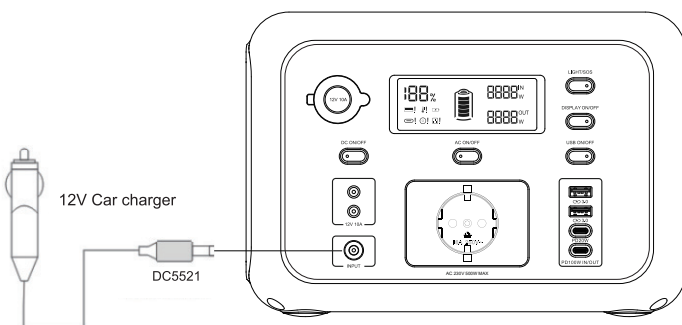

- A. Plug the original car charger into the cigarette lighter socket of your 12V car, and then plug into the DC input port of the machine.
- B. The original car charger features 10A protector tube to protect your car.
- C. You will know the machine is being charged when the battery indicators blink.

⚠ Notes:

To avoid car battery power loss, you should charge this product through your car cigarette lighter only when your car engine is started. This function is for 12V car only.

Protection mode(DC input)

- A. Due to the different models of your car, it may not be full.
- B. Under-voltage protection: The power generator can't be charged if the voltage of your car is too low.

**5. Charge Through PD Charger
(PD charger no include)**

Plug your PD charger to the PD 100W IN/OUT Dock.

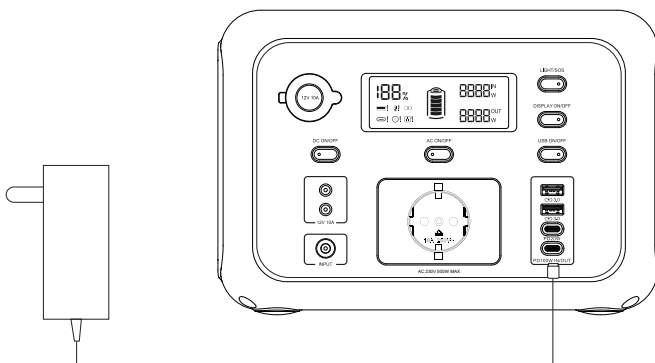



PD charger(not include)

Using Your Product

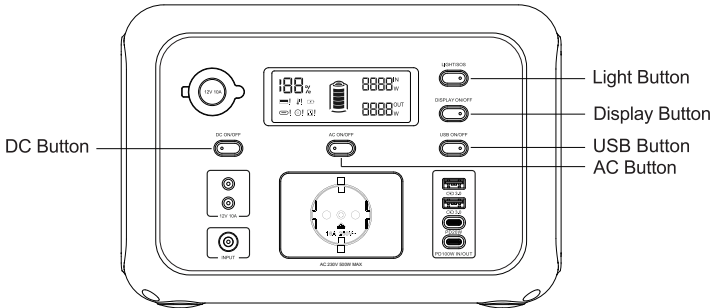
1. Button



- A. Press any key to turn it on.
- B. Press the AC button to turn on the AC function (The  icon will display on the screen at the same time.) Press the AC button again to turn off the AC function when no use. Long press the AC button to turn off the sound.
- C. Press the DC button to turn on the DC function (The  icon will display on the screen at the same time.) Press the DC button again to turn off the DC function when no use.
- D. Press the display button to turn off the screen display, Press the display button again to turn on the screen display.
- E. Press the Display button and AC button simultaneously to switch the frequency of the machine;
- F. Press the Display button and Light button simultaneously to reset the machine;
- G. Press the USB button to turn on the USB function, Press the USB button again to turn off the USB function.

2. Light Modes

- A. Press this button to turn on the light, high-light mode.
- B. Press this button again to change the light mode into low-light mode.
- C. Press this button again to turn off the light.
- D. Press this button 3S to change the light mode into SOS.
- E. Press this button again to turn off the light.

 **Warning! DO NOT stare the light straightly!**

3. USB Outputs Function

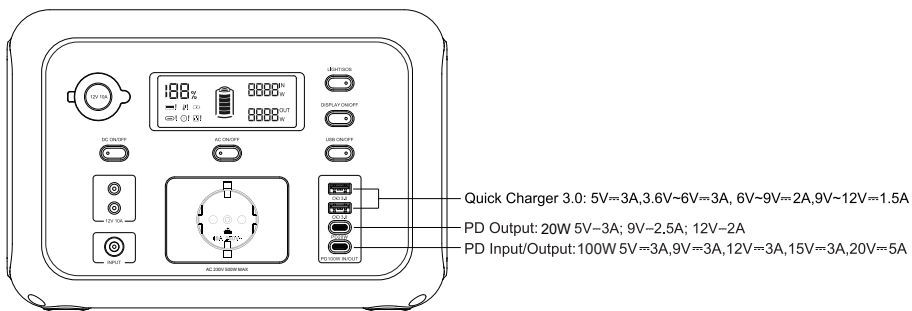

4. DC Outputs Function

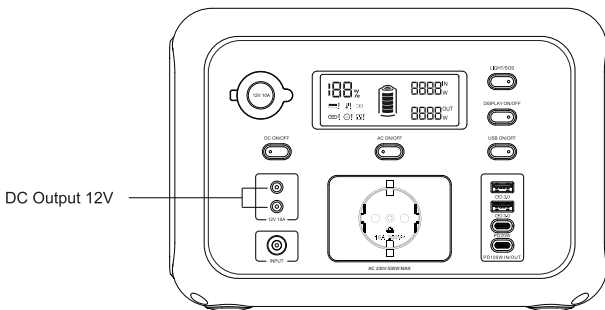

- A. These two DC5521(5.5mm in diameter) 12V port offer max 10A output current and automatically distributing max curme.
- B. Each of DC5521 ports can be connected with an cigarette lighter(power requires no more than 120W).

⚠ Notes:

When the product's AC, DC, and USB output at the same time, and the battery current is greater than 43A, after 3 minutes of operation, the product's buzzer will alarm, and the LCD screen will display the [!]. If the alarm continues for more than 30 seconds, it has not been cleared, the product will forcibly turn off the DC output to reduce the total output current of the battery and ensure the safety of the product, when the DC output is turned off due to overload, please do not force it to turn on again by pressing the button. When the battery voltage is less than 5%, the DC and AC outputs function will be forcibly closed, and it needs to be charged to release it.

Protection mode(DC outputs)

Short circuit protection: when short-circuit occurs to the external devices, the machine starts beeping and stops charging.

5. AC Outputs Function

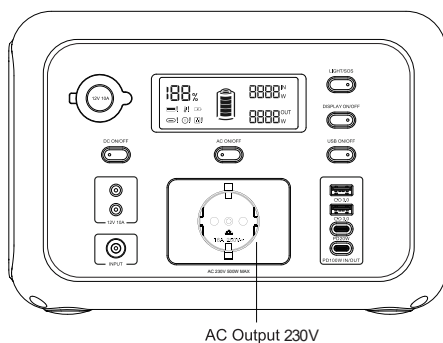

- Plug the power cable of AC appliance into the AC outlet of the P500. Press the power button to enter AC mode.
- Make sure the power of the connected AC appliance is less than 500W.

⚠ Notes:

When there is no operation, the LCD screen backlight will automatically become dim after 10S minutes. When the machine is not working, it will automatically shut down. When the battery voltage is less than 5%, the AC output function will be forcibly closed, and it needs to be charged to be released.

Protection mode:(AC output)

A. This product has undervoltage protection; overload protection; short circuit protection; The overtemperature protection adopts double isolation circuit, which is safe, reliable and efficient.

B. When overload, over temperature or short circuit occurs, this machine will start beeping and the ! appears on the screen, and then the AC function automatically shuts down to ensure safety.

Product Specifications

Battery

Battery	LiFePO4 Battery
Battery Capacity	518Wh
Lifecycles	2000 Cycles
Battery Maintenance	Charge Every 3-6 Months

Port

USB Port (Output)	5V \approx 3A; 9V \approx 2A; 12V \approx 1.5A
USB-C Port (Output) ^{power}	5V \approx 3A; 9V \approx 2.5A; 12V \approx 2A
USB-C Port (Output/Input)	5V \approx 3A; 9V \approx 3A; 12V \approx 3A; 15V \approx 3A; 20V \approx 5A
5.5mm Port (Output, 5.5mm)	12V \approx 10A
AC Port (Output)	500W Pure Sine Wave
Charging Port(Input,5.5mm)	Adapter: DC 20V \approx 4.8A Solar Panel: 10.8~23.5V

General

Weight	6.5 \pm 0.5kg
Dimensions	274*188*185mm
Operating Usage Temp	0°C~40°C
Illumination	1 Ultra-bright LED

Cold Weather Usage

Cold temperatures (0°C~40°C) can affect the product's battery capacity due to chemical characteristics of the battery. If you'll be living off grid in sub-zero conditions, it is recommended to keep your product in an insulated cooler, and connected to a power source (12V car/AC adapter/solar panel). The natural heat generated by the product contained in an insulated cooler will keep battery capacity at its highest level.

Disposal And Recycle

This product should not be disposed along with household waste. Please dispose or recycle this product and the battery inside according to the local rules and regulations.

Battery Information

A. This product has an internal, non-removable, LiFePO4 Rechargeable battery. Do not attempt to remove the battery, as you may damage the device.

B. The battery can be charged and discharged over 2000 cycle times.

FAQ

Q1: Which devices can this P500 portable power station support?

A: AC output: Rated 500W; DC output: 12V/10A (120W max);

Q2: Does P500 power station support pass through charging?

A: Yes, this P500 portable power station support pass through charging, you can use all other outputs while charging.

Q3: Does the product have a power saving function?

A: Yes, our power station have a power saving function:

For the DC output, when the output is less than 50mA, the power station will shut down automatically after 4 hours.

For the USB output, when the output is less than 30mA, the power station will shut down automatically after 10 seconds.

Q4: How to remove the button beep?

A: Press the AC button 3-5 seconds, the beeping sound will be removed. Press the AC light button 3-5 seconds to restore the sound.

Caution

1. Do not short-circuit the product. To avoid short-circuiting, keep the product away from all metal objects.
2. Do not heat the product, or dispose it in fire, water or other liquids. Keep it away from high ambient temperature. Do not expose the product to direct sunlight.
3. Keep the product away from humid, dusty places.
4. Do not disassemble or reassemble this product.
5. Do not drop, place heavy objects on, or allow strong impact to this product.
6. This product is not intended to be used by person with reduced physical, sensory or mental capabilities.
7. Please keep this product away from children.
8. Do not cover the product with towels, clothing and other item.
9. Do not overcharge this product.
10. When fully charged, disconnect the product from the power source immediately.
11. If you are not going to use this product for a long time, please disconnect the cable before storing it away.
12. To charge some portable electronic devices, you may need to set those devices in charge mode first. Refer the corresponding user manual of those devices for confirmation.

Pure Sine Wave Output

This product generates Pure sine wave, which is compatible with AC electric appliance that works with Sinusoidal waveform (power<500W). However, the product is only used for emergency situations. It cannot replace the standard DC or AC power supply for household appliances or digital products.

Package Content

- 1 x P500 Portable Power Station
- 1 x AC Adapter
- 1 x User Manual

Warranty

Our company provides customers with warranty of 12 months from the date of purchase.



Made in China