



利 帅 影 视



YUYAO LISHUAI FILM &
TELEVISION EQUIPMENT CO.,LTD

Add:No.55 East Zhenxing Road,Yuyao City,Zhejiang Province,China
Tel:+86-574-62763333/62636368 Fax:+86-574-62636398
Email:ls@lishuai.com.cn
Http:// www.lishuai-lighting.com www.led-studiolights.com

**LISHUAI FILM &
TELEVISION EQUIPMENT**

CONTENTS

About us

ENTERPRISE INTRODUCTION

Established in 2003, Yuyao Lishuai Film & Television Equipment Co., Ltd is a high-tech enterprise integrating R&D, production and sales of LED photo and video lighting equipments and accessories, and has passed ISO9001 certification.

Since 2006, the company has been mainly committed to the application of various LED lights in the film and photography industries. Up to now, the LS brand and products are specially preferred by film crews, program groups, TV stations, advertisers, lighting engineers, photographers and cameramen.

During the company's development, we adhered to the principle of "taking honesty as foundation, self-surpassing and creative". By present the company has obtained 2 Invention patents, 36 Utility Model patents and Design patents and has been recognized as a "National High-tech Enterprise" for three years since 2014. Every year the company develops sino-foreign cooperation projects and by now has cooperated with several well-known enterprises at home and abroad and has achieved good results. By now the company's current products have passed CE certification.

By steady efforts, our products have been sold far to Europe, America, Middle East, Southeast Asia and Hong Kong, Macao and Taiwan regions, many provinces and cities in china. Customer's trust is always our company's pursue and company's development is inseparable from the support of customers. We sincerely welcome you to join us for future development.

Enterprise environment	01-02
HUESCAPE LED RGB Light.....	03-10
High Power LED Panel Light.....	11-15
Victorsoft High Power LED Light.....	16-18
LED Edge Light	19-21
LED Foldable light	22-28
LED Panel light	29-30
LED On-camera light	31-32
Accessories	33-39

WE ALWAYS SEEK TO DO BETTER

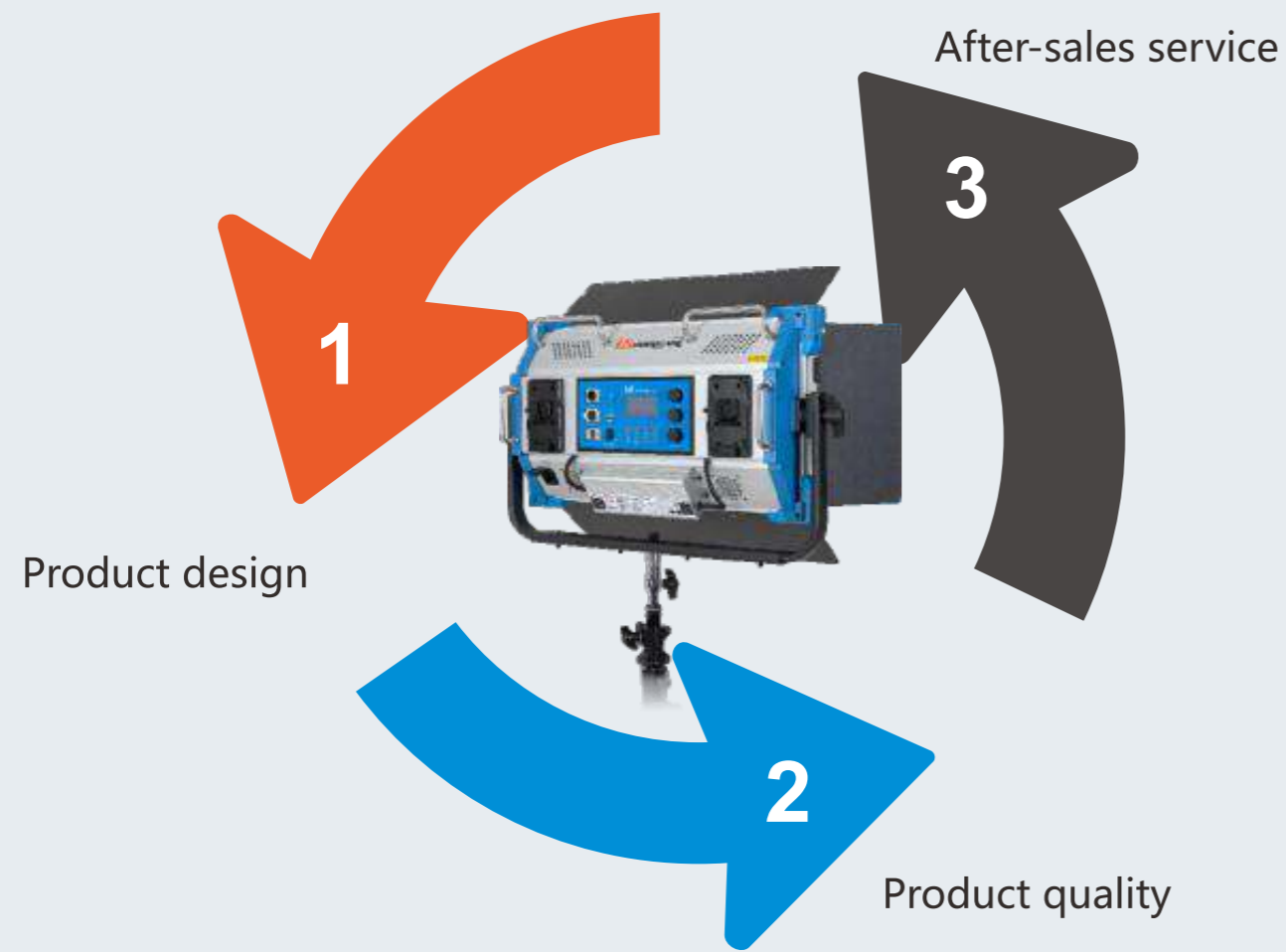

Taking honesty as foundation
self-surpassing and creative





LISHUAI FILM & TELEVISION EQUIPMENT



HUESCAPE LED RGB Light

HUESCAPE LED RGB LIGHT

HS-1200



LED diffusion	Lishuai Huescape Technology
Front diffuser panel	87x130cm
Beam angle	120°
Color light	Full RGB+W gamut with hue saturation control
Dimming	0-100% continuous
White light	Continuously adjustable 2800K to 10000K
CRI,TLCI	CRI ≥95,TLCI ≥91
Color temperature error	± 200K
Remote control	DMX 512,Remote control,Mobile APP
Power input	AC100-240V
Power output	1400W max
Working temperature	-4 to 113° F (-20°C to 45°C)
Protection level	IP20
LED lifetime	Up to 50,000 hours
Weight	143lbs (65kg)
Dimensions	58in x 44in x 7.2in (147.5x112x18.2cm)

[Characteristics:]

- Fully adjustable color temperature from 2800K to 10000K.
- Complete 0-360° color selection (RGB+W color gamut).
- Fully dimmable from 0 to 100%.
- Multiple pre-programmed scenes and effects.
- High CRI ≥95 and TLCI ≥91.
- With USB automatic upgrade function, easy to add subsequent functions.
- Mobile APP is available to adjust various parameters of the light.
- DMX 512 compatible.
- Suitable for TV and movie shooting, various scene photography.



HS-600S



LED diffusion	Lishuai Huescape Technology
Front diffuser panel	42x75cm
Beam angle	120°
Color light	Full RGB+W gamut with hue saturation control
Dimming	0–100% continuous
White light	Continuously adjustable 2800K to 10000K
CRI,TLCI	CRI ≥95,TLCI ≥91
Color temperature error	± 200K
Remote control	DMX 512,Remote control,Mobile APP
Power input	AC100–240V,50/60Hz,DC48V
Power output	600W max
Working temperature	–4 to 113° F (–20°C to 45°C)
Protection level	IP20
LED lifetime	Up to 50,000 hours
Weight	47.6lbs (21.6kg)
Dimensions	36.2in x 21.5in x 7.2in (92x54.4x18.2cm)



HS-600

LED diffusion	Lishuai Huescape Technology
Front diffuser panel	30x130cm
Beam angle	120°
Color light	Full RGB+W gamut with hue saturation control
Dimming	0–100% continuous
White light	Continuously adjustable 2800K to 10000K
CRI,TLCI	CRI ≥95,TLCI ≥91
Color temperature error	± 200K
Remote control	DMX 512,Remote control,Mobile APP
Power input	AC100–240V,50/60Hz,DC48V
Power output	600W max
Working temperature	–4 to 113° F (–20°C to 45°C)
Protection level	IP20
LED lifetime	Up to 50,000 hours
Weight	57.3lbs (26kg)
Dimensions	57.9in x 20.4in x 7.2in (147x51.8x18.2cm)



[Characteristics:]

- All-aluminum frame makes it to have better heat dissipation and longer working life.
- Fully adjustable color temperature from 2800K to 10000K.
- Complete 0–360° color selection (RGB+W color gamut).
- Fully dimmable from 0 to 100%.
- Multiple pre-programmed scenes and effects.
- High CRI ≥95 and TLCI ≥91.
- With USB automatic upgrade function, easy to add subsequent functions.
- Mobile APP is available to adjust various parameters of the light.
- DMX 512 compatible.
- Suitable for film and TV shooting, studio, advertising shooting, shooting of various characters and scenes, including portrait photography, wedding photography, childrens' photography, etc.

HS-120

LED diffusion	Lishuai Huescape Technology
Front diffuser panel	48x25cm
Beam angle	120°
Color light	Full RGB+W gamut with hue saturation control
Dimming	0–100% continuous
White light	Continuously adjustable 2800K to 10000K
CRI,TLCI	CRI:95–98,TLCI:95–97
Color temperature error	± 100K
Remote control	DMX 512,Remote control,Mobile APP
Power input	AC100–240V,50/60Hz,DC15V
Power output	120W max
Battery mount	V-lock plate
Battery voltage	DC12–17V
Battery mode power output	0–80%
Working temperature	–4 to 113° F (–20°C to 45°C)
Protection level	IP20
LED lifetime	Up to 50,000 hours
Weight	14.3lbs (6.47Kg)without adapter, 15.8lbs (7.17Kg) with adapter
Dimensions	26.4in x 18.7in x 3.1in (67x47.5x8cm)



HS-150

LED diffusion	Lishuai Huescape Technology
Front diffuser panel	30x30cm
Beam angle	120°
Color light	Full RGB+W gamut with hue saturation control
Dimming	0–100% continuous
White light	Continuously adjustable 2800K to 10000K
CRI,TLCI	CRI ≥95,TLCI ≥91
Color temperature error	± 200K
Remote control	DMX 512,Remote control,Mobile APP
Power input	AC100–240V,50/60Hz,DC15V
Power output	150W max
Battery mount	V-lock plate
Battery voltage	DC12–17V
Battery mode power output	0–80%
Working temperature	–4 to 113° F (–20°C to 45°C)
Protection level	IP20
LED lifetime	Up to 50,000 hours
Weight	25.4lbs (11.5kg)
Dimensions	18.5in x 20.4in x 7.2in (47x51.8x18.2cm)



[Characteristics:]

- All-aluminum frame makes it to have better heat dissipation and longer working life.
- Fully adjustable color temperature from 2800K to 10000K.
- Complete 0–360° color selection (RGB+W color gamut).
- Fully dimmable from 0 to 100%.
- Multiple pre-programmed scenes and effects.
- High CRI 95–98 and TLCI 95–97.
- External battery can be loaded for outside using.
- With USB automatic upgrade function, easy to add subsequent functions.
- Use LCD screen display to facilitate users to observe data.
- LED heat-free technology assures the stable, consistent and accurate lighting output.
- Mobile APP is available to adjust various parameters of the light.
- DMX 512 compatible.
- Suitable for film and TV shooting, studio, advertising shooting, shooting of various characters and scenes, including portrait photography, wedding photography, childrens' photography, etc.



HS-300



LED diffusion	Lishuai Huescape Technology
Front diffuser panel	30x60cm
Beam angle	120°
Color light	Full RGB+W gamut with hue saturation control
Dimming	0-100% continuous
White light	Continuously adjustable 2800K to 10000K
CRI, TLCI	CRI ≥ 95, TLCI ≥ 91
Color temperature error	± 200K
Remote control	DMX 512, Remote control, Mobile APP
Power input	AC100-240V, 50/60Hz, DC30V
Power output	320W max
Battery mount	V-lock plate
Battery voltage	DC24-36V
Battery mode power output	0-80%
Working temperature	-4 to 113° F (-20 to 45°C)
Protection level	IP20
LED lifetime	Up to 50,000 hours
Weight	38.6lbs (17.5kg)
Dimensions	28.4in x 20.4in x 7.2in (72x51.8x18.2cm)

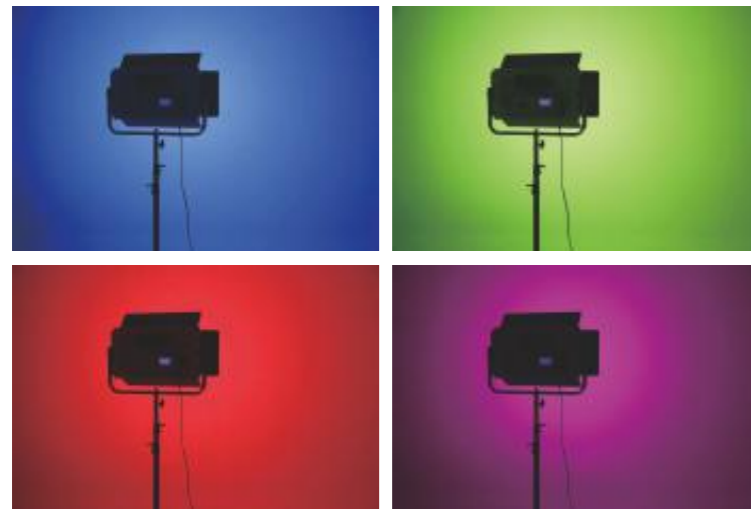

HS-700R



LED diffusion	Lishuai Huescape Technology
Front diffuser panel	φ 40.7cm
Beam angle	120°
Color light	Full RGB+W gamut with hue saturation control
Dimming	0-100% continuous
White light	Continuously adjustable 2800K to 10000K
CRI, TLCI	CRI ≥ 95, TLCI ≥ 91
Color temperature error	± 200K
Remote control	DMX 512, Remote control, Mobile APP
Power input	AC100-240V, 50/60Hz, DC15V
Power output	100W max
Battery mount	V-lock plate
Battery voltage	DC12-17V
Battery mode power output	0-80%
Working temperature	-4 to 113° F (-20 to 45°C)
Protection level	IP20
LED lifetime	Up to 50,000 hours
Weight	7.78lbs (3.53Kg) without adapter, 9.41lbs (4.27Kg) with adapter
Dimensions	20in x 22in x 3in (51x56x7.5cm)

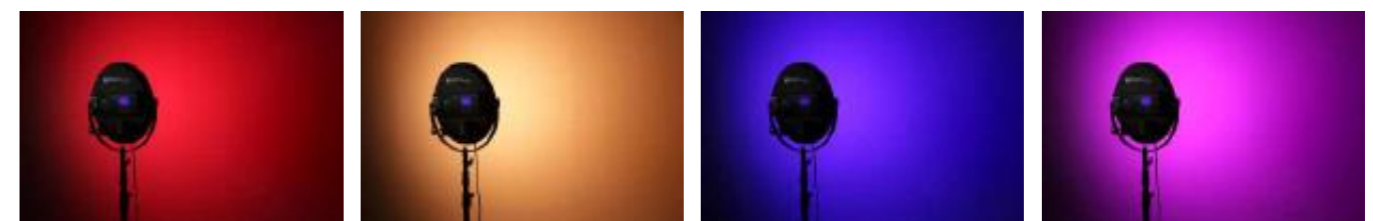

- ✓ Scene simulation
- ✓ RGB color output
- ✓ Mobile APP remote control
- ✓ High CRI



HIGH POWER LED PANEL LIGHT

High Power LED Panel Light

LISHUAI FILM & TELEVISION EQUIPMENT

C200

NEW



LED	1200pcs of ultra bright LEDs
Illuminance	2672Lux/1m, 747Lux/2m
Beam angle	120°
Color temperature	2800 ± 150K ~6500 ± 300K
CRI,TLCI	≥96
Output power	120W
Working voltage	AC100-240V, DC15V
Dimension	63x13x44cm
Weight	4.9kg
Accessories included	AC power adapter 144W, Barndoor, Power cord, DMX cable, Safety cable
Accessories for option	Honeycomb grid, Soft bag



HIGH POWER LED PANEL LIGHT



C400

LED	2400pcs of ultra bright LEDs
Illuminance	4146Lux/1m, 1244Lux/2m
Beam angle	120°
Color temperature	2800 ± 150K ~ 6500 ± 300K
CRI, TLCI	≥96
Output power	200W
Working voltage	AC100-240V, DC25.6V-33.6V
Dimension	105.6x33.5x13.3cm
Weight	10.5kg
Accessories included	Barndoor, Power cord, DMX cable, Safety cable
Accessories for option	Honeycomb grid, Soft bag

Main Features

- High CRI ≥ 96 and TLCI ≥ 96.
- LCD displays brightness, color temperature and DMX address in real time.
- Brightness dimmable from 10% to 100% and color temperature adjustable from 2800K to 6500K.
- Wide beam angle 120°, larger lighting area.
- DMX function available.
- Using all-aluminum frame, for better heat dissipation.
- Both AC power supply and battery power supply are workable.



HIGH POWER LED PANEL LIGHT

P-1580ASVL

Main Features

- High CRI:95-98 and TLCI ≥ 95.
- LCD displays brightness, color temperature and DMX address in real time.
- Brightness dimmable from 10% to 100% and color temperature adjustable from 3200K to 5600K.
- Wide beam angle 120°, larger lighting area.
- DMX function available.
- Using all-aluminum frame, for better heat dissipation.
- Both AC power supply and battery power supply are workable.



LED	1200pcs of ultra bright LEDs
Illuminance	2565Lux/1m, 935Lux/2m
Beam angle	120°
Color temperature	3200 ± 150K ~ 5600 ± 300K
CRI	Ra: 95-98
TLCI	≥95
Output power	120W
Working voltage	AC100-240V, DC12-24V
Dimension	61.5x49x9.5cm
Weight	5.42kg
Accessories included	AC power adapter 144W, Barndoor, Power cord, DMX cable, Safety cable
Accessories for option	Honeycomb grid, Soft bag



HIGH POWER LED PANEL LIGHT



P-1380AVL,P-1380ASVL

Size	63x13x44cm
Weight	4.9kg
Power	100W
Voltage range	AC100V-240V, DC15V
Color temperature	P-1380AVL: 5600K(±300K) P-1380ASVL: 3200K(±150K)-5600K(±300K)
Illuminance	2450Lux/m, 670Lux/2m
Accessories	AC power adapter, Barndoor, DMX cable, Safety cable, Power cord



P-1380A(S)VLK-2

- 2 x P-1380A(S)VL
- 2 x Barndoors
- 2 x AC power adapter
- 2 x Power cord
- 2 x DMX cable
- 2 x Safety cable
- 4 x Velcro strap
- 1 x Aluminum case



P-2400AVL,P-2400ASVL

Size	105.6x33.5x13.3cm
Weight	10.5kg
Power	200W
Voltage range	AC100V-240V or DC25.6V-33.6V
Color temperature	P-2400AVL: 5600K ± (300K) P-2400ASVL: 3200K(±150K)-5600K(±300K)
Illuminance	4912Lux/1m, 1167Lux/2m
Accessories	Barndoor, DMX cable, Safety cable, Power cord



LISHUAI FILM & TELEVISION EQUIPMENT



Victorsoft High Power LED Light



VictorSoft 1x1

V-2000ASVL

Size	45X55X9cm
Weight	6.4kg
Power	100W
Voltage	AC100V-240V, DC15V
Color temperature	3200K(±150K)~5600K(±300K)
Illuminance	2565Lux/m, 685Lux/2m
Accessories	Barndoor, AC power adapter, Power cord, DMX cable, Safety cable



VictorSoft 1x2

V-4000ASVL

Size	70X55X9cm
Weight	9.09kg
Power	200W
Voltage	AC100V-240V, DC24V-30V
Color temperature	3200K(±150K)~5600K(±300K)
Illuminance	4695Lux/m, 1425Lux/2m
Accessories	Barndoor, AC power adapter, Power cord, DMX cable, Safety cable



VictorSoft 1x4

V-6000ASVL

Size	38X117.5X15cm
Weight	15.27kg
Power	300W
Voltage	AC100V-240V, DC24V-30V
Color temperature	3200K(±150K)~5600K(±300K)
Illuminance	7430Lux/m, 2185Lux/2m
Accessories	Barndoor, AC power adapter, Power cord, DMX cable, Safety cable



VictorSoft 12

VR-1200ASVL

Size	40.5X46X9.5cm
Weight	3.7kg
Power	55W
Voltage	AC100V-240V, DC13V-17V
Color temperature	3200K(±150K)~5600K(±300K)
Illuminance	1582Lux/m, 422Lux/2m
Accessories	AC power adapter, Power cord, DMX cable, Safety cable



VictorSoft 18

VR-2500ASVL

Size	55X60X9.5cm
Weight	6.7kg
Power	100W
Voltage	AC100V-240V, DC13V-17V
Color temperature	3200K(±150K)~5600K(±300K)
Illuminance	2867Lux/m, 779Lux/2m
Accessories	AC power adapter, Power cord, DMX cable, Safety cable





LISHUAI FILM & TELEVISION EQUIPMENT

LED Edge Light

LED EDGE LIGHT



C-700RSV

Size	φ 520x50mm
Weight	2.85kg
Power	60W
Voltage range	DC14.8V -16.8V
Color temperature	3200K(±200K)~5600K(±300K)
Illuminance	1065Lux/m, 350Lux/2m
Accessories	6600mAh Battery, Battery charger, AC power adapter, Power cord, Safety cable, Carrying case



C-1500RSV

- Features**
- Ultra- large round design, giving large lighting area.
 - It adopts SMD LED, with soft and even light, much more like natural light.
 - Elegant slim design.
 - Aluminum housing, perfect heat dissipation.

Size	φ 800x87mm
Weight	9.23kg
Power	120W
Voltage range	AC100V~240V, DC13V~17V
Color temperature	3200K(±150K)~5600K(±300K)
Illuminance	1900Lux/m, 655Lux/2m
Accessories	AC power adapter, Power cord, Safety cable



C-1180ASV

Size	1260x292x95mm
Weight	7.3kg
Power	AC100V~240V, DC13V~17V
Voltage range	100W
Color temperature	3200K(±150K)~5600K(±300K)
Illuminance	3116Lux/0.5m, 1275Lux/m (3200K) 3535Lux/0.5m, 1458Lux/m (5600K)
Accessories	Barndoor, AC power adapter, Power cord, Safety cable, Carrying case



C-518ASV

Size	365x400x50mm
Weight	2.08kg
Power	40W
Voltage range	DC14.8V -16.8V
Color temperature	3200K(±200K)~5600K(±300K)
Illuminance	2000Lux/0.5m, 623Lux/m
Accessories	4400mAh battery, Battery charger, AC power adapter, Power cord, Safety cable, Carrying case



C-300RS

Size	φ260x46mm
Weight	0.74kg
Power	30W
Voltage range	DC7.4V - 14.8V
Color temperature	3200K(±200K)~5600K(±300K)
Illuminance	2050Lux/0.5m, 570Lux/m
Accessories	4400mAh battery, Battery charger, Car charger, Carrying case, AC poweradapter, power cord

LED EDGE LIGHT

LED FOLDABLE LIGHT



C-208AS

Size	204x124x46mm
Weight	418.9g
Power	16W
Voltage range	DC7.4V -14.8V
Color temperature	3200K(±200K)~5600K(±300K)
Illuminance	790Lux/0.5m, 212Lux/m
Accessories	Battery, Battery charger, Ballhead, Car charger, Carrying case



C-218AS

Size	284x104x46mm
Weight	472.7g
Power	16W
Voltage range	DC7.4V - 14.8V
Color temperature	3200K(±200K)~5600K(±300K)
Illuminance	770Lux/0.5m, 218Lux/m
Accessories	Battery, Battery charger, Ballhead, Car charger, Carrying case



C-200RS

Size	Φ 178x46mm
Weight	411.4g
Power	16W
Voltage range	DC7.4V -14.8V
Color temperature	3200K(±200K)~5600K(±300K)
Illuminance	1050Lux/0.5m, 286Lux/m
Accessories	Battery, Battery charger, Ballhead, Car charger, Carrying case



C-318RLS

Size	Φ260x50mm
Weight	850g
Power	30W
Voltage range	DC7.4V -14.8V
Color temperature	3200K(±200K)~5600K(±300K)
Illuminance	900Lux/0.5m, 273Lux/m
Accessories	4400mAh battery, Battery charger, AC power adapter, Power cord, Carrying case, rod mounting for shoulder rig, yoke



FL50BI

FL50K-2 Lighting kit

- FL50BI x 2pcs
- Power control box x 2pcs
- Soft diffuser x 2pcs
- Metal mounting plate x 2pcs
- DC power cable x 2pcs
- AC power cable x 2pcs
- Kit bag x 1pc

FL50K-3 Lighting kit

- FL50BI x 3pcs
- Power control box x 3pcs
- Soft diffuser x 3pcs
- Metal mounting plate x 3pcs
- DC power cable x 3pcs
- AC power cable x 3pcs
- Kit bag x 1pc



FL70BI

FL70K-2 Lighting kit

- FL70BI x 2pcs
- Power control box x 2pcs
- Soft diffuser x 2pcs
- Metal mounting plate x 2pcs
- DC power cable x 2pcs
- AC power cable x 2pcs
- Kit bag x 1pc

FL70K-3 Lighting kit

- FL70BI x 3pcs
- Power control box x 3pcs
- Soft diffuser x 3pcs
- Metal mounting plate x 3pcs
- DC power cable x 3pcs
- AC power cable x 3pcs
- Kit bag x 1pc



FL50BI, FL70BI

MODEL	FL50BI	FL70BI
LED	256pcs ultra bright chip LEDs	396pcs ultra bright chip LEDs
Illuminance	2800K: 1300Lux/1m, 352Lux/2m	2800K: 1816Lux/1m, 496Lux/2m
	6500K: 1439Lux/1m, 379Lux/2m	6500K: 2036Lux/1m, 539Lux/2m
Beam angle	120°	
Color temperature	2800 ± 150K ~ 6500 ± 200K	
CRI	Ra: 96-98	
TLCI	≥96	
Power	50W	70W
Working voltage	AC100-240V, DC13-17V	
Dimension (for light body)	13.2x13.2x0.8in (33.5x33.5x2cm)	20.9x12x0.8in (53x30.5x2cm)
Dimension (for power control box)	9.3x5.5x2.7in (23.5x14x6.9cm)	
Weight (for light body)	3.08lbs (1.4kg)	3.63lbs (1.65kg)
Weight (for Power control box)	2.87lbs(1.3kg)	
Accessories	Soft diffuser, AC power cable, DC power cable, Metal mounting plate, Remote control, bag, Power control box	





HS-50



HS-70

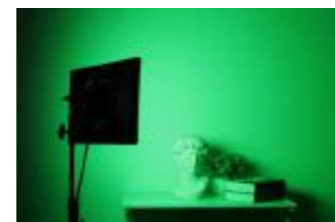

FL150,FL150L



FL150



FL150L



HS-50,HS-70

SPEC	MODEL	HS-50	HS-70
Optical system		Soft diffuser panel	
Front diffuser panel		30x30cm	49x26.5cm
Beam angle		120°	
Color light		Full RGB+ WT color gamut with hue saturation control	
Dimming		10-100% continuous dimmable	
White light		2800K-10000K color temperature continuous adjustable	
CRI		93-98	
TLCI		95-97	
Color temperature error		± 200K	
Power input		AC100-240V, 50/60HZ,DC13-17V	
Working temperature		-20°C-45°C	
Protection level		IP20	
LED lifetime		50000 hrs approx.	
Power output		50W	70W
Dimension		13.2x13.2x0.8in(33.5x33.5x2cm)	20.9x12x0.8in(53x30.5x2cm)
Dimension(for Power control box)		10.4x5.7x3.35in(26.4x14.1x8.5cm)	
Weight		3.1Lbs(1.4kg)	3.63Lbs(1.65kg)
Weight (for Power control box)		3.35Lbs(1.52kg)	
Accessories		White diffuser, Power control box, Metal mounting plate, AC power cable, DC power cable, bag	
Optional accessory		Remote control	

MODEL	FL150	FL150L
LED	784pcs ultra bright chip LEDs	
ILLUMINANCE	2800K: 3500Lux/1m, 1020Lux/2m 6500K: 4040Lux/1m,1180Lux/2m	2800K: 3220Lux/1m, 1000Lux/2m 6500K: 3850Lux/1m, 1170Lux/2m
Beam angle	120°	
Color temperature	2800 ± 150K ~ 6500 ± 200K	
CRI	Ra: 96-98	
TLCI	≥96	
Power	150W	
Working voltage	AC100-240V, DC13-17V	
Dimension (for unfolded light body)	20.4x22x1.2in (52x56x3cm)	40.1x11.8x1.2in (102x30x3cm)
Dimension (for folded light body)	20.4x11.4x1.9in (52x29x4.8cm)	20.4x11.8x1.9in (52x30x4.8cm)
Dimension (for power control box)	5.6x10.6x3.27in(14.2x27x8.3cm)	
Weight (for light body)	6.5 lbs (2.96kg)	6 lbs (2.75kg)
Weight (for Power control box)	3.36 lbs(1.525kg)	
Accessories	Softbox, Power control box, Ball head bracket, DC power cable, AC power cable, Remote control,Carrying case	
Optional accessories	Grid	

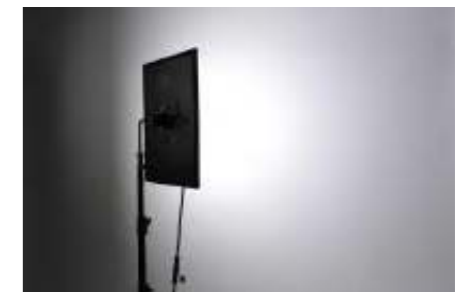

HS-Q150



Name	HS-Q150
Optical system	Diffusion panel
Light emission surface	19.3x20.9in(49x53cm)
Beam angle	120°
Color	Full RGB+WT spectrum with hue saturation control
Intensity / Brightness	Continuously adjustable 0-100%
White light	Adjustable 2800K-10000K
CRI	93-98
TLCI	95-97
Color temperature error	± 200K
Remote control	DMX 512, Remote control, Mobile APP
Power input	AC100-240V, 50/60Hz, DC13-17V
Power output	150W
Working temperature	-20°C-45°C
Protection	IP20
LED lifetime	50,000 hours
Dimension for unfolded light body	20.4x22x1.2in (52x56x3cm)
Dimension for folded light body	20.4x11.4x1.9in (52x29x4.8cm)
Dimension for power control box	15x5.6x3.2in (38x14.2x8.3cm)
Weight for light body	6.8 lbs (3.12kg)
Weight for power control box	4 lbs (1.825kg)
Accessories	Softbox, Power control box, Ball head bracket, DC power cable (control box to light unit), Power cable, DMX cable, Carrying case
Optional accessories	Remote control, Grid



HS-Q150L



Name	HS-Q150L
Optical system	Diffusion panel
Light emission surface	38.8x10.2in(98.5x26cm)
Beam angle	120°
Color	Full RGB+WT spectrum with hue saturation control
Intensity/ Brightness	Continuously adjustable 0-100%
White light	Adjustable 2800K-10000K
CRI	93-98
TLCI	95-97
Color temperature error	± 200K
Remote control	DMX 512, Remote control, Mobile APP
Power input	AC100-240V, 50/60Hz, DC13-17V
Power output	150W
Working temperature	-20°C-45°C
Protection	IP20
LED lifetime	50,000 hours
Dimension for unfolded light body	40.1x11.8x1.2in (102x30x3cm)
Dimension for folded light body	20.4x11.8x1.9in (52x30x4.8cm)
Dimension for power control box	14.9x5.5x3.2in (38x14.2x8.3cm)
Weight for light body	6.8 lbs (3.12kg)
Weight for power control box	4 lbs (1.825kg)
Accessories	Softbox, Power control box, Ball head bracket, DC power cable (control box to light unit), Power cable, DMX cable, Carrying case
Optional accessories	Remote control, Grid



FL1500R

LED	LED2044pcs of ultra bright chip
Illuminance	2800K: 6680Lux/1m, 2080Lux/2m
	6500K: 6720Lux/1m, 2120Lux/2m
Beam angle	120°
Color temperature	2800 ± 150K ~ 6500 ± 200K
CRI	Ra:96-98
TLCI	≥96
Power	260W
Working voltage	AC100-240V, DC24-30V
Dimension for unfolded light body	φ 35.4x12in (φ 90x30cm)
Dimension for folded light body	35.4x18.1x1.9in (90x46x4.8cm)
Dimension for power control box	5.6x18.9x3.3in (14.2x48x8.3cm)
Weight for light body	13.7lbs (6.2kg)
Weight for power control box	7.9lbs (3.6kg)
Accessories	Softbox, Power control box, Ball head bracket, DC power cable, AC power cable, Carrying case, Remote control



[Characteristics:]

- High CRI 96-98 and TLCI ≥96
- Foldable, easy to carry.
- External battery can be equipped on power control box, convenient for outdoor use.
- LCD shows real-time brightness and color temperature.
- The solid metal ballhead bracket makes it possible to adjust the light freely.
- Brightness dimmable from 10% to 100% and color temperature adjustable from 2800K to 6500K.
- Suitable for indoor and outdoor photography and videography, studio or location shooting.

HS-1500R

Optical system	Diffusion panel
Light emission surface	φ 35.4in (φ 90cm)
Beam angle	120°
Color	Full RGB+WT spectrum with hue saturation control
Intensity / Brightness	Continuously adjustable 0-100%
White light	Adjustable 2800-10000K
CRI	93-98
TLCI	95-97
Color temperature error	± 200K
Remote control	DMX 512, Remote control, Mobile APP
Power input	AC100-240V, 50/60Hz, DC13-24V
Power output	260W
Working temperature	-20°C-45°C
Protection	IP20
LED lifetime	50,000 hours
Dimension for unfolded light body	φ 35.4x12in (φ 90x30cm)
Dimension for folded light body	35.4x18.1x1.9in (90x46x4.8cm)
Dimension for power control box	5.6x14.9x4.2in (14.2x38x10.6cm)
Weight for light body	14.5lbs (6.585kg)
Weight for power control box	7.8lbs (3.52kg)
Accessories	Softbox, Power control box, Ball head bracket, DC power cable (control box to light unit), Power cable, DMX cable, Carrying case
Optional accessories	Remote control



[Characteristics:]

- Standardized color temperature with a CRI 93-98 and TLCI 95-97.
- 0-360° HSI color selection (RGB+WT color gamut).
- Multiple pre-programmed scenes and effects.
- Flicker-free and uniformly dimmable from 0% to 100%.
- Color temperature is adjustable from 2800K to 10000K.
- This easy to carry, foldable light is made of PC hollow material with a metal heat sink. It is designed with a metal edge for enhanced durability.
- The solid metal ball head bracket allows the light to be securely mounted and easily adjusted.
- USB for future firmware updates and feature additions.
- Easy to use softbox featuring a snap-on design.
- Provides stable, consistent output while remaining heat free.
- DMX512 compatible
- Mobile APP is available to adjust various parameters of the light.
- Suitable for indoor and outdoor photography and videography. Great for studio or location shoots including TV, film, portrait photography, etc.



LISHUAI FILM & TELEVISION EQUIPMENT

LED PANEL LIGHT

LED PANEL LIGHT



LED800X

Light size	35.9x23.4x7.7cm
Overall size	41.9x43.8x7.7cm
Beam angle	60°
Weight	2.57kg(w/o barndoor),3.14kg(w/barndoor)
Power	80W
Voltage	AC100V-240V, DC12V-17V
Color temperature	3200K(±200K)~5600K(±300K)
Illuminance	5600K:2560Lux/1m,690Lux/2m 3200K:2200Lux/1m,590Lux/2m
Accessories	Barndoor,Diffusion panel,White diffusion panel, AC power adapter 12V 60W,Remote controller, Safety cable,Power cord,Carrying case



LED650AS

Light size	35.9x23.4x7.2cm
Overall size	41.9x43.8x7.2cm
Beam angle	45°
Weight	2.19kg(w/o barndoor),2.76kg(w/barndoor)
Power	39W
Voltage	DC12V-17V
Color temperature	3200K(±200K)~5600K(±300K)
Illuminance	1877Lux/m,516Lux/2m(5600K) 1523Lux/m,430Lux/2m(3200K)
Accessories	2200mAh lithium battery,Battery charger, Charger adapter 12V 1A,AC power adapter 12V 40W,Safety cable, Power cord



LED680ASV

Light size	35.9x23.4x7.2cm
Overall size	41.9x43.8x7.2cm
Beam angle	45°
Weight	2.57kg(w/o barndoor),3.14kg(w/barndoor)
Power	39W
Voltage	AC100V-240V, DC12V-17V
Color temperature	3200K(±200K)~5600K(±300K)
Illuminance	2370Lux/m,665Lux/2m(5600K) 1946Lux/m,528Lux/2m(3200K)
Accessories	Barndoor,Diffusion panel,AC power adapter 12V 40W,Remote controller,Safety cable, Power cord



LED1300ASV

Light size	35.9x38.9x7.7cm
Overall size	41.9x52.1x7.7cm
Beam angle	45°
Weight	3.47kg(w/o barndoor),4.44kg(w/barndoor)
Power	78W
Voltage	AC100V-240V, DC12V-17V
Color temperature	3200K(±200K)~5600K(±300K)
Illuminance	4330Lux/m,1247Lux/2m(5600K) 3825Lux/m,1076Lux/2m(3200K)
Accessories	Barndoor,Diffusion panel,AC power adapter 15V 60W,DMX cable,Safety cable,Power cord



LISHUAI FILM & TELEVISION EQUIPMENT



Lens Adapter: 49mm 52mm 55mm 58mm
62mm 67mm 72mm 77mm

LED48A

Size	149x114x26mm
Weight	129g
Power	2.88W
Voltage	DC5V - 14.8V
Color temperature	5600K(±300K) or 3200K(±200K)
Illuminance	650Lux/0.5m, 180Lux/m



LED98A

Size	121x78x35mm
Weight	140g
Voltage	DC7.4V - 14.8V
Power	5.88W
Color temperature	5600K(±300K)
Illuminance	450Lux/m
Power supply	Lithium battery



LED144AS

Size	135x85x35mm
Weight	200g
Power	8.64W
Voltage	DC7.4V - 14.8V
Color temperature	3200K(±200K)-5600K(±300K)
Illuminance	352Lux/m(3200K) 352Lux/m(5600K)



LED209AS

Size	158x105x35mm
Weight	230g
Power	12.54W
Voltage	DC7.4V - 14.8V
Color temperature	5600K(±300K) or 3200K(±200K) 3200K(±200K)~5600K(±300K)
Illuminance	460Lux/m(3200K) 540Lux/m(5600K)



LED312AS















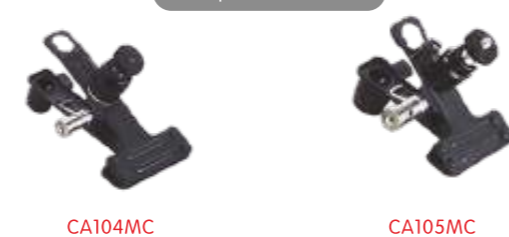







Size	190x115x35mm
Weight	350g
Power	18.72W
Voltage	DC7.4V - 14.8V
Color temperature	5600K(±300K) or 3200K(±200K) 3200K(±200K)~5600K(±300K)
Illuminance	796Lux/m(3200K) 822Lux/m(5600K)



LED312DS

Size	201x123x55mm
Weight	400g
Power	18.72W
Voltage	DC7.4V - 14.8V
Color temperature	3200K(±200K)~5600K(±300K)
Illuminance	1100Lux/m(3200K), 1530Lux/m(5600K)

ACCESSORIES









<p>Ball head</p>  <p>CA100 CA101A CA101B CA102B CA109A</p>				
<p>Hotshoe Adapter</p>  <p>CA103A</p>	<p>Adapter</p>  <p>CA106</p>	<p>Atom Clamp</p>  <p>CA107</p>	<p>Clamp with Ball Head</p>  <p>CA104MC CA105MC</p>	
<p>Hotshoe Base</p>  <p>CA108</p>	<p>Super Clamp</p>  <p>CA114</p>	<p>Adjustable Gaffer Clamp</p>  <p>CA111</p>	<p>Adjustable Gaffer Clamp 5/8" Pin & 5/8" Receiver</p>  <p>CA115</p>	<p>Clamp</p>  <p>CA113</p>
<p>Pelican Gaffer Grip 5/8" Pin & 5/8" Receiver</p>  <p>CA116</p>	<p>Pipe Clamp 5/8" Pin</p>  <p>CA118</p>	<p>Swiveling Pipe Clamp</p>  <p>CA39B</p>	<p>Magic arm</p>  <p>CA1950 -Length: 19.5cm -Weight: 195g</p>	<p>Magic arm</p>  <p>CA2800 -Length: 28cm -Weight: 250g</p>
<p>Articulated Arm</p>  <p>CA1020</p>	<p>Articulated Arm</p>  <p>CA2550</p>	<p>2" End Jaw Clamp with 5/8" Pin & Hex socket</p>  <p>CA1120A</p>	<p>6" End Jaw Clamp with 5/8" Pin</p>  <p>CA1132B</p>	<p>3" End Jaw Clamp with 5/8" Pin</p>  <p>CA1120E</p>
<p>10" End Jaw Clamp with 5/8" Pin & Hex socket</p>  <p>CA1142C</p>	<p>7" End Jaw Clamp with 5/8" Pin & Hex socket</p>  <p>CA1132D</p>	<p>Stud</p> <p>1/4" & 3/8"</p>	<p>Camera bracket</p>  <p>Cm280 Length: 28cm Cm150 Length: 15cm</p>	









ACCESSORIES









<p>Battery Mount Plate</p>  <p>ZJ-01 SV001 AB002</p>	<p>Cable</p>  <p>D-TAP</p>	<p>130W/H Battery & Charger</p>  <p>SV130</p>
<p>Locking Wheel Set</p>  <p>M11-016</p>	<p>Mini Stand</p>  <p>CA072 CA072A</p>	









Accessories for LED Sport Light

<p>RB28 28X19cm with Bowens mount</p> 	<p>RP20 19.8X17.8cm with Profoto mount</p> 	<p>LD20 Ø20X6cm, 120degree, with Bowens mount</p> 
<p>RP27 27X27cm with Profoto mount</p> 	<p>RB39 Depth 39cm, with Bowens mount</p> 	<p>BS-M18 18X24cm for Bowens adapter</p> 
<p>AD-B12 12X6cm J-500V2 adapter with Bowens mount</p> 	<p>AD-PB13 13X10cm Light adapter with Profoto and Bowens mount</p> 	<p>LD41 41cm with Bowens mount</p> 

<p>LS-320T</p> <p>Section 3</p> <ul style="list-style-type: none"> 323cm 138cm 120cm 2.7kg 5kg 	<p>LS-300T</p> <p>Section 3</p> <ul style="list-style-type: none"> 300cm 122cm 104cm 2.1kg 5kg 	<p>LS-280T</p> <p>Section 4</p> <ul style="list-style-type: none"> 280cm 96cm 84cm 1.8kg 3kg 
<p>LS-260T</p> <p>Section 3</p> <ul style="list-style-type: none"> 260cm 106cm 91cm 1.7kg 4kg 	<p>LS-220T</p> <p>Section 4</p> <ul style="list-style-type: none"> 220cm 78.5cm 69cm 1.5kg 3kg 	<p>LS-200T</p> <p>Section 3</p> <ul style="list-style-type: none"> 200cm 81cm 71cm 1kg 2.5kg 
<p>LS-256T</p> <p>Section 3</p> <ul style="list-style-type: none"> 256cm 109cm 98cm 2.2kg 6kg 	<p>LS-288T</p> <p>Section 3</p> <ul style="list-style-type: none"> 280cm 100cm 95.5cm 2.8kg 4kg 	<p>LS-60T</p> <p>Section 2</p> <ul style="list-style-type: none"> 60cm 36.5cm 10.5cm 1.05kg 5kg 

<p>LS-1700T</p> <p>Section 4</p> <ul style="list-style-type: none"> 170cm 55cm 55cm 1.18kg 3kg 	<p>LS-2000T</p> <p>Section 3</p> <ul style="list-style-type: none"> 200cm 48.5cm 48.5cm 1.1kg 2.5kg 	<p>LS-2100T</p> <p>Section 4</p> <ul style="list-style-type: none"> 215cm 59cm 59cm 1.5kg 5kg 
<p>LS-190S</p> <p>Section 4</p> <ul style="list-style-type: none"> 198cm 95cm 75cm 1.25kg 2.5kg 	<p>LS-250S</p> <p>Section 3</p> <ul style="list-style-type: none"> 250cm 110cm 92cm 1.65kg 2.5kg 	<p>LS-200G</p> <p>Section 4</p> <ul style="list-style-type: none"> 200cm 62cm 50cm 1.3kg 2.5kg 
<p>LS-220G</p> <p>Section 3</p> <ul style="list-style-type: none"> 222cm 62cm 49cm 1.5kg 2.5kg 	<p>LS-35F</p> <p>Section 3</p> <ul style="list-style-type: none"> 35cm 35cm 53cm 5.2kg 30kg 	<p>LS-220F</p> <p>Section 3</p> <ul style="list-style-type: none"> 220cm 131cm 121cm 6kg 10kg 

<p>LS-226F</p> <p>Section 4</p> <ul style="list-style-type: none"> 226cm 115cm 93cm 11.5kg 15kg 	<p>LS-320F</p> <p>Section 3</p> <ul style="list-style-type: none"> 310cm 125cm 118cm 5.5kg 10kg 	<p>LS-580F</p> <p>Section 3</p> <ul style="list-style-type: none"> 583.5cm 195cm 180cm 18kg 20kg 
<p>C stand C-328</p> <p>Section 3</p> <ul style="list-style-type: none"> 328cm 145cm 145cm 7.5kg 10kg 	<p>LS-280LS</p> <p>Section 3</p> <ul style="list-style-type: none"> 284cm 130cm 105cm 4.6kg 8kg 	<p>LS-300Y</p> <p>Section 4</p> <ul style="list-style-type: none"> 300cm 90cm 90cm 2.4kg 3kg 
<p>LS-380Y</p> <p>Section 4</p> <ul style="list-style-type: none"> 380cm 130cm 115cm 3.28kg 10kg 	<p>LS-390B</p> <p>Section 4</p> <ul style="list-style-type: none"> 395cm 132cm 114cm 3.58kg 3kg 	<p>LS-490B</p> <p>Section 5</p> <ul style="list-style-type: none"> 492cm 136cm 119cm 4.3kg 4kg 

<p>LS-400BS</p> <p>Section 5</p> <ul style="list-style-type: none"> 408cm 149cm 142cm 18.8kg 10kg 	<p>LS-530BS</p> <p>Section 5</p> <ul style="list-style-type: none"> 532cm 168cm 172cm 22.1kg 10kg 	<p>LS-210FS</p> <p>Section 3</p> <ul style="list-style-type: none"> 210cm 107cm 107cm 6.3kg 12kg 
<p>LS-310FS</p> <p>Section 3</p> <ul style="list-style-type: none"> 310cm 140cm 140cm 8kg 12kg 	<p>LS-410FS</p> <p>Section 4</p> <ul style="list-style-type: none"> 410cm 144cm 144cm 8.3kg 12kg 	<p>LS-340FS</p> <p>Section 3</p> <ul style="list-style-type: none"> 340cm 148.2cm 134cm 8.25kg 40kg 
<p>BM-370</p> <p>Section 2</p> <ul style="list-style-type: none"> 370cm 224cm 224cm 23.4kg 30kg 	<p>BS-280 2 x 280cm light stand(with adapter) 1 x 3m cross bar 1 x kit bag</p> <p>BS-300 2 x 300cm light stand(with adapter) 1 x 3m cross bar 1 x kit bag</p> 	

BAG & CASE



B2000



B4000



B6000



C5183



B13801



C13802



B280/B288



B300-3



CC16

inner diameter : 80x31x24cm
outer diameter : 88x35x28cm



CC06

inner diameter : 103x34x25cm
outer diameter : 110x38x30cm



CC02

inner diameter : 124x34x22cm
outer diameter : 139x39x31cm